

# HP 40gs graphing calculator

---

## user's guide

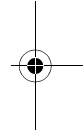
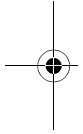

Edition 1  
Part Number F2225AA-90001

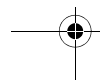
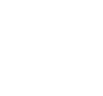
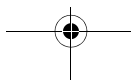

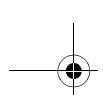

## Notice

**REGISTER YOUR PRODUCT AT: [www.register.hp.com](http://www.register.hp.com)**

**THIS MANUAL AND ANY EXAMPLES CONTAINED HEREIN ARE PROVIDED "AS IS" AND ARE SUBJECT TO CHANGE WITHOUT NOTICE. HEWLETT-PACKARD COMPANY MAKES NO WARRANTY OF ANY KIND WITH REGARD TO THIS MANUAL, INCLUDING, BUT NOT LIMITED TO, THE IMPLIED WARRANTIES OF MERCHANTABILITY, NON-INFRINGEMENT AND FITNESS FOR A PARTICULAR PURPOSE.**

**HEWLETT-PACKARD CO. SHALL NOT BE LIABLE FOR ANY ERRORS OR FOR INCIDENTAL OR CONSEQUENTIAL DAMAGES IN CONNECTION WITH THE FURNISHING, PERFORMANCE, OR USE OF THIS MANUAL OR THE EXAMPLES CONTAINED HEREIN.**

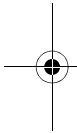

© Copyright 1994-1995, 1999-2000, 2003, 2006 Hewlett-Packard Development Company, L.P.

Reproduction, adaptation, or translation of this manual is prohibited without prior written permission of Hewlett-Packard Company, except as allowed under the copyright laws.

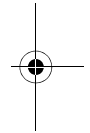

Hewlett-Packard Company  
4995 Murphy Canyon Rd,  
Suite 301  
San Diego, CA 92123

---

## Printing History

Edition 1

April 2005

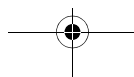



# Contents

---

## Preface

Manual conventions .....	P-1
Notice .....	P-2

## 1 Getting started

On/off, cancel operations.....	1-1
The display .....	1-2
The keyboard .....	1-3
Menus .....	1-8
Input forms .....	1-9
Mode settings.....	1-10
Setting a mode.....	1-11
Aplets (E-lessons).....	1-12
Aplet library .....	1-16
Aplet views.....	1-16
Aplet view configuration.....	1-18
Mathematical calculations.....	1-19
Using fractions.....	1-25
Complex numbers.....	1-29
Catalogs and editors.....	1-30

## 2 Aplets and their views

Aplet views .....	2-1
About the Symbolic view .....	2-1
Defining an expression (Symbolic view) .....	2-1
Evaluating expressions .....	2-3
About the Plot view .....	2-5
Setting up the plot (Plot view setup).....	2-5
Exploring the graph.....	2-7
Other views for scaling and splitting the graph .....	2-13
About the numeric view.....	2-16
Setting up the table (Numeric view setup).....	2-16
Exploring the table of numbers.....	2-17
Building your own table of numbers.....	2-19
"Build Your Own" menu keys.....	2-20
Example: plotting a circle .....	2-20

## 3 Function aplet

About the Function aplet .....	3-1
Getting started with the Function aplet.....	3-1

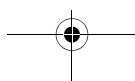
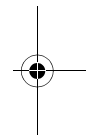
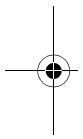



Function aplet interactive analysis .....	3-9
Plotting a piecewise-defined function .....	3-12

## 4 Parametric aplet

About the Parametric aplet .....	4-1
Getting started with the Parametric aplet .....	4-1

## 5 Polar aplet

Getting started with the Polar aplet .....	5-1
--	-----

## 6 Sequence aplet

About the Sequence aplet .....	6-1
Getting started with the Sequence aplet .....	6-1

## 7 Solve aplet

About the Solve aplet .....	7-1
Getting started with the Solve aplet .....	7-2
Use an initial guess .....	7-5
Interpreting results .....	7-6
Plotting to find guesses .....	7-7
Using variables in equations .....	7-10

## 8 Linear Solver aplet

About the Linear Solver aplet .....	8-1
Getting started with the Linear Solver aplet .....	8-1

## 9 Triangle Solve aplet

About the Triangle Solver aplet .....	9-1
Getting started with the Triangle Solver aplet .....	9-1

## 10 Statistics aplet

About the Statistics aplet .....	10-1
Getting started with the Statistics aplet .....	10-1
Entering and editing statistical data .....	10-6
Defining a regression model .....	10-12
Computed statistics .....	10-14
Plotting .....	10-15
Plot types .....	10-16
Fitting a curve to 2VAR data .....	10-17
Setting up the plot (Plot setup view) .....	10-18
Trouble-shooting a plot .....	10-19
Exploring the graph .....	10-19
Calculating predicted values .....	10-20

## 11 Inference aplet

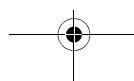
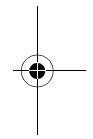
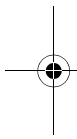



- About the Inference applet ..... 11-1
  - Getting started with the Inference applet ..... 11-1
  - Importing sample statistics from the Statistics applet ..... 11-4
- Hypothesis tests ..... 11-8
  - One-Sample Z-Test..... 11-8
  - Two-Sample Z-Test ..... 11-9
  - One-Proportion Z-Test..... 11-10
  - Two-Proportion Z-Test ..... 11-11
  - One-Sample T-Test ..... 11-12
  - Two-Sample T-Test ..... 11-14
- Confidence intervals ..... 11-15
  - One-Sample Z-Interval ..... 11-15
  - Two-Sample Z-Interval ..... 11-16
  - One-Proportion Z-Interval ..... 11-17
  - Two-Proportion Z-Interval ..... 11-17
  - One-Sample T-Interval ..... 11-18
  - Two-Sample T-Interval..... 11-19

## 12 Using the Finance Solver

- Background..... 12-1
- Performing TVM calculations ..... 12-4
  - Calculating Amortizations..... 12-7

## 13 Using mathematical functions

- Math functions ..... 13-1
  - The MATH menu ..... 13-1
- Math functions by category ..... 13-2
  - Keyboard functions..... 13-3
  - Calculus functions..... 13-6
  - Complex number functions..... 13-7
  - Constants ..... 13-8
  - Conversions ..... 13-8
  - Hyperbolic trigonometry ..... 13-9
  - List functions ..... 13-10
  - Loop functions..... 13-10
  - Matrix functions ..... 13-11
  - Polynomial functions ..... 13-11
  - Probability functions..... 13-12
  - Real-number functions ..... 13-14
  - Two-variable statistics..... 13-17
  - Symbolic functions..... 13-17
  - Test functions ..... 13-19
  - Trigonometry functions ..... 13-20

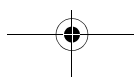



Symbolic calculations .....	13-20
Finding derivatives .....	13-21
Program constants and physical constants .....	13-24
Program constants .....	13-25
Physical constants .....	13-25

## 14 Computer Algebra System (CAS)

What is a CAS? .....	14-1
Performing symbolic calculations .....	14-1
An example .....	14-2
CAS variables .....	14-4
The current variable .....	14-4
CAS modes .....	14-5
Using CAS functions in HOME .....	14-7
Online Help .....	14-8
CAS functions in the Equation Writer .....	14-9
ALGB menu .....	14-10
DIFF menu .....	14-16
REWRI menu .....	14-28
SOLV menu .....	14-33
TRIG menu .....	14-38
CAS Functions on the MATH menu .....	14-45
Algebra menu .....	14-45
Complex menu .....	14-45
Constant menu .....	14-46
Diff & Int menu .....	14-46
Hyperb menu .....	14-46
Integer menu .....	14-46
Modular menu .....	14-51
Polynomial menu .....	14-55
Real menu .....	14-60
Rewrite menu .....	14-60
Solve menu .....	14-60
Tests menu .....	14-61
Trig menu .....	14-61
CAS Functions on the CMDS menu .....	14-62

## 15 Equation Writer

Using CAS in the Equation Writer .....	15-1
The Equation Writer menu bar .....	15-1
Configuration menus .....	15-3
Entering expressions and subexpressions .....	15-5
How to modify an expression .....	15-11

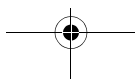
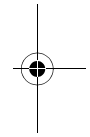
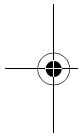



Accessing CAS functions.....	15-12
Equation Writer variables .....	15-16
Predefined CAS variables .....	15-16
The keyboard in the Equation Writer .....	15-17

## 16 Step-by-Step Examples

Introduction .....	16-1
--------------------	------

## 17 Variables and memory management

Introduction .....	17-1
Storing and recalling variables .....	17-2
The VARS menu .....	17-4
Memory Manager.....	17-9

## 18 Matrices

Introduction .....	18-1
Creating and storing matrices.....	18-2
Working with matrices.....	18-4
Matrix arithmetic.....	18-6
Solving systems of linear equations.....	18-8
Matrix functions and commands.....	18-10
Argument conventions.....	18-10
Matrix functions .....	18-10
Examples .....	18-13

## 19 Lists

Displaying and editing lists.....	19-4
Deleting lists .....	19-6
Transmitting lists .....	19-6
List functions .....	19-6
Finding statistical values for list elements .....	19-9

## 20 Notes and sketches

Introduction .....	20-1
Aplet note view.....	20-1
Aplet sketch view .....	20-3
The notepad .....	20-6

## 21 Programming

Introduction .....	21-1
Program catalog .....	21-2
Creating and editing programs.....	21-4
Using programs .....	21-7
Customizing an aplet.....	21-9

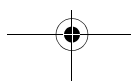
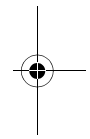
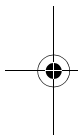



Aplet naming convention .....	21-10
Example .....	21-10
Programming commands .....	21-13
Aplet commands .....	21-14
Branch commands .....	21-17
Drawing commands .....	21-19
Graphic commands .....	21-21
Loop commands .....	21-23
Matrix commands .....	21-24
Print commands .....	21-25
Prompt commands .....	21-26
Stat-One and Stat-Two commands .....	21-29
Stat-Two commands .....	21-30
Storing and retrieving variables in programs .....	21-31
Plot-view variables .....	21-31
Symbolic-view variables .....	21-38
Numeric-view variables .....	21-40
Note variables .....	21-43
Sketch variables .....	21-43

## 22 Extending aplets

Creating new aplets based on existing aplets .....	22-1
Using a customized aplet .....	22-3
Resetting an aplet .....	22-3
Annotating an aplet with notes .....	22-4
Annotating an aplet with sketches .....	22-4
Downloading e-lessons from the web .....	22-4
Sending and receiving aplets .....	22-4
Sorting items in the aplet library menu list .....	22-6

## Reference information

Glossary .....	R-1
Resetting the HP 40gs .....	R-3
To erase all memory and reset defaults .....	R-3
If the calculator does not turn on .....	R-4
Operating details .....	R-4
Batteries .....	R-4
Variables .....	R-6
Home variables .....	R-6
Function aplet variables .....	R-7
Parametric aplet variables .....	R-8
Polar aplet variables .....	R-9
Sequence aplet variables .....	R-10

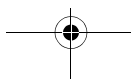





Solve aplet variables.....	R-11
Statistics aplet variables .....	R-12
MATH menu categories .....	R-13
Math functions .....	R-13
Program constants .....	R-15
Physical Constants .....	R-16
CAS functions .....	R-17
Program commands.....	R-19
Status messages.....	R-20

## Limited Warranty

Service.....	W-3
Regulatory Notices .....	W-5

## Index

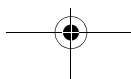
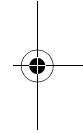
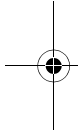

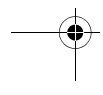
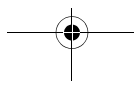
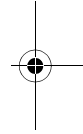
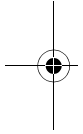
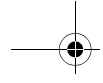



## Preface

---

The HP 40gs is a feature-rich graphing calculator. It is also a powerful mathematics learning tool, with a built-in computer algebra system (CAS). The HP 40gs is designed so that you can use it to explore mathematical functions and their properties.

You can get more information on the HP 40gs from Hewlett-Packard's Calculators web site. You can download customized applets from the web site and load them onto your calculator. Customized applets are special applications developed to perform certain functions, and to demonstrate mathematical concepts.

Hewlett Packard's Calculators web site can be found at:

**<http://www.hp.com/calculators>**

## Manual conventions

The following conventions are used in this manual to represent the keys that you press and the menu options that you choose to perform the described operations.

- Key presses are represented as follows:

`[SIN]`, `[COS]`, `[HOME]`, etc.

- Shift keys, that is the key functions that you access by pressing the `[SHIFT]` key first, are represented as follows:

`[SHIFT] CLEAR`, `[SHIFT] MODES`, `[SHIFT] ACOS`, etc.

- Numbers and letters are represented normally, as follows:

5, 7, A, B, etc.

- Menu options, that is, the functions that you select using the menu keys at the top of the keypad are represented as follows:

`MODE`, `GRAPH`, `DB`.

- Input form fields and choose list items are represented as follows:

Function, Polar, Parametric

- Your entries as they appear on the command line or within input forms are represented as follows:

$2 * X^2 - 3X + 5$

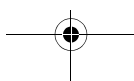
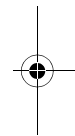
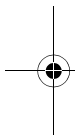

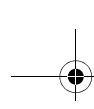

## Notice

This manual and any examples contained herein are provided as-is and are subject to change without notice. Except to the extent prohibited by law, Hewlett-Packard Company makes no express or implied warranty of any kind with regard to this manual and specifically disclaims the implied warranties and conditions of merchantability and fitness for a particular purpose and Hewlett-Packard Company shall not be liable for any errors or for incidental or consequential damage in connection with the furnishing, performance or use of this manual and the examples herein.

© Copyright 1994-1995, 1999-2000, 2003, 2006 Hewlett-Packard Development Company, L.P.

The programs that control your HP 40gs are copyrighted and all rights are reserved. Reproduction, adaptation, or translation of those programs without prior written permission from Hewlett-Packard Company is also prohibited.

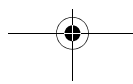
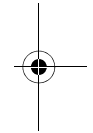
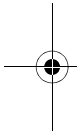

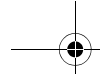

# 1

## Getting started

---

### On/off, cancel operations

#### To turn on

Press **ON** to turn on the calculator.

#### To cancel

When the calculator is on, the **ON** key cancels the current operation.

#### To turn off

Press **SHIFT** *OFF* to turn the calculator off.

To save power, the calculator turns itself off after several minutes of inactivity. All stored and displayed information is saved.

If you see the ((•)) annunciator or the *Low Bat* message, then the calculator needs fresh batteries.

#### HOME

HOME is the calculator's home view and is common to all aplets. If you want to perform calculations, or you want to quit the current activity (such as an aplet, a program, or an editor), press **HOME**. All mathematical functions are available in the HOME. The name of the current aplet is displayed in the title of the home view.

#### Protective cover

The calculator is provided with a slide cover to protect the display and keyboard. Remove the cover by grasping both sides of it and pulling down.

You can reverse the slide cover and slide it onto the back of the calculator. This will help prevent you losing the cover while you are using the calculator.

To prolong the life of the calculator, always place the cover over the display and keyboard when you are not using the calculator.

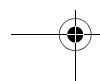
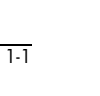
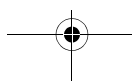
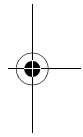
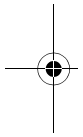

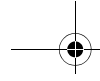

## The display

### To adjust the contrast

Simultaneously press  $\boxed{\text{ON}}$  and  $\boxed{+}$  (or  $\boxed{-}$ ) to increase (or decrease) the contrast.

### To clear the display

- Press *CANCEL* to clear the edit line.
- Press  $\boxed{\text{SHIFT}}$  *CLEAR* to clear the edit line and the display history.

### Parts of the display

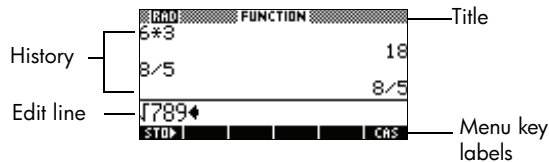

**Menu key or soft key labels.** The labels for the menu keys' current meanings.  $\boxed{\text{STO}}$  is the label for the first menu key in this picture. "Press  $\boxed{\text{STO}}$ " means to press the first menu key, that is, the leftmost top-row key on the calculator keyboard.

**Edit line.** The line of current entry.

**History.** The HOME display ( $\boxed{\text{HOME}}$ ) shows up to four lines of history: the most recent input and output. Older lines scroll off the top of the display but are retained in memory.

**Title.** The name of the current aplet is displayed at the top of the HOME view. RAD, GRD, DEG specify whether Radians, Grads or Degrees angle mode is set for HOME. The  $\blacktriangledown$  and  $\blacktriangle$  symbols indicate whether there is more history in the HOME display. Press the  $\blacktriangledown$  and  $\blacktriangle$  to scroll in the HOME display.

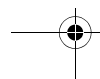
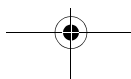
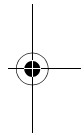
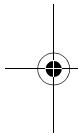



**Annunciators.** Annunciators are symbols that appear above the title bar and give you important status information.

Annunciator	Description
	Shift in effect for next keystroke. To cancel, press <b>SHIFT</b> again.
$\alpha$	Alpha in effect for next keystroke. To cancel, press <b>ALPHA</b> again.
((•))	Low battery power.
	Busy.
	Data is being transferred.

## The keyboard

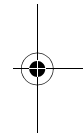
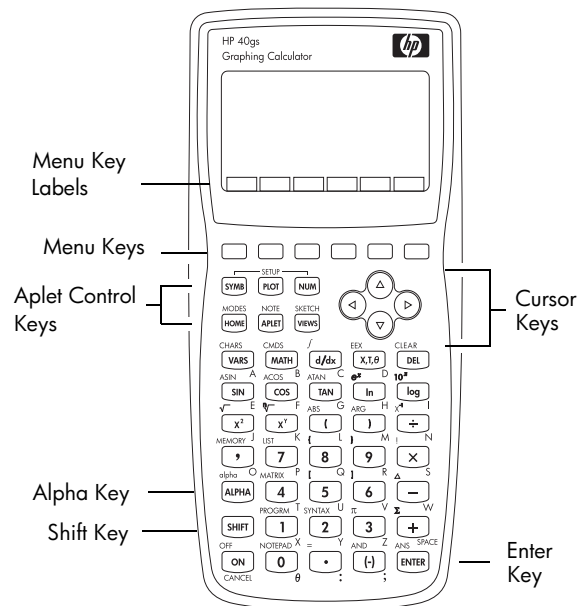
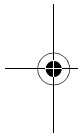









### Menu keys

- On the calculator keyboard, the top row of keys are called menu keys. Their meanings depend on the context—that’s why they are blank. The menu keys are sometimes called “soft keys”.
- The bottom line of the display shows the labels for the menu keys’ current meanings.

### Aplet control keys

The aplet control keys are:



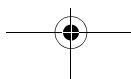
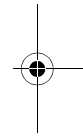
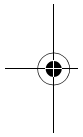





















Key	Meaning
	Displays the Symbolic view for the current aplet. See “Symbolic view” on page 1-16.
	Displays the Plot view for the current aplet. See “Plot view” on page 1-16.
	Displays the Numeric view for the current aplet. See “Numeric view” on page 1-17.
	Displays the HOME view. See “HOME” on page 1-1.
	Displays the Aplet Library menu. See “Aplet library” on page 1-16.
	Displays the VIEWS menu. See “Aplet views” on page 1-16.





## Entry/Edit keys

The entry and edit keys are:

Key	Meaning
 (CANCEL)	Cancels the current operation if the calculator is on by pressing  . Pressing  , then OFF turns the calculator off.
	Accesses the function printed in blue above a key.
	Returns to the HOME view, for performing calculations.
	Accesses the alphabetical characters printed in orange below a key. Hold down to enter a string of characters.
	Enters an input or executes an operation. In calculations,  acts like “=”. When  or  is present as a menu key,  acts the same as pressing  or  .
	Enters a negative number. To enter -25, press  25. <i>Note: this is not the same operation that the subtract button performs ().</i>
	Enters the independent variable by inserting X, T, θ, or N into the edit line, depending on the current active aplet.
	Deletes the character under the cursor. Acts as a backspace key if the cursor is at the end of the line.
 CLEAR	Clears all data on the screen. On a settings screen, for example Plot Setup,  CLEAR returns all settings to their default values.
 ,  ,  , 	Moves the cursor around the display. Press  first to move to the beginning, end, top or bottom.



Key	Meaning (Continued)
<b>SHIFT</b> CHARS	Displays a menu of all available characters. To type one, use the arrow keys to highlight it, and press . To select multiple characters, select each and press  , then press .

### Shifted keystrokes

There are two shift keys that you use to access the operations and characters printed above the keys: **SHIFT** and **ALPHA** .

Key	Description
<b>SHIFT</b>	<p>Press the <b>SHIFT</b> key to access the operations printed in blue above the keys. For instance, to access the Modes screen, press <b>SHIFT</b> , then press <b>HOME</b> . (<i>MODES</i> is labeled in blue above the <b>HOME</b> key). You do not need to hold down <b>SHIFT</b> when you press HOME. This action is depicted in this manual as “press <b>SHIFT</b> <i>MODES</i>.”</p> <p>To cancel a shift, press <b>SHIFT</b> again.</p>
<b>ALPHA</b>	<p>The alphabetic keys are also shifted keystrokes. For instance, to type Z, press <b>ALPHA</b> Z. (The letters are printed in orange to the lower right of each key.)</p> <p>To cancel Alpha, press <b>ALPHA</b> again.</p> <p>For a lower case letter, press <b>SHIFT</b> <b>ALPHA</b> .</p> <p>For a string of letters, hold down <b>ALPHA</b> while typing.</p>

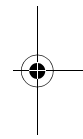
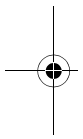

**HELPWITH**

The HP 40gs built-in help is available in HOME only. It provides syntax help for built-in math functions.

Access the HELPWITH command by pressing  $\text{[SHIFT]}$   $\text{[SYNTAX]}$  and then the math key for which you require syntax help.

**Example**

Press  $\text{[SHIFT]}$   $\text{[SYNTAX]}$

$\text{[X}^2\text{]} \text{[ENTER]}$



*Note: Remove the left parenthesis from built-in functions such as sine, cosine, and tangent before invoking the HELPWITH command.*

*Note: In the CAS system, pressing the  $\text{[SHIFT]}$   $\text{[SYNTAX]}$  will show the CAS help menu.*

**Math keys**

HOME ( $\text{[HOME]}$ ) is the place to do non-symbolic calculations. (For symbolic calculations, use the computer algebra system, referred throughout this manual as CAS).

**Keyboard keys.** The most common operations are available from the keyboard, such as the arithmetic (like  $\text{[+]}$ ) and trigonometric (like  $\text{[SIN]}$ ) functions. Press  $\text{[ENTER]}$  to complete the operation:  $\text{[SHIFT]}$   $\sqrt{\phantom{x}}$  256  $\text{[ENTER]}$  displays 16.

**MATH menu.** Press  $\text{[MATH]}$  to open the MATH menu. The MATH menu is a comprehensive list of math functions that do not appear on the keyboard. It also includes categories for all other functions and constants. The functions are grouped by category, ranging in alphabetical order from Calculus to Trigonometry.



- The arrow keys scroll through the list ( $\text{[↓]}$ ,  $\text{[↑]}$ ) and move from the category list in the left column to the item list in the right column ( $\text{[←]}$ ,  $\text{[→]}$ ).
- Press  $\text{[OK]}$  to insert the selected command onto the edit line.
- Press  $\text{[KANCL]}$  to dismiss the MATH menu without selecting a command.



- Pressing **CONS** displays the list of Program Constants. You can use these in programs that you develop.
- Pressing **PHYS** displays a menu of physical constants from the fields of chemistry, physics, and quantum mechanics. You can use these constants in calculations. (pSee "Physical constants" on page 13-25 for more information.)
- Pressing **MATH** takes you to the beginning of the MATH menu.

See "Math functions by category" on page 13-2 for details of the math functions.

**HINT**

When using the MATH menu, or any menu on the HP 40gs, pressing an alpha key takes you straight to the first menu option beginning with that alpha character. With this method, you do not need to press **ALPHA** first. Just press the key that corresponds to the command's beginning alpha character.

Note that when the MATH menu is open, you can also access CAS commands. You do this by pressing **CAS**. This enables you to use CAS commands on the HOME screen, without opening CAS. See Chapter 14 for details of CAS commands.

**Program commands**

Pressing **SHIFT** **CMDS** displays the list of Program Commands. See "Programming commands" on page 21-13.

**Inactive keys**

If you press a key that does not operate in the current context, a warning symbol like this **▲** appears. There is no beep.

**Menus**

A menu offers you a choice of items. Menus are displayed in one or two columns.



- The **▼** arrow in the display means more items below.
- The **▲** arrow in the display means more items above.





### To search a menu

- Press  $\downarrow$  or  $\uparrow$  to scroll through the list. If you press  $\text{SHIFT} \downarrow$  or  $\text{SHIFT} \uparrow$ , you'll go all the way to the end or the beginning of the list. Highlight the item you want to select, then press  $\text{MATH}$  (or  $\text{ENTER}$ ).
- If there are two columns, the left column shows general categories and the right column shows specific contents within a category. Highlight a general category in the left column, then highlight an item in the right column. The list in the right column changes when a different category is highlighted. Press  $\text{MATH}$  or  $\text{ENTER}$  when you have highlighted your selection.
- To speed-search a list, type the first letter of the word. For example, to find the Matrix category in  $\text{MATH}$ , press  $\text{M}$ , the Alpha "M" key.
- To go up a page, you can press  $\text{SHIFT} \leftarrow$ . To go down a page, press  $\text{SHIFT} \rightarrow$ .

### To cancel a menu

Press  $\text{ON}$  (for *CANCEL*) or  $\text{EXIT}$ . This cancels the current operation.

## Input forms

An input form shows several fields of information for you to examine and specify. After highlighting the field to edit, you can enter or edit a number (or expression). You can also select options from a list ( $\text{EDIT}$ ). Some input forms include items to check ( $\text{CHECK}$ ). See below for examples input forms.



### Reset input form values

To reset a field to its default values in an input form, move the cursor to that field and press  $\text{DEL}$ . To reset all default field values in the input form, press  $\text{SHIFT} \text{ CLEAR}$ .

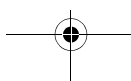



## Mode settings

You use the Modes input form to set the modes for HOME.

### HINT

Although the numeric setting in Modes affects only HOME, the angle setting controls HOME and the current aplet. The angle setting selected in Modes is the angle setting used in both HOME and current aplet. To further configure an aplet, you use the *SETUP* keys (**SHIFT** **PLOT** and **SHIFT** **NUM**).

Press **SHIFT** *MODES* to access the HOME MODES input form.

Setting	Options
Angle Measure	<p>Angle values are:</p> <p><b>Degrees.</b> 360 degrees in a circle.</p> <p><b>Radians.</b> <math>2\pi</math> radians in a circle.</p> <p><b>Grads.</b> 400 grads in a circle.</p> <p>The angle mode you set is the angle setting used in both HOME and the current aplet. This is done to ensure that trigonometric calculations done in the current aplet and HOME give the same result.</p>
Number Format	<p>The number format mode you set is the number format used in both HOME and the current aplet.</p> <p><b>Standard.</b> Full-precision display.</p> <p><b>Fixed.</b> Displays results rounded to a number of decimal places. Example: 123.456789 becomes 123.46 in Fixed 2 format.</p> <p><b>Scientific.</b> Displays results with an exponent, one digit to the left of the decimal point, and the specified number of decimal places. Example: 123.456789 becomes 1.23E2 in Scientific 2 format.</p>

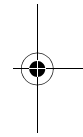
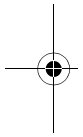



Setting	Options (Continued)
Decimal Mark	<p><b>Engineering.</b> Displays result with an exponent that is a multiple of 3, and the specified number of significant digits beyond the first one. Example: 123.456E7 becomes 1.23E9 in Engineering 2 format.</p> <p><b>Fraction.</b> Displays results as fractions based on the specified number of decimal places. Examples: 123.456789 becomes 123 in Fraction 2 format, and .333 becomes 1/3 and 0.142857 becomes 1/7. See "Using fractions" on page 1-25.</p> <p><b>Mixed Fraction.</b> Displays results as mixed fractions based on the specified number of decimal places. A mixed fraction has an integer part and a fractional part. Examples: 123.456789 becomes 123+16/35 in Fraction 2 format, and <math>7 \div 3</math> returns <math>2 + 1/3</math>. See "Using fractions" on page 1-25.</p> <p><b>Dot or Comma.</b> Displays a number as 12456.98 (Dot mode) or as 12456,98 (Comma mode). Dot mode uses commas to separate elements in lists and matrices, and to separate function arguments. Comma mode uses periods (dot) as separators in these contexts.</p>

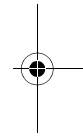
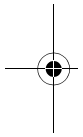

## Setting a mode

This example demonstrates how to change the angle measure from the default mode, radians, to degrees for the current aplet. The procedure is the same for changing number format and decimal mark modes.

1. Press **SHIFT** *MODES* to open the HOME MODES input form.

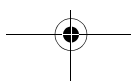

The cursor (highlight) is in the first field, Angle Measure.



2. Press **CHOOSE** to display a list of choices.



3. Press **▲** to select Degrees, and press **CHOOSE**. The angle measure changes to degrees.
4. Press **HOME** to return to HOME.



**HINT** Whenever an input form has a list of choices for a field, you can press **+** to cycle through them instead of using **CHOOSE**.

## Aplets (E-lessons)

Aplets are the application environments where you explore different classes of mathematical operations. You select the aplet that you want to work with.

Aplets come from a variety of sources:

- Built-in the HP 40gs (initial purchase).
- Aplets created by saving existing aplets, which have been modified, with specific configurations. See “Creating new aplets based on existing aplets” on page 22-1.
- Downloaded from HP’s Calculators web site.
- Copied from another calculator.

Aplets are stored in the Aplet library. See “Aplet library” on page 1-16 for further information.



You can modify configuration settings for the graphical, tabular, and





symbolic views of the applets in the following table. See “Applet view configuration” on page 1-18 for further information.

Applet name	Use this applet to explore:
Function	Real-valued, rectangular functions $y$ in terms of $x$ . Example: $y = 2x^2 + 3x + 5$ .
Inference	Confidence intervals and Hypothesis tests based on the Normal and Students-t distributions.
Parametric	Parametric relations $x$ and $y$ in terms of $t$ . Example: $x = \cos(t)$ and $y = \sin(t)$ .
Polar	Polar functions $r$ in terms of an angle $\theta$ . Example: $r = 2 \cos(4\theta)$ .
Sequence	Sequence functions $U$ in terms of $n$ , or in terms of previous terms in the same or another sequence, such as $U_{n-1}$ and $U_{n-2}$ . Example: $U_1 = 0$ , $U_2 = 1$ and $U_n = U_{n-2} + U_{n-1}$ .
Solve	Equations in one or more real-valued variables. Example: $x + 1 = x^2 - x - 2$ .
Finance	Time Value of Money (TVM) calculations.
Linear Solver	Solutions to sets of two or three linear equations.
Triangle Solver	Unknown values for the lengths and angles of triangles.
Statistics	One-variable ( $x$ ) or two-variable ( $x$ and $y$ ) statistical data.

In addition to these applets, which can be used in a variety of applications, the HP 40gs is supplied with two teaching applets: Quad Explorer and Trig Explorer. You cannot modify configuration settings for these applets.

A great many more teaching applets can be found at HP’s web site and other web sites created by educators, together with accompanying documentation, often with student work sheets. These can be downloaded free of

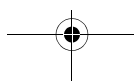



### Quad Explorer aplet

charge and transferred to the HP 40gs using the provided Connectivity Kit.

The **Quad Explorer** applet is used to investigate the behaviour of  $y = a(x+h)^2 + v$  as the values of  $a$ ,  $h$  and  $v$  change, both by manipulating the equation and seeing the change in the graph, and by manipulating the graph and seeing the change in the equation.

#### HINT

More detailed documentation, and an accompanying student work sheet can be found at HP's web site.

Press **[APLET]**, select Quad Explorer, and then press **[GRAPH]**. The Quad Explorer applet opens in **[EDIT]** mode, in which the arrow keys, the **[+]** and **[-]** keys, and the **[(-)]** key are used to change the shape of the graph. This changing shape is reflected in the equation displayed at the top right corner of the screen, while the original graph is retained for comparison. In this mode the graph controls the equation.

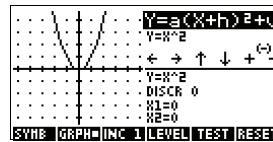

It is also possible to have the equation control the graph. Pressing **[EDIT]** displays a sub-expression of your equation.

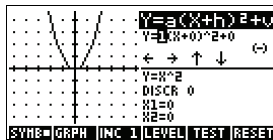

Pressing the **[▶]** and **[◀]** key moves between sub-expressions, while pressing the **[▲]** and **[▼]** key changes their values.

Pressing **[EDIT]** allows the user to select whether all three sub-expressions will be explored at once or only one at a time.

A **[TEST]** button is provided to evaluate the student's knowledge. Pressing **[TEST]** displays a target quadratic graph. The student must manipulate the equation's parameters to make the equation match the target graph. When a student feels that they have correctly chosen the parameters a **[CHECK]** button evaluates the answer and provide feedback. An **[EDIT]** button is provided for those who give up!

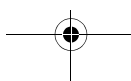

### Trig Explorer applet

The **Trig Explorer** applet is used to investigate the behaviour of the graph of  $y = a\sin(bx + c) + d$  as the values of  $a$ ,  $b$ ,  $c$  and  $d$  change, both by manipulating the equation and seeing the change in the graph, or by manipulating the graph and seeing the change in the equation.

Press **TRIG**, select Trig Explorer, and then press **GRAPH** to display the screen shown right.

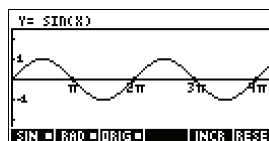

In this mode, the graph controls the equation. Pressing the **▲** **▼** and **◀** **▶** keys transforms the graph, with these transformations reflected in the equation.

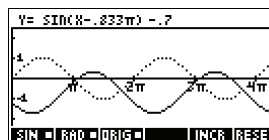

The button labelled **ORIG** is a toggle between **ORIG** and **EXTRE**. When **ORIG** is chosen, the 'point of control' is at the origin (0,0) and the **▲** **▼** and **◀** **▶** keys control vertical and horizontal transformations. When **EXTRE** is chosen the 'point of control' is on the first extremum of the graph (i.e. for the sine graph at  $(\pi/2, 1)$ ).

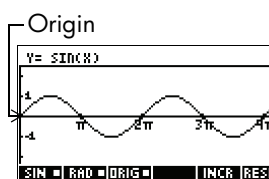

The arrow keys change the amplitude and frequency of the graph. This is most easily seen by experimenting.

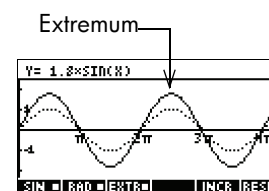

Pressing **SYMB** displays the equation at the top of the screen. The equation is controlled by the graph. Pressing the **▶** and **◀** keys moves from parameter to parameter. Pressing the **▲** or **▼** key changes the parameter's values.

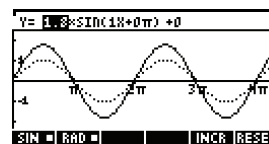

The default angle setting for this applet is radians. The angle setting can be changed to degrees by pressing **DEG**.



## Aplet library

Aplets are stored in the Aplet library.

### To open an aplet

Press **[APLET]** to display the Aplet library menu. Select the aplet and press **[EXIT]** or **[ENTER]**.

From within an aplet, you can return to HOME any time by pressing **[HOME]**.

## Aplet views

When you have configured an aplet to define the relation or data that you want to explore, you can display it in different views. Here are illustrations of the three major aplet views (Symbolic, Plot, and Numeric), the six supporting aplet views (from the VIEWS menu), and the two user-defined views (Note and Sketch).

*Note:* some aplets—such as the Linear Solver aplet and the Triangle Solver aplet—only have a single view, the Numeric view.

### Symbolic view

Press **[SYMB]** to display the aplet's Symbolic view.

You use this view to define the function(s) or equation(s) that you want to explore.

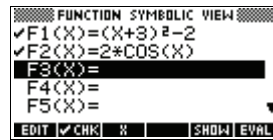

See "About the Symbolic view" on page 2-1 for further information.

### Plot view

Press **[PLOT]** to display the aplet's Plot view.

In this view, the functions that you have defined are displayed graphically.

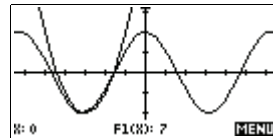

See "About the Plot view" on page 2-5 for further information.

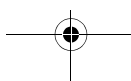



### Numeric view

Press **[NUM]** to display the aplet's Numeric view.

In this view, the functions that you have defined are displayed in tabular format.

X	F1	F2
0	2	2
1	7.51	1.490008
2	8.24	1.460133
3	8.89	1.410673
4	9.56	1.342122
5	10.25	1.255165

See "About the numeric view" on page 2-16 for further information.

### Plot-Table view

The VIEWS menu contains the Plot-Table view.

**[VIEWS]**

Select Plot-Table **[VIEW]**

Splits the screen into the plot and the data table. See "Other views for scaling and splitting the graph" on page 2-13 for further information.

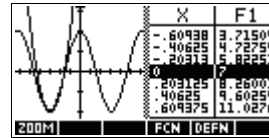

### Plot-Detail view

The VIEWS menu contains the Plot-Detail view.

**[VIEWS]**

Select Plot-Detail **[VIEW]**

Splits the screen into the plot and a close-up.

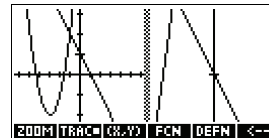

See "Other views for scaling and splitting the graph" on page 2-13 for further information.

### Overlay Plot view

The VIEWS menu contains the Overlay Plot view.

**[VIEWS]**

Select Overlay Plot **[VIEW]**

Plots the current expression(s) *without* erasing any pre-existing plot(s).

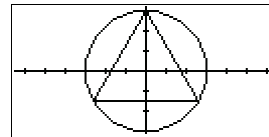

See "Other views for scaling and splitting the graph" on page 2-13 for further information.

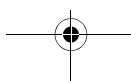
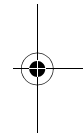
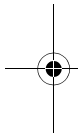



## Note view

Press **[SHIFT]** *NOTE* to display the aplet's note view.

This note is transferred with the aplet if it is sent to another calculator or to a PC. A note view contains text to supplement an aplet.



See "Notes and sketches" on page 20-1 for further information.

## Sketch view

Press **[SHIFT]** *SKETCH* to display the aplet's sketch view.

Displays pictures to supplement an aplet.

See "Notes and sketches" on page 20-1 for further information.

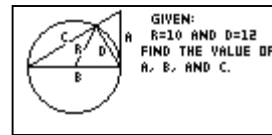

## Aplet view configuration

You use the *SETUP* keys (**[SHIFT]** **[PLOT]**, and **[SHIFT]** **[NUM]**) to configure the aplet. For example, press **[SHIFT]** *SETUP-PLOT* (**[SHIFT]** **[PLOT]**) to display the input form for setting the aplet's plot settings. Angle measure is controlled using the *MODES* view.

### Plot Setup

Press **[SHIFT]** *SETUP-PLOT*. Sets parameters to plot a graph.

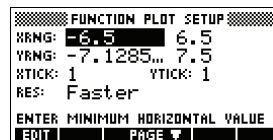

### Numeric Setup

Press **[SHIFT]** *SETUP-NUM*. Sets parameters for building a table of numeric values.

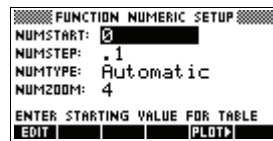

### Symbolic Setup

This view is only available in the Statistics aplet in **EDIT** mode, where it plays an important role in choosing data models.

Press **[SHIFT]** *SETUP-SYMB*.

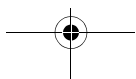
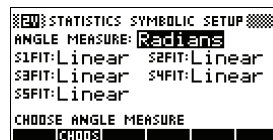



### To change views

Each view is a separate environment. To change a view, select a different view by pressing **[SYMB]**, **[NUM]**, **[PLOT]** keys or select a view from the VIEWS menu. To change to HOME, press **[HOME]**. You do not explicitly close the current view, you just enter another one—like passing from one room into another in a house. Data that you enter is automatically saved as you enter it.

### To save aplet configuration

You can save an aplet configuration that you have used, and transfer the aplet to other HP 40gs calculators. See “Creating new aplets based on existing aplets” on page 22-1.

## Mathematical calculations

The most commonly used math operations are available from the keyboard. Access to other math functions is via the MATH menu (**[MATH]**). You can also CAS for symbolic calculations. See “Computer Algebra System (CAS)” on page 14-1 for further information.

To access programming commands, press **[SHIFT]** *CMDS*. See “Programming commands” on page 21-13 for further information.

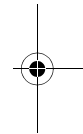
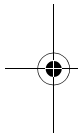

### Where to start

The home base for the calculator is the HOME view (**[HOME]**). You can do all non-symbolic calculations here, and you can access all **[MATH]** operations. (Symbolic calculations are done using CAS.)

### Entering expressions

- In the HOME view, you enter an expression in the same left-to-right order that you would write the expression. This is called *algebraic entry*. (In CAS you enter expressions using the Equation Writer, explained in detail in Chapter 15, “Equation Writer”.)
- To enter functions, select the key or MATH menu item for that function. You can also enter a function by using the Alpha keys to spell out its name.
- Press **[ENTER]** to evaluate the expression you have in the edit line (where the blinking cursor is). An *expression* can contain numbers, functions, and variables.

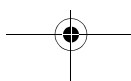

### Example

Calculate  $\frac{23^2 - 14\sqrt{8}}{-3} \ln(45)$  :

[ 23 ] [ X<sup>2</sup> ]  
 [ - ] 14  
 [ × ] [ SHIFT ] [ √ ] 8 [ ) ]  
 [ + ] [ ( - ) ] 3 [ × ]  
 [ ln ] 45 [ ) ]  
 [ ENTER ]

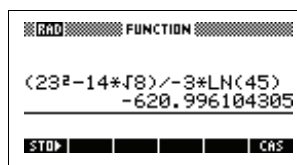

### Long results

If the result is too long to fit on the display line, or if you want to see an expression in textbook format, press  $\blacktriangle$  to highlight it and then press  $\text{FORMAT}$ .

### Negative numbers

Type  $(-)$  to start a negative number or to insert a negative sign.

To raise a negative number to a power, enclose it in parentheses. For example,  $(-5)^2 = 25$ , whereas  $-5^2 = -25$ .

### Scientific notation (powers of 10)

A number like  $5 \times 10^4$  or  $3.21 \times 10^{-7}$  is written in *scientific notation*, that is, in terms of powers of ten. This is simpler to work with than 50000 or 0.000000321. To enter numbers like these, use *EEX*. (This is easier than using  $\times 10$   $[X^2]$ .)

### Example

Calculate  $\frac{(4 \times 10^{-13})(6 \times 10^{23})}{3 \times 10^{-5}}$

[ 4 ] [ SHIFT ] [ EEX ]  
 [ ( - ) ] 13 [ ) ]  
 [ × ] [ 6 ] [ SHIFT ] [ EEX ]  
 23 [ ) ] [ ÷ ] 3 [ SHIFT ] [ EEX ]  
 [ ( - ) ] 5  
 [ ENTER ]

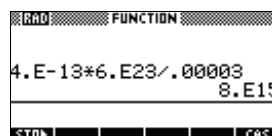

### Explicit and implicit multiplication

*Implied* multiplication takes place when two operands appear with no operator in between. If you enter AB, for example, the result is A\*B.





However, for clarity, it is better to include the multiplication sign where you expect multiplication in an expression. It is clearest to enter  $AB$  as  $A*B$ .

### HINT

Implied multiplication will not always work as expected. For example, entering  $A(B+4)$  will not give  $A*(B+4)$ . Instead an error message is displayed: "Invalid User Function". This is because the calculator interprets  $A(B+4)$  as meaning 'evaluate function  $A$  at the value  $B+4$ ', and function  $A$  does not exist. When in doubt, insert the  $*$  sign manually.

## Parentheses

You need to use parentheses to enclose arguments for functions, such as  $\text{SIN}(45)$ . You can omit the final parenthesis at the end of an edit line. The calculator inserts it automatically.

Parentheses are also important in specifying the order of operation. *Without parentheses*, the HP 40gs calculates according to the order of *algebraic precedence* (the next topic). Following are some examples using parentheses.

Entering...	Calculates...
$\boxed{\text{SIN}} \ 45 \boxed{+} \ \boxed{\text{SHIFT}} \ \pi$	$\sin(45 + \pi)$
$\boxed{\text{SIN}} \ 45 \boxed{)} \ \boxed{+} \ \boxed{\text{SHIFT}} \ \pi$	$\sin(45) + \pi$
$\boxed{\text{SHIFT}} \ \sqrt{\phantom{x}} \ 85 \boxed{\times} \ 9$	$\sqrt{85} \times 9$
$\boxed{\text{SHIFT}} \ \sqrt{\phantom{x}} \ \boxed{(} \ 85 \boxed{\times} \ 9 \boxed{)}$	$\sqrt{85 \times 9}$

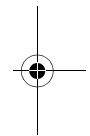
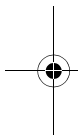

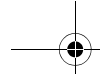

## Algebraic precedence order of evaluation

Functions within an expression are evaluated in the following order of precedence. Functions with the same precedence are evaluated in order from left to right.

1. Expressions within parentheses. Nested parentheses are evaluated from inner to outer.
2. Prefix functions, such as SIN and LOG.
3. Postfix functions, such as !
4. Power function, ^, NTHROOT.
5. Negation, multiplication, and division.
6. Addition and subtraction.
7. AND and NOT.
8. OR and XOR.
9. Left argument of | (where).
10. Equals, =.

## Largest and smallest numbers

The smallest number the HP 40gs can represent is  $1 \times 10^{-499}$  (1E-499). A smaller result is displayed as zero. The largest number is  $9.9999999999 \times 10^{499}$  (1E499). A greater result is displayed as this number.

## Clearing numbers

- **DEL** clears the character under the cursor. When the cursor is positioned after the last character, **DEL** deletes the character to the left of the cursor, that is, it performs the same as a backspace key.
- **CANCEL** (**ON**) clears the edit line.
- **SHIFT CLEAR** clears all input and output in the display, including the display history.

## Using previous results

The HOME display (**HOME**) shows you four lines of input/output history. An unlimited (except by memory) number of previous lines can be displayed by scrolling. You can retrieve and reuse any of these values or expressions.

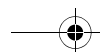

When you highlight a previous input or result (by pressing  $\uparrow$ ), the **COPY** and **SHOW** menu labels appear.



**To copy a previous line**

Highlight the line (press  $\uparrow$ ) and press **COPY**. The number (or expression) is copied into the edit line.

**To reuse the last result**

Press **SHIFT** *ANS* (last answer) to put the last result from the HOME display into an expression. *ANS* is a variable that is updated each time you press **ENTER**.

**To repeat a previous line**

To repeat the very last line, just press **ENTER**. Otherwise, highlight the line (press  $\uparrow$ ) first, and then press **ENTER**. The highlighted expression or number is re-entered. If the previous line is an expression containing the *ANS*, the calculation is repeated iteratively.

**Example**

See how **SHIFT** *ANS* retrieves and reuses the last result (50), and **ENTER** updates *ANS* (from 50 to 75 to 100).

50 **ENTER** **+** 25  
**ENTER** **ENTER**

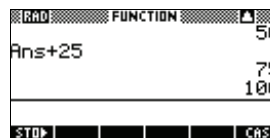

You can use the last result as the first expression in the edit line without pressing **SHIFT** *ANS*. Pressing **+**, **-**, **(-)**, or **÷**, (or other operators that require a preceding argument) automatically enters *ANS* before the operator.

You can reuse any other expression or value in the HOME display by highlighting the expression (using the arrow keys), then pressing **COPY**. See "Using previous results" on page 1-22 for more details.

The variable *ANS* is different from the numbers in HOME's display history. A value in *ANS* is stored internally with the full precision of the calculated result, whereas the displayed numbers match the display mode.

**HINT**

When you retrieve a number from *ANS*, you obtain the result to its full precision. When you retrieve a number from the HOME's display history, you obtain exactly what was displayed.

Pressing **ENTER** evaluates (or re-evaluates) the last input, whereas pressing **SHIFT** *ANS* copies the last result (as *ANS*) into the edit line.

**Storing a value in a variable**

You can save an answer in a variable and use the variable in later calculations. There are 27 variables available for storing real values. These are A to Z and  $\theta$ . See Chapter 17, "Variables and memory management" for more information on variables. For example:

1. Perform a calculation.

45 **+** 8 **X<sup>Y</sup>** 3  
**ENTER**

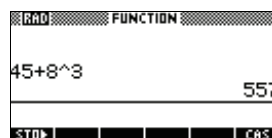

2. Store the result in the A variable.

**STO** **ALPHA** A  
**ENTER**

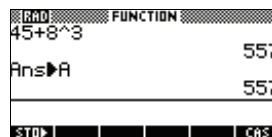

3. Perform another calculation using the A variable.

95 **+** 2 **x** **ALPHA** A  
**ENTER**

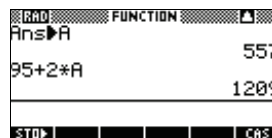



## Accessing the display history

Pressing enables the highlight bar in the display history. While the highlight bar is active, the following menu and keyboard keys are very useful:

Key	Function
,	Scrolls through the display history.
	Copies the highlighted expression to the position of the cursor in the edit line.
	Displays the current expression in standard mathematical form.
	Deletes the highlighted expression from the display history, unless there is a cursor in the edit line.
 <i>CLEAR</i>	Clears all lines of display history and the edit line.

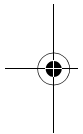

## Clearing the display history

It's a good habit to clear the display history ( *CLEAR*) whenever you have finished working in HOME. It saves calculator memory to clear the display history. Remember that *all* your previous inputs and results are saved until you clear them.

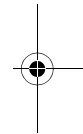

## Using fractions

To work with fractions in HOME, you set the number format to *Fraction* or *Mixed Fraction*, as follows:

### Setting Fraction mode

1. In HOME, open the HOME MODES input form.

*MODES*

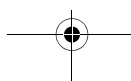

2. Select Number Format, press **CHOOSE** to display the options, and highlight Fraction or Mixed Fraction.



3. Press **EDIT** to select the Number Format option, then move to the precision value field.

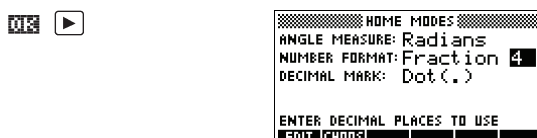

4. Enter the precision value that you want to use, and press **EDIT** to set the precision. Press **HOME** to return to HOME.

See "Setting fraction precision" below for more information.

## Setting fraction precision

The fraction precision setting determines the precision in which the HP 40g converts a decimal value to a fraction. The greater the precision value that is set, the closer the fraction is to the decimal value.

By choosing a precision of 1 you are saying that the fraction only has to match 0.234 to at least 1 decimal place ( $3/13$  is 0.23076...).

The fractions used are found using the technique of continued fractions.

When converting recurring decimals this can be important. For example, at precision 6 the decimal 0.6666 becomes  $3333/5000$  ( $6666/10000$ ) whereas at precision 3, 0.6666 becomes  $2/3$ , which is probably what you would want.

For example, when converting .234 to a fraction, the precision value has the following effect:

- Precision set to 1:



- Precision set to 2:



- Precision set to 3:



- Precision set to 4

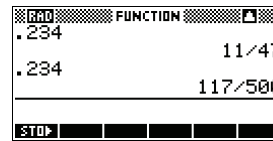

## Fraction calculations

When entering fractions:

- You use the  $\frac{\square}{\square}$  key to separate the numerator part and the denominator part of the fraction.
- To enter a mixed fraction, for example,  $1\frac{1}{2}$ , you enter it in the format  $(1+\frac{1}{2})$ .

For example, to perform the following calculation:

$$3(2\frac{3}{4} + 5\frac{7}{8})$$

1. Set the Number format mode to Fraction or Mixed Fraction and specify a precision value of 4. In this example, we'll select Fraction as our format.)

**SHIFT** MODES  $\nabla$

**ENTR** Select

Fraction

**ENTER**  $\blacktriangleright$  4 **MEM**





2. Enter the calculation.

3  $\times$  ( ( 2 + 3  
 $\div$  4 ) + ( 5 + 7  
 $\div$  8 ) )

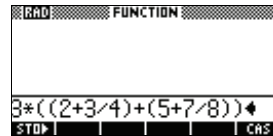

*Note: Ensure you are in the HOME view.*

3. Evaluate the calculation.

$\square$  ENTER

Note that if you had selected Mixed Fraction instead of Fraction as the Number format, the answer would have been expressed as  $25+7/8$ .

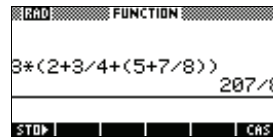

## Converting decimals to fractions

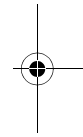
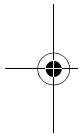

To convert a decimal value to a fraction:

1. Set the number format mode to Fraction or Mixed Fraction.
2. Either retrieve the value from the History, or enter the value on the command line.
3. Press  $\square$  ENTER to convert the number to a fraction.

When converting a decimal to a fraction, keep the following points in mind:

- When converting a recurring decimal to a fraction, set the fraction precision to about 6, and ensure that you include more than six decimal places in the recurring decimal that you enter.

In this example, the fraction precision is set to 6. The top calculation returns the correct result. The bottom one does not.

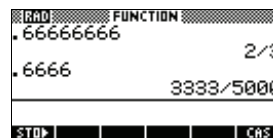

- To convert an exact decimal to a fraction, set the fraction precision to at least two more than the number of decimal places in the decimal.

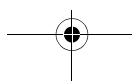



In this example, the fraction precision is set to 6.

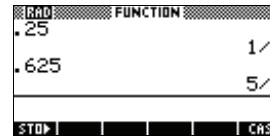

## Complex numbers

### Complex results

The HP 40gs can return a complex number as a result for some math functions. A complex number appears as an ordered pair  $(x, y)$ , where  $x$  is the real part and  $y$  is the imaginary part. For example, entering  $\sqrt{-1}$  returns  $(0, 1)$ .

### To enter complex numbers

Enter the number in either of these forms, where  $x$  is the real part,  $y$  is the imaginary part, and  $i$  is the imaginary constant,  $\sqrt{-1}$ :

- $(x, y)$  or
- $x + iy$ .

To enter  $i$ :

- press **SHIFT** **ALPHA** **I**
- or
- press **MATH**, **▲** or **▼** keys to select Constant, **▶** to move to the right column of the menu, **▼** to select  $i$ , and **□**.

### Storing complex numbers

There are 10 variables available for storing complex numbers: Z0 to Z9. To store a complex number in a variable:

- Enter the complex number, press **STO**, enter the variable to store the number in, and press **ENTER**.

**(4,5) STO**  
**ALPHA** Z 0 **ENTER**

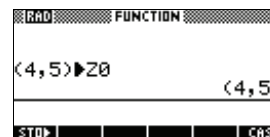

## Catalogs and editors

The HP 40gs has several catalogs and editors. You use them to create and manipulate objects. They access features and stored values (numbers or text or other items) that are independent of aplets.

- A *catalog* lists items, which you can delete or transmit, for example an aplet.
- An *editor* lets you create or modify items and numbers, for example a note or a matrix.

Catalog/Editor	Contents
Aplet library ( <b>[APLET]</b> )	Aplets.
Sketch editor ( <b>[SHIFT]</b> <i>SKETCH</i> )	Sketches and diagrams, See Chapter 20, "Notes and sketches".
List ( <b>[SHIFT]</b> <i>LIST</i> )	Lists. In HOME, lists are enclosed in {}. See Chapter 19, "Lists".
Matrix ( <b>[SHIFT]</b> <i>MATRIX</i> )	One- and two-dimensional arrays. In HOME, arrays are enclosed in []. See Chapter 18, "Matrices".
Notepad ( <b>[SHIFT]</b> <i>NOTEPAD</i> )	Notes (short text entries). See Chapter 20, "Notes and sketches".
Program ( <b>[SHIFT]</b> <i>PROGRM</i> )	Programs that you create, or associated with user-defined aplets. See Chapter 21, "Programming".
Equation Writer ( <b>[EQW]</b> )	The editor used for creating expressions and equations in CAS. See Chapter 15, "Equation Writer".



## 2

# Aplets and their views

---

## Aplet views

This section examines the options and functionality of the three main views for the Function, Polar, Parametric, and Sequence aplets: Symbolic, Plot, and Numeric views.

## About the Symbolic view

The Symbolic view is the *defining* view for the Function, Parametric, Polar, and Sequence aplets. The other views are derived from the symbolic expression.

You can create up to 10 different definitions for each Function, Parametric, Polar, and Sequence aplet. You can graph any of the relations (in the same aplet) simultaneously by selecting them.

## Defining an expression (Symbolic view)

Choose the aplet from the Aplet Library.

APLET

Press or to select an aplet.

START

APLET LIBRARY		LOG
Function	.05KB	▲
Inference	0KB	
Parametric	0KB	
Polar	0KB	
Sequence	0KB	▼
SAVE RESET SORT SEND RECV START		

The Function, Parametric, Polar, and Sequence aplets start in the Symbolic view.

If the highlight is on an existing expression, scroll to an empty line—unless you don't mind writing over the expression—or, clear one line ( ) or all lines ( *CLEAR*).

Expressions are selected (check marked) on entry. To deselect an expression, press . All selected expressions are plotted.

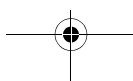



- **For a Function definition**, enter an expression to define  $F(X)$ . The only independent variable in the expression is  $X$ .

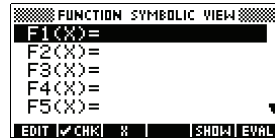

- **For a Parametric definition**, enter a pair of expressions to define  $X(T)$  and  $Y(T)$ . The only independent variable in the expressions is  $T$ .

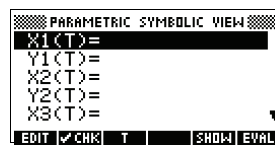

- **For a Polar definition**, enter an expression to define  $R(\theta)$ . The only independent variable in the expression is  $\theta$ .

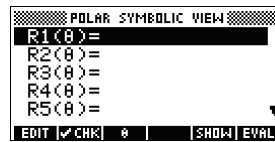

- **For a Sequence definition**, either enter the first term, or the first and second terms, for  $U$  ( $U1$ , or... $U9$ , or  $U0$ ). Then define the  $n$ th term of the sequence in terms of  $N$  or of the prior terms,  $U(N-1)$  and/or  $U(N-2)$ . The expressions should produce real-valued sequences with integer domains. Or define the  $n$ th term as a non-recursive expression in terms of  $n$  only. In this case, the calculator inserts the first two terms based on the expression that you define.

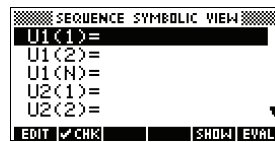

- *Note:* You will have to enter the second term if the hp40g is unable to calculate it automatically. Typically if  $U_x(N)$  depends on  $U_x(N-2)$  then you must enter  $U_x(2)$ .

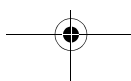
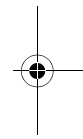
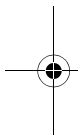

## Evaluating expressions

### In aplets

In the Symbolic view, a variable is a symbol only, and does not represent one specific value. To evaluate a function in Symbolic view, press **EQN**. If a function calls another function, then **EQN** resolves all references to other functions in terms of their independent variable.

1. Choose the Function aplet.

**APLET**  
Select Function  
**START**

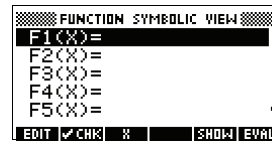

2. Enter the expressions in the Function aplet's Symbolic view.

**ALPHA** A **X** **EQN**  
**X<sup>2</sup>** **EQN**  
**ALPHA** B **EQN**  
**ALPHA** F1 **(** **EQN** **)**  
**+**  
**ALPHA** F2 **(** **EQN** **)** **EQN**

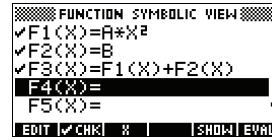

3. Highlight F3(X).

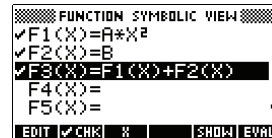

4. Press **EQN**

Note how the values for F1(X) and F2(X) are substituted into F3(X).

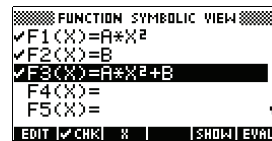

### In HOME

You can also evaluate any expression in HOME by entering it into the edit line and pressing **ENTER**.

For example, define F4 as below. In HOME, type F4(9) and press **ENTER**. This evaluates the expression, substituting 9 in place of X into F4.

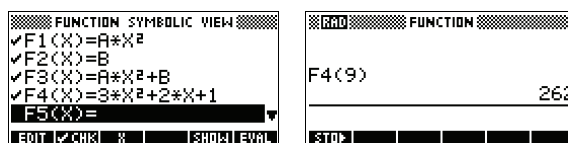

### SYMB view keys

The following table details the menu keys that you use to work with the Symbolic view.

Key	Meaning
<b>EDIT</b>	Copies the highlighted expression to the edit line for editing. Press <b>OK</b> when done.
<b>CHK</b>	Checks/unchecks the current expression (or set of expressions). Only checked expression(s) are evaluated in the Plot and Numeric views.
<b>X</b>	Enters the independent variable in the Function applet. Or, you can use the <b>X,T,θ</b> key on the keyboard.
<b>T</b>	Enters the independent variable in the Parametric applet. Or, you can use the <b>X,T,θ</b> key on the keyboard.
<b>θ</b>	Enters the independent variable in the Polar applet. Or, you can use the <b>X,T,θ</b> key on the keyboard.
<b>N</b>	Enters the independent variable in the Sequence applet. Or, you can use the <b>X,T,θ</b> key on the keyboard.
<b>SHOW</b>	Displays the current expression in text book form.
<b>EVAL</b>	Resolves all references to other definitions in terms of variables and evaluates all arithmetic expressions.
<b>VAR</b>	Displays a menu for entering variable names or contents of variables.

Key	Meaning (Continued)
<b>MATH</b>	Displays the menu for entering math operations.
<b>SHIFT</b> <i>CHARS</i>	Displays special characters. To enter one, place the cursor on it and press <b>OK</b> . To remain in the CHARS menu and enter another special character, press <b>EDIT</b> .
<b>DEL</b>	Deletes the highlighted expression or the current character in the edit line.
<b>SHIFT</b> <i>CLEAR</i>	Deletes all expressions in the list or clears the edit line.

## About the Plot view

After entering and selecting (check marking) the expression in the Symbolic view, press **PLOT**. To adjust the appearance of the graph or the interval that is displayed, you can change the Plot view settings.

You can plot up to ten expressions at the same time. Select the expressions you want to be plotted together.

## Setting up the plot (Plot view setup)

Press **SHIFT** *SETUP-PLOT* to define any of the settings shown in the next two tables.

- Highlight the field to edit.
  - If there is a number to enter, type it in and press **ENTER** or **OK**.
  - If there is an option to choose, press **CHOOSE**, highlight your choice, and press **ENTER** or **OK**. As a shortcut to **CHOOSE**, just highlight the field to change and press **+** to cycle through the options.
  - If there is an option to select or deselect, press **CHK** to check or uncheck it.
- Press **PAGE** to view more settings.
- When done, press **PLOT** to view the new plot.



## Plot view settings

The plot view settings are:

Field	Meaning
XRNG, YRNG	Specifies the minimum and maximum horizontal (X) and vertical (Y) values for the plotting window.
RES	For function plots: Resolution; "Faster" plots in alternate pixel columns; "Detail" plots in every pixel column.
TRNG	Parametric aplet: Specifies the t-values (T) for the graph.
θRNG	Polar aplet: Specifies the angle (θ) value range for the graph.
NRNG	Sequence aplet: Specifies the index (N) values for the graph.
TSTEP	For Parametric plots: the increment for the independent variable.
θSTEP	For Polar plots: the increment value for the independent variable.
SEQPLOT	For Sequence aplet: Stairstep or Cobweb types.
XTICK	Horizontal spacing for tickmarks.
YTICK	Vertical spacing for tickmarks.

Those items with space for a checkmark are settings you can turn on or off. Press **2nd** **ENTER** to display the second page.

Field	Meaning
SIMULT	If more than one relation is being plotted, plots them simultaneously (otherwise sequentially).
INV. CROSS	Cursor crosshairs invert the status of the pixels they cover.

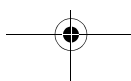





Field	Meaning (Continued)
CONNECT	Connect the plotted points. (The Sequence aplet always connects them.)
LABELS	Label the axes with XRNG and YRNG values.
AXES	Draw the axes.
GRID	Draw grid points using XTICK and YTICK spacing.

### Reset plot settings

To reset the default values for all plot settings, press **SHIFT** *CLEAR* in the Plot Setup view. To reset the default value for a field, highlight the field, and press **DEL**.

### Exploring the graph

Plot view gives you a selection of keys and menu keys to explore a graph further. The options vary from aplet to aplet.

### PLOT view keys

The following table details the keys that you use to work with the graph.

Key	Meaning
<b>SHIFT</b> <i>CLEAR</i>	Erases the plot and axes.
<b>VIEWS</b>	Offers additional pre-defined views for splitting the screen and for scaling ("zooming") the axes.
<b>SHIFT</b>	Moves cursor to far left or far right.
<b>SHIFT</b>	
	Moves cursor between relations.
<b>PRUSE</b> or <b>ON</b>	Interrupts plotting.
<b>CONT</b>	Continues plotting if interrupted.

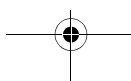

Key	Meaning (Continued)
<b>MENU</b>	Turns menu-key labels on and off. When the labels are off, pressing <b>MENU</b> turns them back on. <ul style="list-style-type: none"> <li>Pressing <b>MENU</b> once displays the full row of labels.</li> <li>Pressing <b>MENU</b> a second time removes the row of labels to display only the graph.</li> <li>Pressing <b>MENU</b> a third time displays the coordinate mode.</li> </ul>
<b>ZOOM</b>	Displays the ZOOM menu list.
<b>TRACE</b>	Turns trace mode on/off. A white box appears over the <b>□</b> on <b>TRACE</b> .
<b>GOTO</b>	Opens an input form for you to enter an $X$ (or $T$ or $N$ or $\theta$ ) value. Enter the value and press <b>OK</b> . The cursor jumps to the point on the graph that you entered.
<b>FCN</b>	Function aplet only: turns on menu list for root-finding functions (see "Analyse graph with FCN functions" on page 3-4).
<b>DEFN</b>	Displays the current, <i>defining</i> expression. Press <b>MENU</b> to restore the menu.

## Trace a graph

You can trace along a function using the **◀** or **▶** key which moves the cursor along the graph. The display also shows the current coordinate position ( $x$ ,  $y$ ) of the cursor. Trace mode and the coordinate display are automatically set when a plot is drawn.

*Note: Tracing might not appear to exactly follow your plot if the resolution (in Plot Setup view) is set to Faster. This is because RES: FASTER plots in only every other column, whereas tracing always uses every column.*

**In Function and Sequence Aplets:** You can also scroll (move the cursor) left or right beyond the edge of the display window in trace mode, giving you a view of more of the plot.

## To move between relations

If there is more than one relation displayed, press **▲** or **▼** to move between relations.



### To jump directly to a value

To jump straight to a value rather than using the Trace function, use the **GOTO** menu key. Press **GOTO**, then enter a value. Press **OK** to jump to the value.

### To turn trace on/off

If the menu labels are not displayed, press **MENU** first.

- Turn off trace mode by pressing **TRACE**.
- Turn on trace mode by pressing **TRACE**.
- To turn the coordinate display off, press **MENU**.

### Zoom within a graph

One of the menu key options is **ZOOM**. Zooming redraws the plot on a larger or smaller scale. It is a shortcut for changing the Plot Setup.

The **Set Factors...** option enables you to set the factors by which you zoom in or zoom out, and whether the zoom is centered about the cursor.

### ZOOM options

Press **ZOOM**, select an option, and press **OK**. (If **ZOOM** is not displayed, press **MENU**.) Not all **ZOOM** options are available in all aplets.

Option	Meaning
Center	Re-centers the plot around the current position of the cursor <i>without</i> changing the scale.
Box...	Lets you draw a box to zoom in on. See "Other views for scaling and splitting the graph" on page 2-13.
In	Divides horizontal and vertical scales by the X-factor and Y-factor. For instance, if zoom factors are 4, then zooming in results in 1/4 as many units depicted per pixel. (see <b>Set Factors...</b> )
Out	Multiplies horizontal and vertical scales by the X-factor and Y-factor (see <b>Set Factors...</b> ).
X-Zoom In	Divides horizontal scale only, using X-factor.
X-Zoom Out	Multiplies horizontal scale, using X-factor.

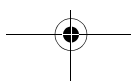
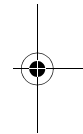
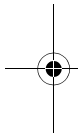



Option	Meaning (Continued)
Y-Zoom In	Divides vertical scale only, using Y-factor.
Y-Zoom Out	Multiplies vertical scale only, using Y-factor.
Square	Changes the vertical scale to match the horizontal scale. (Use this after doing a Box Zoom, X-Zoom, or Y-Zoom.)
Set Factors...	Sets the X-Zoom and Y-Zoom factors for zooming in or zooming out. Includes option to recenter the plot before zooming.
Auto Scale	Rescales the vertical axis so that the display shows a representative piece of the plot, for the supplied x axis settings. (For Sequence and Statistics aplets, autoscaling rescales both axes.)  The autoscale process uses the first selected function only to determine the best scale to use.
Decimal	Rescales both axes so each pixel = 0.1 units. Resets default values for X RNG (-6.5 to 6.5) and Y RNG (-3.1 to 3.2). (Not in Sequence or Statistics aplets.)
Integer	Rescales horizontal axis only, making each pixel = 1 unit. (Not available in Sequence or Statistics aplets.)
Trig	Rescales horizontal axis so 1 pixel = $\pi/24$ radians, 7.58, or $8\frac{1}{3}$ grads; rescales vertical axis so 1 pixel = 0.1 unit. (Not in Sequence or Statistics aplets.)

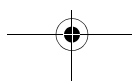
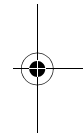
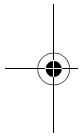



Option	Meaning (Continued)
Un-zoom	Returns the display to the previous zoom, or if there has been only one zoom, un-zoom displays the graph with the original plot settings.

### ZOOM examples

The following screens show the effects of zooming options on a plot of  $3 \sin x$ .

Plot of  $3 \sin x$

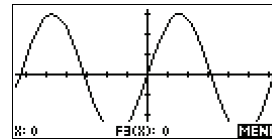

#### Zoom In:

`MENU ZOOM In OK`

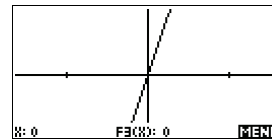

#### Un-zoom:

`ZOOM Un-zoom OK`

Note: Press  $\blacktriangle$  to move to the bottom of the Zoom list.

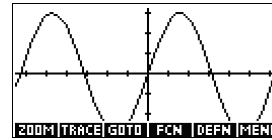

#### Zoom Out:

`ZOOM Out OK`

Now un-zoom.



#### X-Zoom In:

`ZOOM X-Zoom In OK`

Now un-zoom.

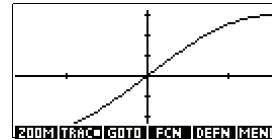

#### X-Zoom Out:

`ZOOM X-Zoom Out OK`

Now un-zoom.

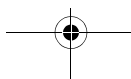
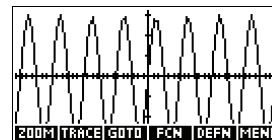



### Y-Zoom In:

**200M** Y-Zoom In **OK**

Now un-zoom.

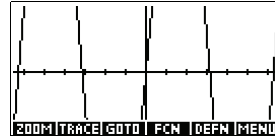

### Y-Zoom Out:

**200M** Y-Zoom Out **OK**

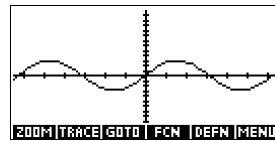

### Zoom Square:

**200M** Square **OK**

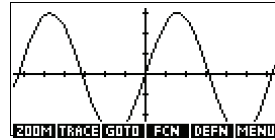

## To box zoom

The Box Zoom option lets you draw a box around the area you want to zoom in on by selecting the endpoints of one diagonal of the zoom rectangle.

1. If necessary, press **MENU** to turn on the menu-key labels.
2. Press **200M** and select Box . . .
3. Position the cursor on one corner of the rectangle. Press **OK**.
4. Use the cursor keys (**▼**, etc.) to drag to the opposite corner.
5. Press **OK** to zoom in on the boxed area.

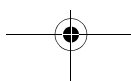
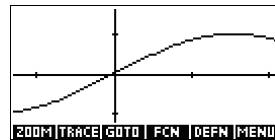
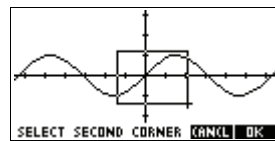



### To set zoom factors

1. In the Plot view, press **MENU**.
2. Press **ZOOM**.
3. Select Set Factors... and press **OK**.
4. Enter the zoom factors. There is one zoom factor for the horizontal scale (XZOOM) and one for the vertical scale (YZOOM).

Zooming out *multiplies* the scale by the factor, so that a greater scale distance appears on the screen.  
 Zooming in *divides* the scale by the factor, so that a shorter scale distance appears on the screen.

## Other views for scaling and splitting the graph

The preset viewing options menu (**VIEWS**) contains options for drawing the plot using certain pre-defined configurations. This is a shortcut for changing Plot view settings. For instance, if you have defined a trigonometric function, then you could select Trig to plot your function on a trigonometric scale. It also contains split-screen options.

In certain applets, for example those that you download from the world wide web, the preset viewing options menu can also contain options that relate to the applet.

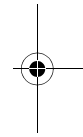
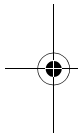

### VIEWS menu options

Press **VIEWS**, select an option, and press **OK**.

Option	Meaning
Plot-Detail	Splits the screen into the plot and a close-up.
Plot-Table	Splits the screen into the plot and the data table.
Overlay Plot	Plots the current expression(s) <i>without</i> erasing any pre-existing plot(s).

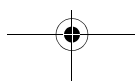



Option	Meaning (Continued)
Auto Scale	Rescales the vertical axis so that the display shows a representative piece of the plot, for the supplied x axis settings. (For Sequence and Statistics aplets, autoscaling rescales both axes.)  The autoscale process uses the first selected function only to determine the best scale to use.
Decimal	Rescales both axes so each pixel = 0.1 unit. Resets default values for XRNG (-6.5 to 6.5) and YRNG (-3.1 to 3.2). (Not in Sequence or Statistics aplets.)
Integer	Rescales horizontal axis only, making each pixel=1 unit. (Not available in Sequence or Statistics aplets.)
Trig	Rescales horizontal axis so 1 pixel= $\pi/24$ radian, 7.58, or $8^{1/3}$ grads; rescales vertical axis so 1 pixel = 0.1 unit. (Not in Sequence or Statistics aplets.)

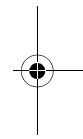
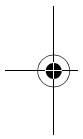

### Split the screen

The Plot-Detail view can give you two simultaneous views of the plot.

1. Press **VIEW**. Select Plot-Detail and press **OK**. The graph is plotted twice. You can now zoom in on the right side.

2. Press **MENU ZOOM**, select the zoom method and press **OK** or **ENTER**. This zooms the right side. Here is an example of split screen with Zoom In.

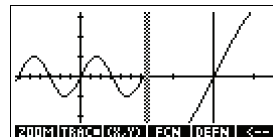

- The Plot menu keys are available as for the full plot (for tracing, coordinate display, equation display, and so on).

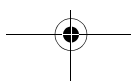





- **[SHIFT]** **[◀]** moves the leftmost cursor to the screen's left edge and **[SHIFT]** **[▶]** moves the rightmost cursor to the screen's right edge.
- The **[←=]** menu key copies the right plot to the left plot.

3. To un-split the screen, press **[PLOT]**. The left side takes over the whole screen.

The Plot-Table view gives you two simultaneous views of the plot.

1. Press **[VIEWS]**. Select Plot-Table and press **[0]**. The screen displays the plot on the left side and a table of numbers on the right side.

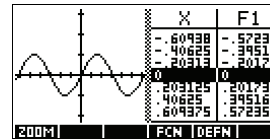

2. To move up and down the table, use the **[◀]** and **[▶]** cursor keys. These keys move the trace point left or right along the plot, and in the table, the corresponding values are highlighted.
3. To move between functions, use the **[PLOT]** and **[▼]** cursor keys to move the cursor from one graph to another.
4. To return to a full Numeric (or Plot) view, press **[NUM]** (or **[PLOT]**).

### Overlay plots

If you want to plot over an existing plot *without erasing* that plot, then use **[VIEWS]** Overlay Plot instead of **[PLOT]**. Note that tracing follows only the current functions from the current aplet.

### Decimal scaling

Decimal scaling is the default scaling. If you have changed the scaling to Trig or Integer, you can change it back with Decimal.

### Integer scaling

Integer scaling compresses the axes so that each pixel is  $1 \times 1$  and the origin is near the screen center.

### Trigonometric scaling

Use trigonometric scaling whenever you are plotting an expression that includes trigonometric functions. Trigonometric plots are more likely to intersect the axis at points factored by  $\pi$ .

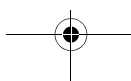

## About the numeric view

After entering and selecting (check marking) the expression or expressions that you want to explore in the Symbolic view, press **NUM** to view a table of data values for the independent variable ( $X$ ,  $T$ ,  $\theta$ , or  $N$ ) and dependent variables.

X	F1	F2
0	1	2
.1	.4	7.61
.2	.8	8.24
.3	.7	8.84
.4	.6	9.56
.5	.5	10.25

## Setting up the table (Numeric view setup)

Press **SHIFT NUM** to define any of the table settings. Use the Numeric Setup input form to configure the table.

FUNCTION NUMERIC SETUP	
NUMSTART:	0
NUMSTEP:	.1
NUMTYPE:	Automatic
NUMZOOM:	4
ENTER STARTING VALUE FOR TABLE	
EDIT	PLT

- Highlight the field to edit. Use the arrow keys to move from field to field.
  - If there is a number to enter, type it in and press **ENTER** or **MS**. To modify an existing number, press **EDIT**.
  - If there is an option to choose, press **CHOOSE**, highlight your choice, and press **ENTER** or **MS**.
  - Shortcut:** Press the **PLT** key to copy values from the Plot Setup into NUMSTART and NUMSTEP. Effectively, the **PLT** menu key allows you to make the table match the pixel columns in the graph view.
- When done, press **NUM** to view the table of numbers.

## Numeric view settings

The following table details the fields on the Numeric Setup input form.

Field	Meaning
NUMSTART	The independent variable's starting value.
NUMSTEP	The size of the increment from one independent variable value to the next.



Field	Meaning (Continued)
NUMTYPE	Type of numeric table: Automatic or Build Your Own. To build your own table, you must type each independent value into the table yourself.
NUMZOOM	Allows you to zoom in or out on a selected value of the independent variable.

### Reset numeric settings

To reset the default values for all table settings, press

**SHIFT** *CLEAR*.

## Exploring the table of numbers

### NUM view menu keys

The following table details the menu keys that you use to work with the table of numbers.

Key	Meaning
<b>ZOOM</b>	Displays ZOOM menu list.
<b>BIG</b>	Toggles between two character sizes.
<b>DEFN</b>	Displays the <i>defining</i> function expression for the highlighted column. To cancel this display, press <b>DEF</b> .

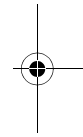
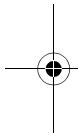



## Zoom within a table

Zooming redraws the table of numbers in greater or lesser detail.

### ZOOM options

The following table lists the zoom options:

Option	Meaning
In	Decreases the intervals for the independent variable so a narrower range is shown. Uses the NUMZOOM factor in Numeric Setup.
Out	Increases the intervals for the independent variable so that a wider range is shown. Uses the NUMZOOM factor in Numeric Setup.
Decimal	Changes intervals for the independent variable to 0.1 units. Starts at zero. (Shortcut to changing NUMSTART and NUMSTEP.)
Integer	Changes intervals for the independent variable to 1 unit. Starts at zero. (Shortcut to changing NUMSTEP.)
Trig	Changes intervals for independent variable to $\pi/24$ radian or 7.5 degrees or $8^{1/3}$ grads. Starts at zero.
Un-zoom	Returns the display to the previous zoom.

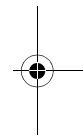
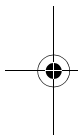

The display on the right is a Zoom In of the display on the left. The ZOOM factor is 4.

X	F1		
.075	.0248222		
.1	.0496444		
.125	.0744666		
.15	.1044888		
.175	.1345111		
.2	.1645333		
9.98334166468E-2			
ZOOM		BIG	DEFN

X	F1		
0	.0000000		
.1	.0496444		
.2	.1985778		
.3	.3475112		
.4	.4964446		
.5	.6453780		
9.98334166468E-2			
ZOOM		BIG	DEFN

### HINT

To jump to an independent variable value in the table, use the arrow keys to place the cursor in the independent variable column, then enter the value to jump to.





### Automatic recalculation

You can enter any new value in the *X* column. When you press **ENTER**, the values for the dependent variables are recalculated, and the entire table is regenerated with the same interval between *X* values.

## Building your own table of numbers

The default **NUMTYPE** is "Automatic", which fills the table with data for regular intervals of the independent (*X*, *T*,  $\theta$ , or *N*) variable. With the **NUMTYPE** option set to "Build Your Own", you fill the table yourself by typing in the independent-variable values you want. The dependent values are then calculated and displayed.

### Build a table

1. Start with an expression defined (in Symbolic view) in the aplet of your choice. *Note: Function, Polar, Parametric, and Sequence aplets only.*
2. In the Numeric Setup (**SHIFT****NUM**), choose **NUMTYPE: Build Your Own**.
3. Open the Numeric view (**NUM**).
4. Clear existing data in the table (**SHIFT****CLEAR**).
5. Enter the independent values in the left-hand column. Type in a number and press **ENTER**. You do not have to enter them in order, because the **SORT** function can rearrange them. To insert a number between two others, use **INS**.

You enter numbers into the *X* column →

<i>X</i>	F1	F2
-2	3	-1
2	-2.7	42.88
3.00	-5.9	1080.7
5	-5	79

← F1 and F2 entries are generated automatically

EDIT INS SORT BIG DEFN

### Clear data

Press **SHIFT****CLEAR**, **WE** to erase the data from a table.





## “Build Your Own” menu keys

Key	Meaning
<b>EDIT</b>	Puts the highlighted independent value ( $X$ , $T$ , $\theta$ , or $N$ ) into the edit line. Pressing <b>ENTER</b> replaces this variable with its current value.
<b>INS</b>	Inserts a zero value at the position of the highlight. Replace a zero by typing the number you want and pressing <b>ENTER</b> .
<b>SORT</b>	Sorts the independent variable values into ascending or descending order. Press <b>SORT</b> and select the ascending or descending option from the menu, and press <b>OK</b> .
<b>BIG</b>	Toggles between two character sizes.
<b>DEFN</b>	Displays the defining function expression for the highlighted column.
<b>DEL</b>	Deletes the highlighted row.
<b>SHIFT</b> CLEAR	Clears <i>all</i> data from the table.

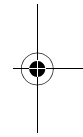
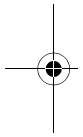

### Example: plotting a circle

Plot the circle,  $x^2 + y^2 = 9$ . First rearrange it to read

$$y = \pm\sqrt{9 - x^2}.$$

To plot both the positive and negative  $y$  values, you need to define two equations as follows:

$$y = \sqrt{9 - x^2} \text{ and } y = -\sqrt{9 - x^2}$$

1. In the Function applet, specify the functions.

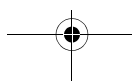

*Select*  
 Function   
   9  
     
  
    9

```

FUNCTION SYMBOLIC VIEW
✓F1(X)=√(9-X²)
✓F2(X)=-√(9-X²)
F3(X)=
F4(X)=
F5(X)=
EDIT ✓CHK 8 SHOW EVAL
    
```

2. Reset the graph setup to the default settings.

*SETUP-PLOT*  
 *CLEAR*

```

FUNCTION PLOT SETUP
XRNG: -6.5 6.5
YRNG: -3.1 3.2
XTICK: 1 YTICK: 1
RES: Detail
ENTER MINIMUM HORIZONTAL VALUE
EDIT PAGE ▾
    
```

3. Plot the two functions and hide the menu so that you can see all the circle.

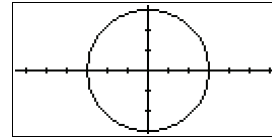

4. Reset the numeric setup to the default settings.

*SETUP-NUM*  
 *CLEAR*

```

FUNCTION NUMERIC SETUP
NUMSTART: 0
NUMSTEP: .1
NUMTYPE: Automatic
NUMZOOM: 4
ENTER STARTING VALUE FOR TABLE
EDIT PLOT▶
    
```

5. Display the functions in numeric form.

X	F1	F2
0	3.00000	3.00000
.1	2.99333	2.99333
.2	2.96667	2.96667
.3	2.92000	2.92000
.4	2.85333	2.85333
.5	2.75667	2.75667
0		
ZOOM  BIG DEFN		

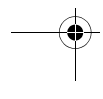
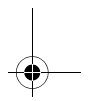
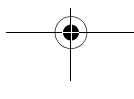
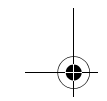
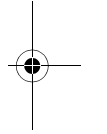
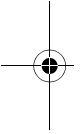
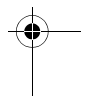
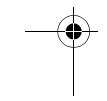
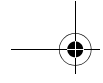





# 3

## Function applet

---

### About the Function applet

The Function applet enables you to explore up to 10 real-valued, rectangular functions  $y$  in terms of  $x$ . For example  $y = 2x + 3$ .

Once you have defined a function you can:

- create graphs to find roots, intercepts, slope, signed area, and extrema
- create tables to evaluate functions at particular values.

This chapter demonstrates the basic tools of the Function applet by stepping you through an example. See "Applet views" on page 2-1 for further information about the functionality of the Symbolic, Numeric, and Plot views.

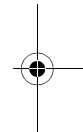
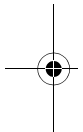

### Getting started with the Function applet

The following example involves two functions: a linear function  $y = 1 - x$  and a quadratic equation  $y = (x + 3)^2 - 2$ .

#### Open the Function applet

1. Open the Function applet.

[APLET] Select Function



The Function applet starts in the Symbolic view.

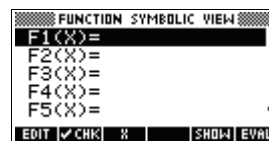

The Symbolic view is the *defining view* for Function, Parametric, Polar, and Sequence applets. The other views are derived from the symbolic expression.

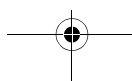

## Define the expressions

- There are 10 function definition fields on the Function aplet's Symbolic view screen. They are labeled F1(X) to F0(X). Highlight the function definition field you want to use, and enter an expression. (You can press **DEL** to delete an existing line, or **SHIFT** CLEAR to clear all lines.)

1 **[ ]** **[X,T,θ]** **[ENTER]**  
**[ ( ]** **[X,T,θ]** **[+]** **[3]** **[ ) ]** **[X<sup>2</sup>]**  
**[ - ]** **[2]** **[ENTER]**

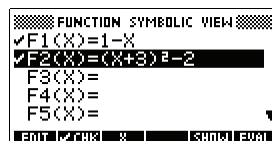

## Set up the plot

You can change the scales of the x and y axes, graph resolution, and the spacing of the axis ticks.

- Display plot settings.

**SHIFT** **SETUP-PLOT**



*Note: For our example, you can leave the plot settings at their default values since we will be using the Auto Scale feature to choose an appropriate y axis for our x axis settings. If your settings do not match this example, press **SHIFT** CLEAR to restore the default values.*

- Specify a grid for the graph.

**GRID**  
**[▶]** **[▼]** **[▼]** **[GRID]**

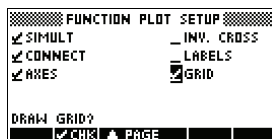

## Plot the functions

- Plot the functions.

**PLOT**

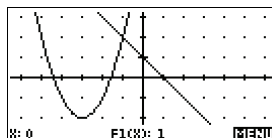



## Change the scale

- You can change the scale to see more or less of your graphs. In this example, choose *Auto Scale*. (See "VIEWS menu options" on page 2-13 for a description of Auto Scale).

**VIEWS** *Select Auto*  
 Scale

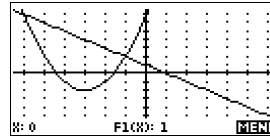
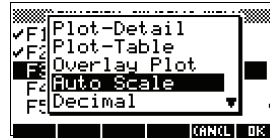

## Trace a graph

- Trace the linear function.

6 times

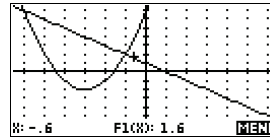

*Note: By default, the tracer is active.*

- Jump from the linear function to the quadratic function.

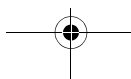
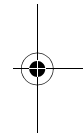
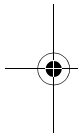
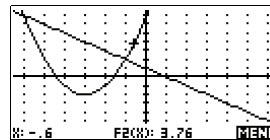



## Analyse graph with FCN functions

9. Display the Plot view menu.

**MENU**

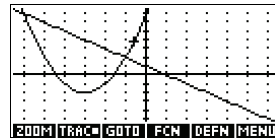

From the Plot view menu, you can use the functions on the FCN menu to find roots, intersections, slopes, and areas for a function defined in the Function aplet (and any Function-based aplets). The FCN functions act on the currently selected graph. See "FCN functions" on page 3-10 for further information.

## To find a root of the quadratic function

10. Move the cursor to the graph of the quadratic equation by pressing the **▲** or **▼** key. Then move the cursor so that it is near  $x = -1$  by pressing the **▶** or **◀** key.

**FCN** SelectRoot

**OK**



The root value is displayed at the bottom of the screen.

*Note: If there is more than one root (as in our example), the coordinates of the root closest to the current cursor position are displayed.*

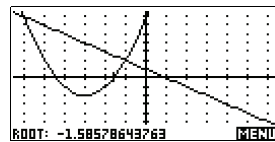

## To find the intersection of the two functions

11. Find the intersection of the two functions.

**MENU** **FCN** **▼** **OK**

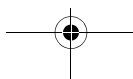



12. Choose the linear function whose intersection with the quadratic function you wish to find.

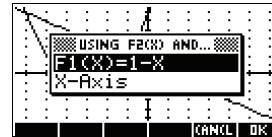

The coordinates of the intersection point are displayed at the bottom of the screen.

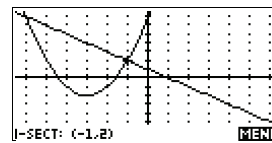

*Note: If there is more than one intersection (as in our example), the coordinates of the intersection point closest to the current cursor position are displayed.*

**To find the slope of the quadratic function**

13. Find the slope of the quadratic function at the intersection point.



Select Slope



The slope value is displayed at the bottom of the screen.

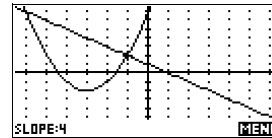

**To find the signed area of the two functions**

14. To find the area between the two functions in the range  $-2 \leq x \leq -1$ , first move the cursor to  $F1(x) = 1 - x$  and select the signed area option.



Select Signed area

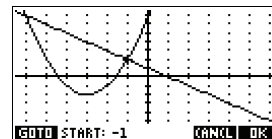

15. Move the cursor to  $x = -2$  by pressing the or key.

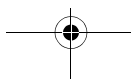



**OK**

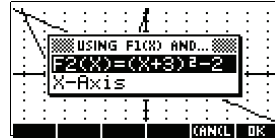

16. Press **OK** to accept using  $F2(x) = (x + 3)^2 - 2$  as the other boundary for the integral.

17. Choose the end value for x.

**GOTO**

**(-) 1**

**OK**



The cursor jumps to  $x = -1$  on the linear function.

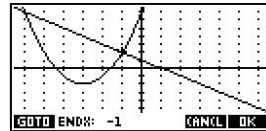

18. Display the numerical value of the integral.

**OK**

*Note: See "Shading area" on page 3-11 for another method of calculating area.*

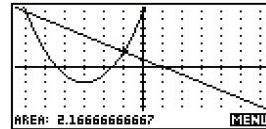

**To find the extremum of the quadratic**

19. Move the cursor to the quadratic equation and find the extremum of the quadratic.

**▲ MENU F5N**

Select Extremum **OK**

The coordinates of the extremum are displayed at the bottom of the screen.

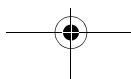
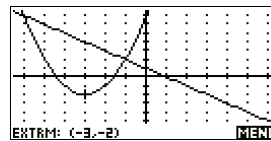

**HINT**

The Root and Extremum functions return one value only even if the function has more than one root or extremum. The function finds the value closest to the position of the cursor. You need to re-locate the cursor to find other roots or extrema that may exist.

**Display the numeric view**

20. Display the numeric view.

**NUM**

X	F1	F2	
0	1	?	
.1	.9	7.61	
.2	.8	8.24	
.4	.6	8.89	
.5	.5	10.25	
0			
ZOOM			
BIG DEFN			

**Set up the table**

21. Display the numeric setup.

**SHIFT SETUP-NUM**

FUNCTION NUMERIC SETUP	
NUMSTART:	0
NUMSTEP:	.1
NUMTYPE:	Automatic
NUMZOOM:	4
ENTER STARTING VALUE FOR TABLE	
EDIT	PLT

See "Setting up the table (Numeric view setup)" on page 2-16 for more information.

22. Match the table settings to the pixel columns in the graph view.

**ZOOM 03**

FUNCTION NUMERIC SETUP	
NUMSTART:	-6.5
NUMSTEP:	.1
NUMTYPE:	Automatic
NUMZOOM:	4
ENTER STARTING VALUE FOR TABLE	
EDIT	PLT

**Explore the table**

23. Display the table of values.

**NUM**

X	F1	F2	
-6.5	7.5	10.25	
-6.4	7.4	9.56	
-6.3	7.3	8.89	
-6.2	7.2	8.24	
-6.1	7.1	7.61	
-6	7	7	
-6.5			
ZOOM			
BIG DEFN			

**To navigate around a table**

24. Move to X = -5.9.

▼ 6 times

X	F1	F2
-6.4	-8.875	163.766
-6.3	-8.9	164.41
-6.2	-8.925	165.056
-6.1	-8.95	165.703
-5.9	-8.9	164.41
-5.9		
ZOOM		
BIG DEFN		

**To go directly to a value**

25. Move directly to X = 10.

10

X	F1	F2
9.5	-8.875	163.766
9.6	-8.9	164.41
9.7	-8.925	165.056
9.8	-8.95	165.703
9.9	-8.9	164.41
10	-8.9	164.41
10		
ZOOM		
BIG DEFN		

**To access the zoom options**

26. Zoom in on X = 10 by a factor of 4. *Note: NUMZOOM has a setting of 4.*

In

X	F1	F2
9.875	-8.875	163.766
9.9	-8.9	164.41
9.925	-8.925	165.056
9.95	-8.95	165.703
10	-8.9	164.41
10		
ZOOM		
BIG DEFN		

**To change font size**

27. Display table numbers in large font.

X	F1	F2
9.875	-8.875	163.766
9.9	-8.9	164.41
9.925	-8.925	165.056
9.95	-8.95	165.703
9.95		
ZOOM		
BIG DEFN		

**To display the symbolic definition of a column**

28. Display the symbolic definition for the F1 column.

▶

X	F1	F2
9.875	-8.875	163.766
9.9	-8.9	164.41
9.925	-8.925	165.056
9.95	-8.95	165.703
1-X		
ZOOM		
BIG DEFN		

The symbolic definition of F1 is displayed at the bottom of the screen.





## Function aplet interactive analysis

From the Plot view (**PLT**), you can use the functions on the FCN menu to find roots, intersections, slopes, and areas for a function defined in the Function aplet (and any Function-based aplets). See "FCN functions" on page 3-10. The FCN operations act on the currently selected graph.

The results of the FCN functions are saved in the following variables:

- Area
- Extremum
- Isect
- Root
- Slope

For example, if you use the Root function to find the root of a plot, you can use the result in calculations in HOME.

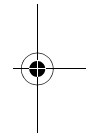
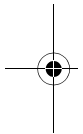
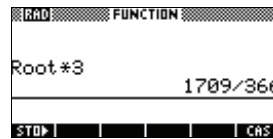

## Access FCN variables

The FCN variables are contained on the VARS menu.

To access FCN variables in HOME:

**VAR** **FCN**

Select Plot FCN



**▲** or **▼** to choose a

variable **OK**

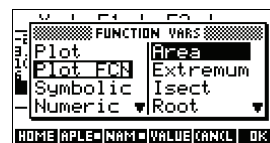

To access FCN variable in the Function aplet's Symbolic view:

**VAR**

Select Plot FCN



**▲** or **▼** to choose a variable

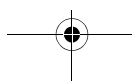



## FCN functions

The FCN functions are:

Function	Description
Root	Select <code>Root</code> to find the root of the current function nearest the cursor. If no root is found, but only an extremum, then the result is labeled <code>EXTR:</code> instead of <code>ROOT:</code> . (The root-finder is also used in the Solve applet. See also "Interpreting results" on page 7-6.) The cursor is moved to the root value on the x-axis and the resulting x-value is saved in a variable named <code>ROOT</code> .
Extremum	Select <code>Extremum</code> to find the maximum or minimum of the current function nearest the cursor. This displays the coordinate values and moves the cursor to the extremum. The resulting value is saved in a variable named <code>EXTREMUM</code> .
Slope	Select <code>Slope</code> to find the numeric derivative at the current position of the cursor. The result is saved in a variable named <code>SLOPE</code> .
Signed area	Select <code>Signed area</code> to find the numeric integral. (If there are two or more expressions checkmarked, then you will be asked to choose the second expression from a list that includes the x-axis.) Select a starting point, then move the cursor to selection ending point. The result is saved in a variable named <code>AREA</code> .

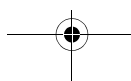
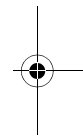
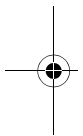



Function	Description (Continued)
Intersection	Select <b>Intersection</b> to find the intersection of two graphs nearest the cursor. (You need to have at least two selected expressions in Symbolic view.) Displays the coordinate values and moves the cursor to the intersection. (Uses Solve function.) The resulting x-value is saved in a variable named ISECT.

## Shading area

You can shade a selected area between functions. This process also gives you an approximate measurement of the area shaded.

1. Open the Function applet. The Function applet opens in the Symbolic view.
2. Select the expressions whose curves you want to study.
3. Press **PLOT** to plot the functions.
4. Press **◀** or **▶** to position the cursor at the starting point of the area you want to shade.
5. Press **AREA**.
6. Press **AREA**, then select **Signed area** and press **AREA**.
7. Press **AREA**, choose the function that will act as the boundary of the shaded area, and press **AREA**.
8. Press the **◀** or **▶** key to shade in the area.
9. Press **AREA** to calculate the area. The area measurement is displayed near the bottom of the screen.

To remove the shading, press **PLOT** to re-draw the plot.

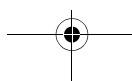
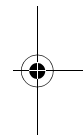
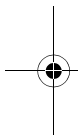

## Plotting a piecewise-defined function

Suppose you wanted to plot the following piecewise-defined function.

$$f(x) = \begin{cases} x+2 & ;x \leq -1 \\ x^2 & ;-1 < x \leq 1 \\ 4-x & ;x \geq 1 \end{cases}$$

1. Open the Function aplet.

**APLET** Select  
Function  
**ENTER**

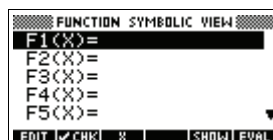

2. Highlight the line you want to use, and enter the expression. (You can press **DEL** to delete an existing line, or **SHIFT** CLEAR to clear all lines.)

**(** **+** **2** **)** **÷**  
**(** **+** **SHIFT** CHARS **≤**  
**(** **-** **1** **)** **ENTER**  
**X**<sup>2</sup> **÷** **(** **-** **1** **)**  
**SHIFT** CHARS **>** **(** **-** **1** **)**  
**SHIFT** AND **(** **+** **SHIFT** CHARS **≤** **1** **)** **ENTER**

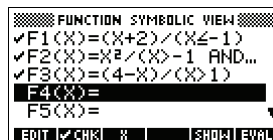

**(** **4** **-** **X** **)** **=** **(** **X**  
**SHIFT** CHARS **>** **1** **)**  
**ENTER**

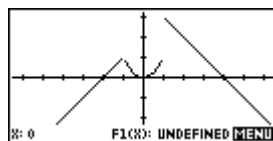

*Note: You can use the **+** menu key to assist in the entry of equations. It has the same effect as pressing*

**(X,T,θ)**.



# 4

## Parametric aplet

---

### About the Parametric aplet

The Parametric aplet allows you to explore parametric equations. These are equations in which both  $x$  and  $y$  are defined as functions of  $t$ . They take the forms  $x = f(t)$  and  $y = g(t)$ .

### Getting started with the Parametric aplet

The following example uses the parametric equations

$$\begin{aligned}x(t) &= 3 \sin t \\ y(t) &= 3 \cos t\end{aligned}$$

*Note: This example will produce a circle. For this example to work, the angle measure must be set to degrees.*

#### Open the Parametric aplet

1. Open the Parametric aplet.

Select  
Parametric



#### Define the expressions

2. Define the expressions.

3      
  
3

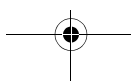
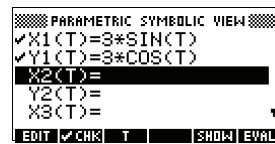



### Set angle measure

3. Set the angle measure to degrees.

**SHIFT** MODES

**CHOOSE**

Select Degrees **OK**



### Set up the plot

4. Display the graphing options.

**SHIFT** PLOT

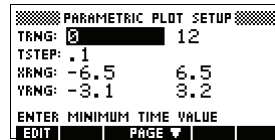

The Plot Setup input form has two fields not included in the Function aplet, TRNG and TSTEP. TRNG specifies the range of  $t$  values. TSTEP specifies the step value between  $t$  values.

5. Set the TRNG and TSTEP so that  $t$  steps from  $0^\circ$  to  $360^\circ$  in  $5^\circ$  steps.

**▶** 360 **OK**

5 **OK**

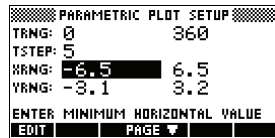

### Plot the expression

6. Plot the expression.

**PLOT**

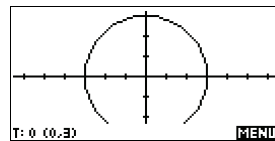

7. To see all the circle, press **MENU** twice.

**MENU** **MENU**

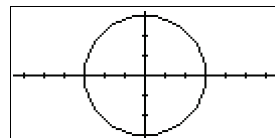



## Overlay plot

8. Plot a triangle graph over the existing circle graph.

**SHIFT** PLOT



120 **OK**

PARAMETRIC PLOT SETUP	
TRNG: 0	360
TSTEP: 120	
XRNG: -6.5	6.5
YRNG: -3.1	3.2
ENTER MINIMUM HORIZONTAL VALUE	
<b>EDIT</b>	<b>PAGE</b>

**VIEWS**

Select Overlay Plot



**MENU** **MENU**

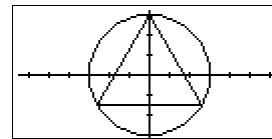

A triangle is displayed rather than a circle (without changing the equation) because the changed value of TSTEP ensures that points being plotted are 120° apart instead of nearly continuous.

You are able to explore the graph using trace, zoom, split screen, and scaling functionality available in the Function aplet. See “Exploring the graph” on page 2-7 for further information.

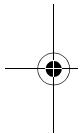

## Display the numbers

9. Display the table of values.

**NUM**

You can highlight a *t*-value, type in a replacement value, and see the table jump to that value. You can also zoom in or zoom out on any *t*-value in the table.

T	X1	Y1
0	0	0
1	.005226	2.999995
2	.010472	2.999982
3	.015707	2.999959
4	.020943	2.999927
5	.026179	2.999886
6		

You are able to explore the table using **EDIT**, **EDIT**, build your own table, and split screen functionality available in the Function aplet. See “Exploring the table of numbers” on page 2-17 for further information.

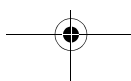
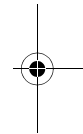

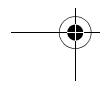
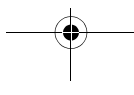
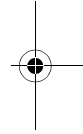
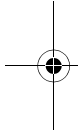
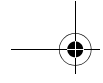



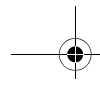

# 5

## Polar aplet

### Getting started with the Polar aplet

#### Open the Polar aplet

1. Open the Polar aplet.

**APLET** *Select Polar*

**RESET** **YES** **START**  
Like the Function aplet, the Polar aplet opens in the Symbolic view.

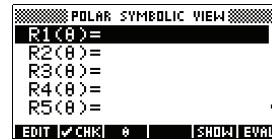

#### Define the expression

2. Define the polar equation  $r = 2\pi \cos(\theta/2) \cos(\theta)^2$ .

2 **SHIFT** **π** **COS**  
**X,T,θ** **÷** 2 **)**  
**COS** **X,T,θ** **)**  
**X<sup>2</sup>** **ENTER**

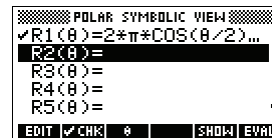

#### Specify plot settings

3. Specify the plot settings. In this example, we will use the default settings, except for the **θRNG** fields.

**SHIFT** *SETUP-PLOT*  
**SHIFT** *CLEAR*  
4 **SHIFT** **π** **MODE**

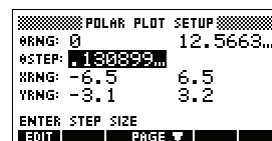

#### Plot the expression

4. Plot the expression.

**PLOT**

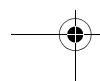
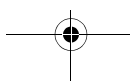
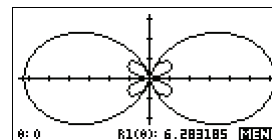



## Explore the graph

5. Display the Plot view menu key labels.

**MENU**

The Plot view options available are the same as those found in the Function aplet. See "Exploring the graph" on page 2-7 for further information.

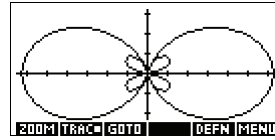

## Display the numbers

6. Display the table of values for  $\theta$  and R1.

**NUM**

The Numeric view options available are the same as those found in the Function aplet. See "Exploring the table of numbers" on page 2-17 for further information.

$\theta$	R1		
0	2.88185		
1	2.12784		
2	0.05094		
3	0.670064		
4	0.224109		
5	4.68857		

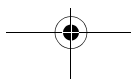
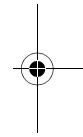
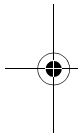



## 6

# Sequence aplet

---

## About the Sequence aplet

The Sequence aplet allows you to explore sequences.

You can define a sequence named, for example, U1:

- in terms of  $n$
- in terms of  $U1(n-1)$
- in terms of  $U1(n-2)$
- in terms of another sequence, for example,  $U2(n)$
- in any combination of the above.

The Sequence aplet allows you to create two types of graphs:

- A **Stairsteps** graph plots  $n$  on the horizontal axis and  $U_n$  on the vertical axis.
- A **Cobweb** graph plots  $U_{n-1}$  on the horizontal axis and  $U_n$  on the vertical axis.

## Getting started with the Sequence aplet

The following example defines and then plots an expression in the Sequence aplet. The sequence illustrated is the well-known Fibonacci sequence where each term, from the third term on, is the sum of the preceding two terms. In this example, we specify three sequence fields: the first term, the second term and a rule for generating all subsequent terms.

However, you can also define a sequence by specifying just the first term and the rule for generating all subsequent terms. You will, though, have to enter the second term if the hp40gs is unable to calculate it automatically. Typically if the  $n$ th term in the sequence depends on  $n-2$ , then you must enter the second term.

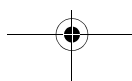
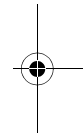
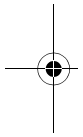

## Open the Sequence aplet

1. Open the Sequence aplet.

**APLET** *Select*  
 Sequence  
**START**

The Sequence aplet starts in the Symbolic view.

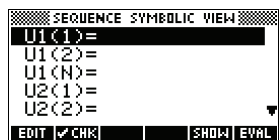

## Define the expression

2. Define the Fibonacci sequence, in which each term (after the first two) is the sum of the preceding two terms:

$$U_1 = 1, U_2 = 1, U_n = U_{n-1} + U_{n-2} \text{ for } n > 3.$$

In the Symbolic view of the Sequence aplet, highlight the U1(1) field and begin defining your sequence.

1 **ENTER** 1 **ENTER**  
**U1** **⟨N-1⟩** **+** **U1**  
**⟨N-2⟩**

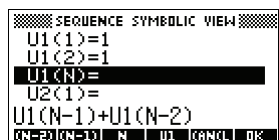

*Note: You can use the*

**⟨N⟩**, **⟨N-2⟩**, **⟨N-1⟩**,

**U1**, and **U2** menu keys to assist in the entry of equations.

**ENTER**

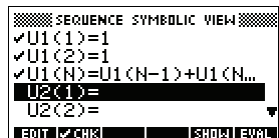

## Specify plot settings

3. In Plot Setup, first set the SEQPLOT option to Stairstep. Reset the default plot settings by clearing the Plot Setup view.

**SHIFT** *SETUP-PLOT*  
**SHIFT** *CLEAR*  
**↓** **▶** 8 **ENTER**  
**▶** 8 **ENTER**

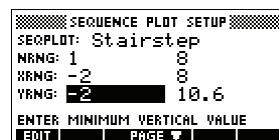



## Plot the sequence

- Plot the Fibonacci sequence.

**PLOT**

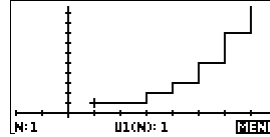

- In Plot Setup, set the SEQPLOT option to Cobweb.

**SHIFT** *SETUP-PLOT*

**CHOOS** *Select Cobweb*

**OK**

**PLOT**

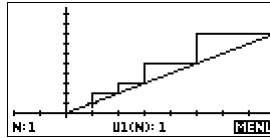

## Display the table

- Display the table of values for this example.

**NUM**

N	U1		
1	1		
2	1		
3	2		
4	3		
5	5		
6	8		
7	13		
8	21		
9	34		
10	55		
11	89		
12	144		
13	233		
14	377		
15	610		
16	987		
17	1597		
18	2584		
19	4181		
20	6765		
21	10946		
22	17711		
23	28657		
24	46368		
25	75025		
26	121393		
27	196418		
28	317811		
29	514130		
30	821313		
31	1304960		
32	2088183		
33	3309377		
34	5247460		
35	8225743		
36	12747603		
37	19875346		
38	30517081		
39	46792527		
40	71808068		
41	110001496		
42	168810165		
43	257689333		
44	394497600		
45	596197440		
46	895695040		
47	1346891520		
48	2032586560		
49	3038478080		
50	4541064640		
51	6812543200		
52	10213607840		
53	15306151040		
54	22719758880		
55	34233410240		
56	51453169120		
57	77086679360		
58	115140838720		
59	173227518080		
60	261368356800		
61	392589195520		
62	584957552320		
63	874546747840		
64	1303504300160		
65	1957050848000		
66	2910555148800		
67	4313059397760		
68	6433614546560		
69	9526673795360		
70	14160288342080		
71	21316962137440		
72	31877250480000		
73	47793532617440		
74	71070783097920		
75	106248035715360		
76	158418818813280		
77	235666854528640		
78	350885673341920		
79	520154528060160		
80	770039191402080		
81	1140193719462240		
82	1700232810864320		
83	2540426520326560		
84	3740669331190880		
85	5520912142055040		
86	8161571473245920		
87	12162233615436800		
88	18162905088682720		
89	27025138704119520		
90	40188043792802240		
91	59613182496921760		
92	88011226289724000		
93	130000408786645760		
94	192011635076369760		
95	282013043863015520		
96	418024678939384320		
97	616036322802400000		
98	914047966665416000		
99	1352059610528432000		
100	2014081577193848000		

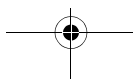
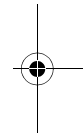
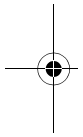

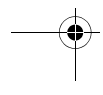
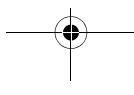
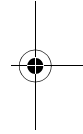
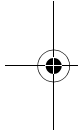
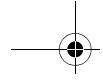



# 7

## Solve aplet

---

### About the Solve aplet

The Solve aplet solves an equation or an expression for its *unknown variable*. You define an equation or expression in the symbolic view, then supply values for all the variables *except one* in the numeric view. Solve works only with real numbers.

Note the differences between an equation and an expression:

- An *equation* contains an equals sign. Its solution is a value for the unknown variable that makes both sides have the same value.
- An *expression* does not contain an equals sign. Its solution is a *root*, a value for the unknown variable that makes the expression have a value of zero.

You can use the Solve aplet to solve an equation for any one of its variables.

When the Solve aplet is started, it opens in the Solve Symbolic view.

- In Symbolic view, you specify the expression or equation to solve. You can define up to ten equations (or expressions), named E0 to E9. Each equation can contain up to 27 real variables, named A to Z and  $\theta$ .
- In Numeric view, you specify the values of the known variables, highlight the variable that you want to solve for, and press **SOLVE**.

You can solve the equation as many times as you want, using new values for the knowns and highlighting a different unknown.

*Note: It is not possible to solve for more than one variable at once. Simultaneous linear equations, for example, should be solved using the Linear Solver aplet, matrices or graphs in the Function aplet.*

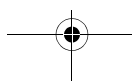
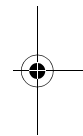
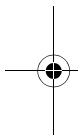

## Getting started with the Solve aplet

Suppose you want to find the acceleration needed to increase the speed of a car from 16.67 m/sec (60 kph) to 27.78 m/sec (100 kph) in a distance of 100 m.

The equation to solve is:

$$v^2 = U^2 + 2AD$$

### Open the Solve aplet

1. Open the Solve aplet.

**APLET** *Select Solve*  
**SOLVE**



The Solve aplet starts in the symbolic view.

### Define the equation

2. Define the equation.

**ALPHA** **V** **X<sup>2</sup>**  
**⌘** **ALPHA** **U** **X<sup>2</sup>**  
**+** **2** **X**  
**ALPHA** **A** **X**  
**ALPHA** **D** **ENTER**

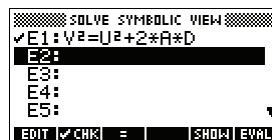

*Note: You can use the **⌘** menu key to assist in the entry of equations.*

### Enter known variables

3. Display the Solve numeric view screen.

**NUM**

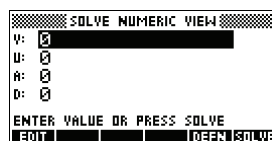





4. Enter the values for the known variables.

27  78

16  67

100

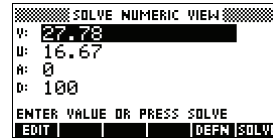

**HINT**

If the Decimal Mark setting in the Modes input form ( *MODES*) is set to Comma, use  instead of .

**Solve the unknown variable**

5. Solve for the unknown variable (*A*).

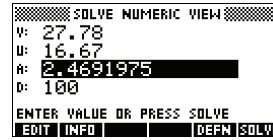

Therefore, the acceleration needed to increase the speed of a car from 16.67 m/sec (60 kph) to 27.78 m/sec (100 kph) in a distance of 100 m is approximately 2.47 m/s<sup>2</sup>.

Because the variable *A* in the equation is linear we know that we need not look for any other solutions.

**Plot the equation**

The Plot view shows one graph for each side of the selected equation. You can choose any of the variables to be the independent variable.

The current equation is  $V^2 = U^2 + 2AD$ .

One of these is  $Y = V^2$ , with  $V = 27.78$ , that is,  $Y = 771.7284$ . This graph will be a horizontal line.

The other graph will be  $Y = U^2 + 2AD$ , with  $U = 16.67$  and  $D = 100$ , that is,

$Y = 200A + 277.8889$ . This graph is also a line. The desired solution is the value of *A* where these two lines intersect.

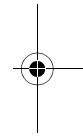
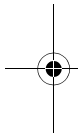



6. Plot the equation for variable  $A$ .

**VIEWS** *Select Auto*  
Scale  
**MODE**

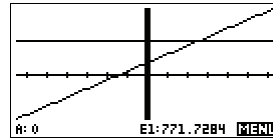

7. Trace along the graph representing the left side of the equation until the cursor nears the intersection.

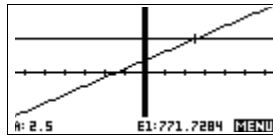

**▶**  $\approx 20$  times

Note the value of  $A$  displayed near the bottom left corner of the screen.

The Plot view provides a convenient way to find an approximation to a solution instead of using the Numeric view Solve option. See "Plotting to find guesses" on page 7-7 for more information.

## Solve aplet's NUM view keys

The Solve aplet's NUM view keys are:

Key	Meaning
<b>EDIT</b>	Copies the highlighted value to the edit line for editing. Press <b>OK</b> when done.
<b>INFO</b>	Displays a message about the solution (see "Interpreting results" on page 7-6).
<b>PAGE</b>	Displays other pages of variables, if any.
<b>DEFN</b>	Displays the symbolic definition of the current expression. Press <b>OK</b> when done.
<b>SOLVE</b>	Finds a solution for the highlighted variable, based on the values of the other variables.

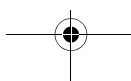
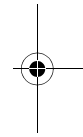
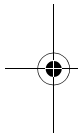



Key	Meaning (Continued)
	Clears highlighted variable to zero or deletes current character in edit line, if edit line is active.
	Resets all variable values to zero or clears the edit line, if cursor is in edit line.

## Use an initial guess

You can usually obtain a faster and more accurate solution if you supply an estimated value for the unknown variable *before* pressing . Solve starts looking for a solution at the initial guess.

Before plotting, make sure the unknown variable is highlighted in the numeric view. Plot the equation to help you select an initial guess when you don't know the range in which to look for the solution. See "Plotting to find guesses" on page 7-7 for further information.

### HINT

An initial guess is especially important in the case of a curve that could have more than one solution. In this case, only the solution closest to the initial guess is returned.

## Number format

You can change the number format for the Solve aplet in the Numeric Setup view. The options are the same as in HOME MODES: Standard, Fixed, Scientific, Engineering, Fraction and Mixed Fraction. For all except Standard, you also specify how many digits of accuracy you want. See "Mode settings" on page 1-10 for more information.

You might find it handy to set a different number format for the Solve aplet if, for example, you define equations to solve for the value of money. A number format of Fixed 2 would be appropriate in this case.

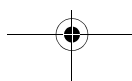
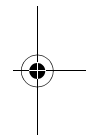
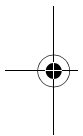





If Solve could not find a solution, you will see one of the following two messages.

Message	Condition
Bad Guess(es)	The initial guess lies outside the domain of the equation. Therefore, the solution was not a real number or it caused an error.
Constant?	The value of the equation is the same at every point sampled.

### HINT

It is important to check the information relating to the solve process. For example, the solution that the Solve aplet finds is not a solution, but the closest that the function gets to zero. Only by checking the information will you know that this is the case.

## The Root-Finder at work

You can watch the process of the root-finder calculating and searching for a root. Immediately after pressing **SOLVE** to start the root-finder, press any key except **ON**. You will see two intermediate guesses and, to the left, the sign of the expression evaluated at each guess. For example:

```
+ 2 2.219330555745
- 1 21.31111111149
```

You can watch as the root-finder either finds a sign reversal or converges on a local extrema or does not converge at all. If there is no convergence in process, you might want to cancel the operation (press **ON**) and start over with a different initial guess.

## Plotting to find guesses

The main reason for plotting in the Solve aplet is to help you find initial guesses and solutions for those equations that have difficult-to-find or multiple solutions.

Consider the equation of motion for an accelerating body:

$$X = V_0T + \frac{AT^2}{2}$$

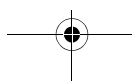

where  $X$  is distance,  $V_0$  is initial velocity,  $T$  is time, and  $A$  is acceleration. This is actually two equations,  $Y = X$  and  $Y = V_0 T + (AT^2)/2$ .

Since this equation is quadratic for  $T$ , there can be both a positive and a negative solution. However, we are concerned only with positive solutions, since only positive distance makes sense.

1. Select the Solve aplet and enter the equation.

[APLET] Select Solve [SOLVE]

[ALPHA] X [ ]

[ALPHA] V [ ]

[ALPHA] T [ ]

[ALPHA] A

[ ] [ALPHA] T [X<sup>2</sup>] [ ] 2 [ ]

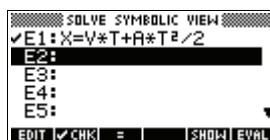

2. Find the solution for  $T$  (time) when  $X=30$ ,  $V=2$ , and  $A=4$ . Enter the values for  $X$ ,  $V$ , and  $A$ ; then highlight the independent variable,  $T$ .

[NUM]

30 [ENTER]

2 [ENTER]

[ ] 4 [ENTER]

[ ] [ ] to highlight  $T$

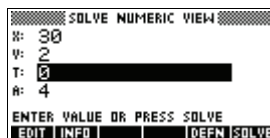

3. Use the Plot view to find an initial guess for  $T$ . First set appropriate  $X$  and  $Y$  ranges in the Plot Setup. With equation  $X = V \times T + A \times T^2 / 2$ , the plot will produce two graphs: one for  $Y = X$  and one for  $X = V \times T + A \times T^2 / 2$ . Since we have set  $X = 30$  in this example, one of the graphs will be  $Y = 30$ . Therefore, make the  $YRNG$   $-5$  to  $35$ . Keep the  $XRNG$  default of  $-6.5$  to  $6.5$ .

[SHIFT] SETUP-*PLOT*

[ ] [(-)] 5 [ENTER] 35

[ENTER]

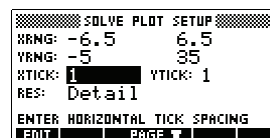

4. Plot the graph.

[PLOT]



- Move the cursor near the positive (right-side) intersection. This cursor value will be an initial guess for  $T$ .

Press until the cursor is at the intersection.

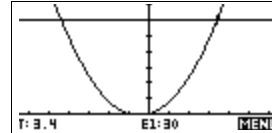

The two points of intersection show that there are two solutions for this equation. However, only positive values for  $X$  make sense, so we want to find the solution for the intersection on the right side of the  $y$ -axis.

- Return to the Numeric view.

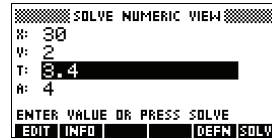

*Note: the  $T$ -value is filled in with the position of the cursor from the Plot view.*

- Ensure that the  $T$  value is highlighted, and solve the equation.

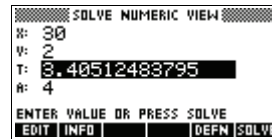

Use this equation to solve for another variable, such as velocity. How fast must a body's initial velocity be in order for it to travel 50 m within 3 seconds? Assume the same acceleration,  $4 \text{ m/s}^2$ . Leave the last value of  $V$  as the initial guess.

3

50

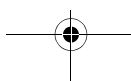



## Using variables in equations

You can use any of the real variable names, A to Z and  $\theta$ . Do not use variable names defined for other types, such as M1 (a matrix variable).

### Home variables

All home variables (other than those for aplet settings, like `Xmin` and `Ytick`) are *global*, which means they are *shared* throughout the different aplets of the calculator. A value that is assigned to a home variable anywhere remains with that variable wherever its name is used.

Therefore, if you have defined a value for  $T$  (as in the above example) in another aplet or even another Solve equation, that value shows up in the Numeric view for this Solve equation. When you then redefine the value for  $T$  in this Solve equation, that value is applied to  $T$  in all other contexts (until it is changed again).

This sharing allows you to work on the same problem in different places (such as HOME and the Solve aplet) without having to update the value whenever it is recalculated.

### HINT

As the Solve aplet uses existing variable values, be sure to check for existing variable values that may affect the solve process. (You can use `[SHIFT] CLEAR` to reset all values to zero in the Solve aplet's Numeric view if you wish.)

### Aplet variables

Functions defined in other aplets can also be referenced in the Solve aplet. For example, if, in the Function aplet, you define  $F1(X) = X^2 + 10$ , you can enter  $F1(X) = 50$  in the Solve aplet to solve the equation  $X^2 + 10 = 50$ .

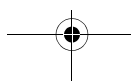
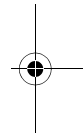
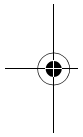





## Linear Solver applet

### About the Linear Solver applet

The Linear Solver applet allows you to solve a set of linear equations. The set can contain two or three linear equations.

In a two-equation set, each equation must be in the form  $ax + by = k$ . In a three-equation set, each equation must be in the form  $ax + by + cz = k$ .

You provide values for  $a$ ,  $b$ , and  $k$  (and  $c$  in three-equation sets) for each equation, and the Linear Solver applet will attempt to solve for  $x$  and  $y$  (and  $z$  in three-equation sets).

The hp40gs will alert you if no solution can be found, or if there is an infinite number of solutions.

Note that the Linear Solver applet only has a numeric view.

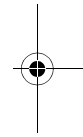
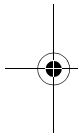

### Getting started with the Linear Solver applet

The following example defines a set of three equations and then solves for the unknown variables.

#### Open the Linear Solver applet

1. Open the Linear Sequence applet.

**APLET** Select Linear Solver

**START**

The Linear Equation Solver opens.

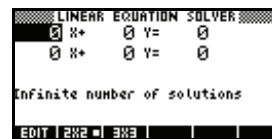

#### Choose the equation set

2. If the last time you used the Linear Solver applet you solved for two equations, the two-equation input form is displayed (as in the

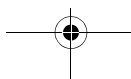
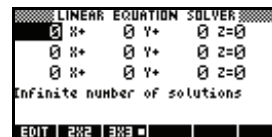

## Define and solve the equations

example in the previous step). To solve a three-equation set, press **EQN**. Now the input form displays three equations.

If the three-equation input form is displayed and you want to solve a two-equation set, press **EQ2**.

In this example, we are going to solve the following equation set:

$$6x + 9y + 6z = 5$$

$$7x + 10y + 8z = 10$$

$$6x + 4y = 6$$

Hence we need the three-equation input form.

3. You define the equations you want to solve by entering the co-efficients of each variable in each equation and the constant term. Notice that the cursor is immediately positioned at the co-efficient of x in the first equation. Enter that co-efficient and press **OK** or **ENTER**.
4. The cursor moves to the next co-efficient. Enter that co-efficient, press **OK** or **ENTER**, and continue doing likewise until you have defined all the equations.

*Note:* you can enter the name of a variable for any co-efficient or constant. Press **ALPHA** and begin entering the name. The **ALPHA** menu key appears. Press that key to lock alphabetic entry mode. Press it again to cancel the lock.

Once you have entered enough values for the solver to be able to generate solutions, those solutions appear on the display. In the example at the right, the solver was able to find solutions for x, y, and z as soon as the first co-efficient of the last equation was entered.

LINEAR EQUATION SOLVER			
6	X+	9	Y+ 6 Z=5
7	X+	10	Y+ 8 Z=10
6	X+	0	Y+ 0 Z=0
X=0	Y=-1.66666	Z=3.33333	
EDIT   2ND   EQN			



As you enter each of the remaining known values, the solution changes. The example at the right shows the final solution once all the co-efficients and constants are entered for the set of equations we set out to solve.

```
LINEAR EQUATION SOLVER
3 X+ 9 Y+ 6 Z=5
7 X+ 10 Y+ 8 Z=10
6 X+ 4 Y+ 0 Z=6
X=2.166666 Y=-3.25 Z=2.541666
EDIT 2ND 3RD
```

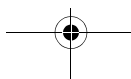
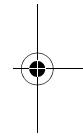
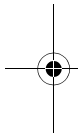

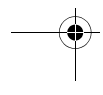
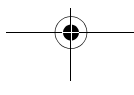
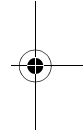
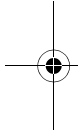
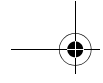



## Triangle Solve aplet

---

### About the Triangle Solver aplet

The Triangle Solver aplet allows you to determine the length of a side of a triangle, or the angle at the vertex of a triangle, from information you supply about the other lengths and/or other angles.

You need to specify at least three of the six possible values—the lengths of the three sides and the size of the three angles—before the solver can calculate the other values. Moreover, at least one value you specify must be a length. For example, you could specify the lengths of two sides and one of the angles; or you could specify two angles and one length; or all three lengths. In each case, the solver will calculate the remaining lengths or angles.

The HP 40gs will alert you if no solution can be found, or if you have provided insufficient data.

If you are determining the properties of a right-angled triangle, a simpler input form is available by pressing the **RECT** menu key.

Note that the Triangle Solver aplet only has a numeric view.

### Getting started with the Triangle Solver aplet

The following example solves for the unknown length of the side of a triangle whose two known sides—of lengths 4 and 6—meet at an angle of 30 degrees.

*Before you begin:* You should make sure that your angle measure mode is appropriate. If the angle information you have is in degrees (as in this example) and your current angle measure mode is radians or grads, change the mode to degrees before running the solver. (See “Mode settings” on page 1-10 for instructions.) Because the angle measure mode is associated with the aplet, you should start the aplet first and then change the setting.

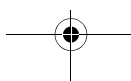
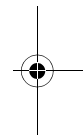
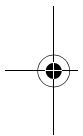

## Open the Triangle Solver Aplet

1. Open the Triangle Solver aplet.

**APLET** Select  
Triangle Solver  
**START**



The Triangle Solver aplet opens.

*Note:* if you have already used the Triangle Solver, the entries and results from the previous use will still be displayed. To start the Triangle Solver afresh, clear the previous entries and results by pressing **SHIFT** **CLEAR**.

## Choose the triangle type

2. If the last time you used the Triangle Solver aplet you used the right-angled triangle input form, that input form is displayed again (as in the



example at the right). If the triangle you are investigating is not a right-angled triangle, or you are not sure what type it is, you should use the general input form (illustrated in the previous step). To switch to the general input form, press **RECT**.

If the general input form is displayed and you are investigating a right-angled triangle, press **RECT** to display the simpler input form.

## Specify the known values

3. Using the arrow keys, move to a field whose value you know, enter the value and press **OK** or **ENTER**. Repeat for each known value.

Note that the lengths of the sides are labeled  $A$ ,  $B$ , and  $C$ , and the angles are labeled  $\alpha$ ,  $\beta$ , and  $\delta$ . It is important that you enter the known values in the



appropriate fields. In our example, we know the length of two sides and the angle at which those sides meet. Hence if we specify the lengths of sides  $A$  and  $B$ , we must enter the angle as  $\delta$  (since  $\delta$  is the angle where  $A$  and  $B$  meet). If instead we entered the



lengths as B and C, we would need to specify the angle as  $\alpha$ . The illustration on the display will help you determine where to enter the known values.

Note: if you need to change the angle measure mode, press **SHIFT** **MODES**, change the mode, and then press **NUM** to return to the aplet.

- Press **SOLVE**. The solver calculates the values of the unknown variables and displays. As the illustration at the right shows, the length of the unknown side in our example is 3.2296. (The other two angles have also been calculated.)



**Note:** if two sides and an adjacent acute angle are entered and there are two solutions, only one will be displayed initially.



In this case, an **ALT** menu key is displayed (as in this example). You press **ALT** to display the second solution, and **ALT** again to return to the first solution.

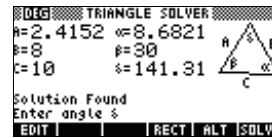

## Errors

### No solution with given data

If you are using the general input form and you enter more than 3 values, the values might not be consistent, that is, no triangle could possibly have all the values you specified. In these cases, No sol with given data appears on the screen.



The situation is similar if you are using the simpler input form (for a right-angled triangle) and you enter more than two values.

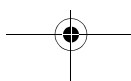



### Not enough data

If you are using the general input form, you need to specify at least three values for the Triangle Solver to be able to calculate the remaining attributes of the triangle. If you specify less than three, Not enough data appears on the screen.



If you are using the simplified input form (for a right-angled triangle), you must specify at least two values.

In addition, you cannot specify only angles and no lengths.

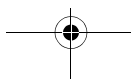
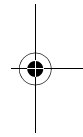
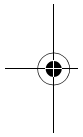





# 10

## Statistics aplet

---

### About the Statistics aplet

The Statistics aplet can store up to ten data sets at one time. It can perform one-variable or two-variable statistical analysis of one or more sets of data.

The Statistics aplet starts with the Numeric view which is used to enter data. The Symbolic view is used to specify which columns contain data and which column contains frequencies.

You can also compute statistics values in HOME and recall the values of specific statistics variables.

The values computed in the Statistics aplet are saved in variables, and many of these variables are listed by the **STATS** function accessible from the Statistics aplet's Numeric view screen.

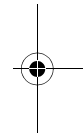
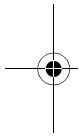

### Getting started with the Statistics aplet

The following example asks you to enter and analyze the advertising and sales data (in the table below), compute statistics, fit a curve to the data, and predict the effect of more advertising on sales.

Advertising minutes (independent, x)	Resulting Sales (\$) (dependent, y)
2	1400
1	920
3	1100
5	2265
5	2890
4	2200

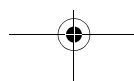



## Open the Statistics aplet

1. Open the Statistics aplet and clear existing data by pressing **RESET**.

Select Statistics

n	C1	C2	C3	C4
1				

The Statistics aplet starts in the Numerical view.

1VAR/2VAR menu key label

At any time the Statistics aplet is configured for only one of two types of statistical explorations: one-variable (**1VAR**) or two-variable (**2VAR**). The 5th menu key label in the Numeric view toggles between these two options and shows the current option.

2. Select **2VAR**.

You need to select **2VAR** because in this example we are analyzing a dataset comprising two variables: advertising minutes and resulting sales.

## Enter data

3. Enter the data into the columns.

2  1   
 3  5   
 5  4

n	C1	C2	C3	C4
1		1400		
2		420		
3		1100		
4		2265		
5		2890		
6		2200		
1400				

to move to the next column

1400  920   
 1100  2265   
 2890  2200

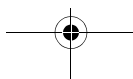
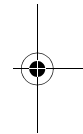
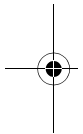

## Choose fit and data columns

4. Select a fit in the Symbolic setup view.

SHIFT SETUP-SYMB  
 ▾ CHOOSE  
 Select Linear  
 OK

```

STATISTICS SYMBOLIC SETUP
ANGLE MEASURE: Radians
S1FIT: Linear  S2FIT: Linear
S3FIT: Linear  S4FIT: Linear
S5FIT: Linear
CHOOSE STATISTICS MODEL TYPE
CHOOSE
    
```

You can create up to five explorations of two-variable data, named S1 to S5. In this example, we will create just one: S1.

5. Specify the columns that hold the data you want to analyze.

SYMB  
 You could have entered your data into columns other than C1 and C2.

```

STATISTICS SYMBOLIC VIEW
S1: C1  C2
Fit1: m*X+b
S2:
Fit2: m*X+b
ENTER INDEPENDENT
EDIT  CHG  c  SHOW EVAL
    
```

## Explore statistics

6. Find the mean advertising time (MEANX) and the mean sales (MEANY).

NUM **STATS**  
 MEANX is 3.3 minutes and MEANY is about \$1796.

Z-VAR	S1		
MEANX	3.333333		
SX	80		
SX2	80		
MEANY	1795.833		
SY	10275		
SY2	22338725		
	3.333333333333		
			OK

7. Scroll down to display the value for the correlation coefficient (CORR). The CORR value indicates how well the linear model fits the data.

▾ 9 times  
 The value is .8995.

Z-VAR	S1		
SY2	22338725		
SY	41595		
SCOV	1135.667		
PCOV	846.889		
CORR	.899504		
RELERR	.025524		
	.899530938561		
			OK

## Setup plot

8. Change the plotting range to ensure all the data points are plotted (and select a different point mark, if you wish).

**SHIFT** **SETUP-PLOT**

**7** **ENTER**

**(-)** **100** **ENTER**

**4000** **ENTER**

```

STATISTICS PLOT SETUP
RANG: -2      7
YRNG: -100   4000
SMARK: ■    SEMARK: ✕    SEMARK: +
SMARK: ■    SEMARK: ✕
CHOOSE MARK FOR SCATTER PLOT
      CHOOSE MARK FOR SCATTER PLOT
      CHOOSE MARK FOR SCATTER PLOT
  
```

## Plot the graph

9. Plot the graph.

**PLOT**

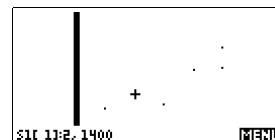

## Draw the regression curve

10. Draw the regression curve (a curve to fit the data points).

**MENU** **FIT**



This draws the regression line for the best linear fit.

## Display the equation for best linear fit

11. Return to the Symbolic view.

**SYMB**

```

STATISTICS SYMBOLIC VIEW
✓S1: C1      C2
✓Fit1: 425.875*X+376...
S2:
Fit2: m*X+b
ENTER INDEPENDENT
EDIT ✓CHK C SHOW EVAL
  
```

12. Display the equation for the best linear fit.

**▼** to move to the **FIT1** field

**SHOW**

```

425.875*X+376.25
  
```

The full **FIT1** expression is shown. The slope ( $m$ ) is 425.875. The y-intercept ( $b$ ) is 376.25.



### Predict values

13. To find the predicted sales figure if advertising were to go up to 6 minutes:

**2nd** HOME

**MATH** S (to highlight Stat-Two)

**▶** **▲** (to highlight PREDY)

**2nd** 6 ENTER

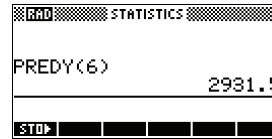

14. Return to the Plot view.

**PLOT**

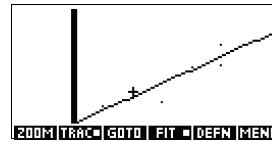

15. Jump to the indicated point on the regression line.

**▼** **GOTO**  
6



**2nd**

Observe the predicted y-value in the left bottom corner of the screen.

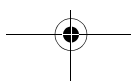
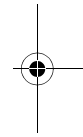
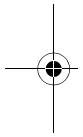
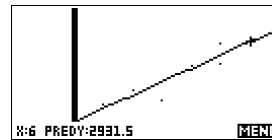



## Entering and editing statistical data

The Numeric view (**NUM**) is used to enter data into the Statistics applet. Each column represents a variable named C0 to C9. After entering the data, you must define the data set in the Symbolic view (**SYMB**).

### HINT

A data column must have at least four data points to provide valid two-variable statistics, or two data points for one-variable statistics.

You can also store statistical data values by copying lists from HOME into Statistics data columns. For example, in HOME, **L1 STO>** C1 stores a copy of the list L1 into the data-column variable C1.

## Statistics applet's NUM view keys

The Statistics applet's Numeric view keys are:

Key	Meaning
<b>EDIT</b>	Copies the highlighted item into the edit line.
<b>INS</b>	Inserts a zero value above the highlighted cell.
<b>SORT</b>	Sorts the specified <i>independent</i> data column in ascending or descending order, and rearranges a specified dependent (or frequency) data column accordingly.
<b>SIZE</b>	Switches between larger and smaller font sizes.
<b>1VAR</b> <b>2VAR</b>	A toggle switch to select one-variable or two-variable statistics. This setting affects the statistical calculations and plots. The label indicates which setting is current.
<b>STATS</b>	Computes descriptive statistics for each data set specified in Symbolic view.

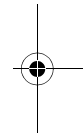
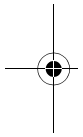



Key	Meaning (Continued)
<b>DEL</b>	Deletes the currently highlighted value.
<b>SHIFT</b> CLEAR	Clears the current column or all columns of data. Press <b>SHIFT</b> CLEAR to display a menu list, then select the current column or all columns option, and press <b>OK</b> .
<b>SHIFT</b> cursor key	Moves to the first or last row, or first or last column.

### Example

You are measuring the height of students in a classroom to find the mean height. The first five students have the following measurements 160cm, 165cm, 170cm, 175cm, 180cm.

1. Open the Statistics aplet.

```

APLET Select
Statistics
RESET YES
START
    
```

n	C1	C2	C3	C4
1				

EDIT INS SORT BIG LVAR=STATS

2. Enter the measurement data.

```

160 ENTER
165 ENTER
170 ENTER
175 ENTER
180 ENTER
    
```

n	C1	C2	C3	C4
1	160			
2	165			
3	170			
4	175			
5	180			

EDIT INS SORT BIG LVAR=STATS

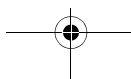
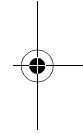
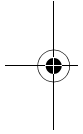

- Find the mean of the sample.

1-VAR	H1		
NΣ	5		
TOTΣ	850		
MEANΣ	170		
PVARΣ	50		
SVARΣ	62.5		
PSDEV	7.071068		
	5		
OK			

Ensure the **DATA** / **EDIT** menu key label reads **DATA**. Press **STAT** to see the statistics calculated from the sample data in C1.

Note that the title of the column of statistics is H1. There are 5 data set definitions available for one-variable statistics: H1-H5. If

1-VAR	H1		
SSDEV	7.905694		
MINΣ	160		
Q1	162.5		
MEDIAN	170		
Q3	172.5		
MAXΣ	180		
	180		
OK			

data is entered in C1, H1 is automatically set to use C1 for data, and the frequency of each data point is set to 1. You can select other columns of data from the Statistics Symbolic setup view.

- Press **QUIT** to close the statistics window and press **SYMB** key to see the data set definitions.

STATISTICS SYMBOLIC VIEW	
✓ H1:	C1 1
H2:	1
H3:	1
H4:	1
ENTER SAMPLE	
EDIT	✓CHK C SHOW EVAL

The first column indicates the associated column of data for each data set definition, and the second column indicates the constant frequency, or the column that holds the frequencies.

The keys you can use from this window are:

Key	Meaning
<b>EDIT</b>	Copies the column variable (or variable expression) to the edit line for editing. Press <b>QUIT</b> when done.
<b>✓CHK</b>	Checks/unchecks the current data set. Only the checkmarked data set(s) are computed and plotted.
<b>C</b> or <b>Σ</b>	Typing aid for the column variables ( <b>C</b> ) or for the Fit expressions ( <b>Σ</b> ).



Key	Meaning (Continued)
<b>SHOW</b>	Displays the current variable expression in standard mathematical form. Press <b>END</b> when done.
<b>EVAL</b>	Evaluates the variables in the highlighted column (C1, etc.) expression.
<b>VAR</b>	Displays the menu for entering variable names or contents of variables.
<b>MATH</b>	Displays the menu for entering math operations.
<b>DEL</b>	Deletes the highlighted variable or the current character in the edit line.
<b>SHIFT</b> CLEAR	Resets default specifications for the data sets or clears the edit line (if it was active). <i>Note: If <b>SHIFT</b> CLEAR is used the data sets will need to be selected again before re-use.</i>

To continue our example, suppose that the heights of the rest of the students in the class are measured, but each one is rounded to the nearest of the five values first recorded. Instead of entering all the new data in C1, we shall simply add another column, C2, that holds the frequencies of our five data points in C1.

Height (cm)	Frequency
160	5
165	3
170	8
175	2
180	1

- Move the highlight bar into the right column of the H1 definition and replace the frequency value of 1 with the name C2.

H1	C1	C2
H2:	1	
H3:	1	
H4:	1	

**2**

- Return to the numeric view.

**NUM**

- Enter the frequency data shown in the above table.

**5** **ENTER**

**3** **ENTER**

**8** **ENTER**

**2** **ENTER**

**1** **ENTER**

n	C1	C2	C3	C4
1	160			
2	165			
3	170			
4	175			
5	180			

- Display the computed statistics.

**STATS**

The mean height is approximately 167.63cm.

1-VAR	H1
MEAN	167.6316
SD	167.631578947

- Setup a histogram plot for the data.

**2** **SHIFT** **SETUP-PLT**

Enter set up information appropriate to your data.

STATPLOT	Hist	HWIDTH	5
XRNG	160	185	
YRNG	-2	10	
HRNG	160	185	

- Plot a histogram of the data.

**PLOT**

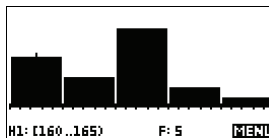

## Save data

The data that you enter is automatically saved. When you are finished entering data values, you can press a key for another Statistics view (like **SYMB**), or you can switch to another aplet or HOME.



## Edit a data set

In the Numeric view of the Statistics applet, highlight the data value to change. Type a new value and press **ENTER**, or press **EDIT** to copy the value to the edit line for modification. Press **ENTER** after modifying the value on the edit line.

## Delete data

- To delete a single data item, highlight it and press **DEL**. The values below the deleted cell will scroll up one row.
- To delete a column of data, highlight an entry in that column and press **SHIFT CLEAR**. Select the column name.
- To delete all columns of data, press **SHIFT CLEAR**. Select **All columns**.

## Insert data

Highlight the entry *following* the point of insertion. Press **INS**, then enter a number. It will write over the zero that was inserted.

## Sort data values

1. In Numeric view, highlight the column you want to sort, and press **SORT**.
2. Specify the Sort Order. You can choose either **Ascending** or **Descending**.
3. Specify the **INDEPENDENT** and **DEPENDENT** data columns. Sorting is by the *independent* column. For instance, if **Age** is **C1** and **Income** is **C2** and you want to sort by **Income**, then you make **C2** the independent column for the sorting and **C1** the dependent column.
  - To sort just one column, choose **None** for the dependent column.
  - For one-variable statistics with two data columns, specify the frequency column as the dependent column.
4. Press **OK**.

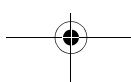
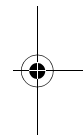
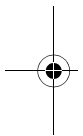

## Defining a regression model

The Symbolic view includes an expression (Fit1 through Fit5) that defines the regression model, or “fit”, to use for the regression analysis of each two-variable data set.

There are three ways to select a regression model:

- Accept the default option to fit the data to a straight line.
- Select one of the available fit options in Symbolic Setup view.
- Enter your own mathematical expression in Symbolic view. This expression will be plotted, *but it will not be fitted to the data points.*

### Angle Setting

You can ignore the angle measurement mode *unless* your Fit definition (in Symbolic view) involves a trigonometric function. In this case, you should specify in the mode screen whether the trigonometric units are to be interpreted in degrees, radians, or grads.

### To choose the fit

1. In Numeric view, make sure **EWRR** is set.
2. Press **[SHIFT]SETUP-SYMB** to display the Symbolic Setup view. Highlight the Fit number (S1FIT to S5FIT) you want to define.
3. Press **[CHOOSE]** and select from the list. Press **[OK]** when done. The regression formula for the fit is displayed in Symbolic view.

### Fit models

Ten fit models are available:

Fit model	Meaning
Linear	(Default.) Fits the data to a straight line, $y = mx + b$ . Uses a least-squares fit.
Logarithmic	Fits to a logarithmic curve, $y = m \ln x + b$ .
Exponential	Fits to an exponential curve, $y = be^{mx}$ .
Power	Fits to a power curve, $y = bx^m$ .



Fit model	Meaning (Continued)
Quadratic	Fits to a quadratic curve, $y = ax^2 + bx + c$ . Needs at least three points.
Cubic	Fits to a cubic curve, $y = ax^3 + bx^2 + cx + d$ . Needs at least four points.
Logistic	Fits to a logistic curve, $y = \frac{L}{1 + ae^{(-bx)}}$ where $L$ is the saturation value for growth. You can store a positive real value in $L$ , or—if $L=0$ —let $L$ be computed automatically.
Exponent	Fits to an exponent curve, $y = ab^x$ .
Trigonometric	Fits to a trigonometric curve, $y = a \cdot \sin(bx + c) + d$ . Needs at least three points.
User Defined	Define your own expression (in Symbolic view.)

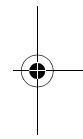
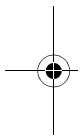

### To define your own fit

1. In Numeric view, make sure **EQNR** is set.
2. Display the Symbolic view.
3. Highlight the Fit expression (Fit1, etc.) for the desired data set.
4. Type in an expression and press **ENTER**.  
The independent variable must be  $X$ , and the expression must not contain any unknown variables.  
Example:  $1.5 \times \cos x + 0.3 \times \sin x$ .

This automatically changes the Fit type (S1FIT, etc.) in the Symbolic Setup view to User Defined.

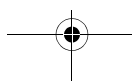



## Computed statistics

### One-variable

Statistic	Definition
$N\Sigma$	Number of data points.
$TOT\Sigma$	Sum of data values (with their frequencies).
$MEAN\Sigma$	Mean value of data set.
$PVAR\Sigma$	Population variance of data set.
$SVAR\Sigma$	Sample variance of data set.
$PSDEV$	Population standard deviation of data set.
$SSDEV$	Sample standard deviation of data set.
$MIN\Sigma$	Minimum data value in data set.
Q1	First quartile: median of values to left of median.
MEDIAN	Median value of data set.
Q3	Third quartile: median of values to right of median.
$MAX\Sigma$	Maximum data value in data set.

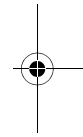
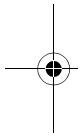

When the data set contains an odd number of values, the data set's median value is not used when calculating Q1 and Q3 in the table above. For example, for the following data set:

{3, 5, 7, 8, 15, 16, 17}

only the first three items, 3, 5, and 7 are used to calculate Q1, and only the last three terms, 15, 16, and 17 are used to calculate Q3.

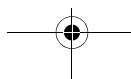

## Two-variable

Statistic	Definition
MEANX	Mean of $x$ - (independent) values.
$\Sigma X$	Sum of $x$ -values.
$\Sigma X^2$	Sum of $x^2$ -values.
MEANY	Mean of $y$ - (dependent) values.
$\Sigma Y$	Sum of $y$ -values.
$\Sigma Y^2$	Sum of $y^2$ -values.
$\Sigma XY$	Sum of each $xy$ .
SCOV	Sample covariance of independent and dependent data columns.
PCOV	Population covariance of independent and dependent data columns
CORR	Correlation coefficient of the independent and dependent data columns <i>for a linear fit only</i> (regardless of the Fit chosen). Returns a value from 0 to 1, where 1 is the best fit.
RELERR	The relative error for the selected fit. Provides a measure of accuracy for the fit.

## Plotting

You can plot:

- histograms (**1URF**)
- box-and-whisker plots (**1URF**)
- scatter plots (**2URF**).

Once you have entered your data (**NUM**), defined your data set (**SYMB**), and defined your Fit model for two-variable statistics (**SHIFT** **SETUP-SYMB**), you can plot your data. You can plot up to five scatter or box-and-whisker plots at a time. You can plot only one histogram at a time.



### To plot statistical data

1. In Symbolic view ( **[SYMB]** ), select ( **[WCHSE]** ) the data sets you want to plot.
2. For one-variable data ( **[DVAR]** ), select the plot type in Plot Setup ( **[SHIFT] SETUP-PLT** ). Highlight STATPLOT, press **[CHOOSE]**, select either Histogram or BoxWhisker, and press **[OK]**.
3. For any plot, but especially for a histogram, adjust the plotting scale and range in the Plot Setup view. If you find histogram bars too fat or too thin, you can adjust them by adjusting the HWIDTH setting.
4. Press **[PLOT]**. If you have not adjusted the Plot Setup yourself, you can try **[VIEWS]** select Auto Scale **[OK]**.

Auto Scale can be relied upon to give a good starting scale which can then be adjusted in the Plot Setup view.

## Plot types

### Histogram

#### One-variable statistics.

The numbers below the plot mean that the current bar (where the cursor is) starts at 0 and ends at 2 (not including 2), and the frequency for this column, (that is, the number of data elements that fall between 0 and 2) is 1. You can see information about the next bar by pressing the **[▶]** key.

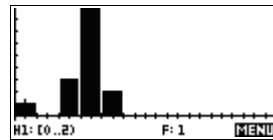

### Box and Whisker Plot

#### One-variable statistics.

The left whisker marks the minimum data value. The box marks the first quartile, the median (where the cursor is), and the third quartile.

The right whisker marks the maximum data value. The numbers below the plot mean that this column has a median of 13.

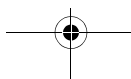
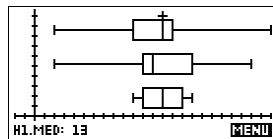



## Scatter Plot

### Two-variable statistics.

The numbers below the plot indicate that the cursor is at the first data point for S2, at (1, 6). Press  to move to the next data point and display information about it.



To connect the data points as they are plotted, checkmark **CONNECT** in the second page of the Plot Setup. *This is not a regression curve.*

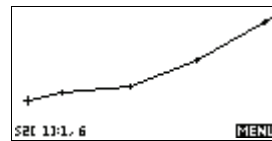

## Fitting a curve to 2VAR data

In the Plot view, press **FIT**. This draws a curve to fit the checked two-variable data set(s). See "To choose the fit" on page 10-12.

**PLOT**  
**MENU**  
**FIT**

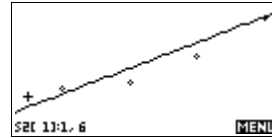

**SYMB**

```

STATISTICS SYMBOLIC VIEW
S1: C1      C2
Fit1: 2.12195121951...
✓S2: C3      C4
✓Fit2: 1.98082191781...
ENTER USER DEFINED FIT
EDIT ✓CHK 8 SHOW EVAL
    
```

**SHOW**

The expression in Fit2 shows that the slope=1.98082191781 and the y-intercept=2.2657.

```

1.98082191781X+2.2657
    
```

## Correlation coefficient

The correlation coefficient is stored in the **CORR** variable. It is a measure of fit to a *linear* curve only. Regardless of the Fit model you have chosen, **CORR** relates to the linear model.



### Relative Error

The relative error is a measure of the error between predicted values and actual values based on the specified Fit. A smaller number means a better fit.

The *relative error* is stored in a variable named RELERR. The relative error provides a measure of fit accuracy for all fits, and it *does* depend on the Fit model you have chosen.

#### HINT

In order to access the CORR and RELERR variables after you plot a set of statistics, you must press [NUM] to access the numeric view and then [STATS] to display the correlation values. The values are stored in the variables when you access the Symbolic view.

## Setting up the plot (Plot setup view)

The Plot Setup view ([SHIFT]SETUP-PLOT) sets most of the same plotting parameters as it does for the other built-in aplets.

See "Setting up the plot (Plot view setup)" on page 2-5. Settings unique to the Statistics aplet are as follows:

### Plot type (1VAR)

STATPLOT enables you to specify either a histogram or a box-and-whisker plot for one-variable statistics (when 1VAR is set). Press [CHOOSE] to change the highlighted setting

### Histogram width

HWIDTH enables you to specify the width of a histogram bar. This determines how many bars will fit in the display, as well as how the data is distributed (how many values each bar represents).

### Histogram range

HRNG enables you to specify the range of values for a set of histogram bars. The range runs from the left edge of the leftmost bar to the right edge of the rightmost bar. You can limit the range to exclude any values you suspect are outliers.

### Plotting mark (2VAR)

S1MARK through S5MARK enables you to specify one of five symbols to use to plot each data set. Press [CHOOSE] to change the highlighted setting.

### Connected points (2VAR)

CONNECT (on the second page), when checkmarked, connects the data points as they are plotted. *The resulting line is not the regression curve.* The order of plotting is according to the ascending order of independent values.

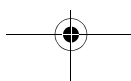



For instance, the data set (1, 1), (3, 9), (4, 16), (2, 4) would be plotted and traced in the order (1, 1), (2, 4), (3, 9), (4, 16).

## Trouble-shooting a plot

If you have problems plotting, check that you have the following:

- The correct **1VAR** or **2VAR** menu label on (Numeric view).
- The correct fit (regression model), if the data set is two-variable.
- Only the data sets to compute or plot are checkmarked (Symbolic view).
- The correct plotting range. Try using **VIEWS** Auto Scale (instead of **PLOT**), or adjust the plotting parameters (in Plot Setup) for the ranges of the axes and the width of histogram bars (**HWIDTH**).

In **2VAR** mode, ensure that both paired columns contain data, and that they are the same length.

In **1VAR** mode, ensure that a paired column of frequency values is the same length as the data column that it refers to.

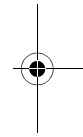
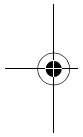

## Exploring the graph

The Plot view has menu keys for zooming, tracing, and coordinate display. There are also scaling options under **VIEWS**. These options are described in "Exploring the graph" on page 2-7.

### Statistics aplet's PLOT view keys

Key	Meaning
<b>SHIFT</b> <b>CLEAR</b>	Erases the plot.
<b>VIEWS</b>	Offers additional pre-defined views for splitting the screen, overlaying plots, and autoscaling the axes.
<b>SHIFT</b> <b>◀</b>	Moves cursor to far left or far right.
<b>SHIFT</b> <b>▶</b>	

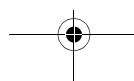

Key	Meaning (Continued)
<b>ZOOM</b>	Displays ZOOM menu.
<b>TRACE</b>	Turns trace mode on/off. The white box appears next to the option when Trace mode is active.
<b>FIT</b>	Turns fit mode on or off. Turning <b>FIT</b> on draws a curve to fit the data points according to the current regression model.
<b>GOTO</b> (2var statistics only)	Enables you to specify a value on the line of best fit to jump to or a data point number to jump to.
<b>DEFN</b>	Displays the equation of the regression curve.
<b>MENU</b>	Hides and displays the menu key labels. When the labels are hidden, any menu key displays the (x,y) coordinates. Pressing <b>MENU</b> redisplayes the menu labels.

## Calculating predicted values

The functions **PREDX** and **PREDY** estimate (predict) values for  $X$  or  $Y$  given a hypothetical value for the other. The estimation is made based on the curve that has been calculated to fit the data according to the specified fit.

### Find predicted values

1. In Plot view, draw the regression curve for the data set.
2. Press **▼** to move to the regression curve.
3. Press **GOTO** and enter the value of  $X$ . The cursor jumps to the specified point on the curve and the coordinate display shows  $X$  and the predicted value of  $Y$ .

In HOME:

- Enter **PREDX(y-value)** **ENTER** to find the predicted value for the independent variable given a hypothetical dependent value.



- Enter  $\text{PREDY}(x\text{-value})$  to find the predicted value of the dependent variable given a hypothetical independent variable.

You can type `PREDX` and `PREDY` into the edit line, or you can copy these function names from the `MATH` menu under the `Stat-Two` category.

**HINT**

---

In cases where more than one fit curve is displayed, the `PREDY` function uses the most recently calculated curve. In order to avoid errors with this function, uncheck all fits except the one that you want to work with, or use the `Plot View` method.

---

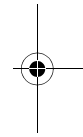
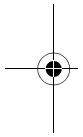

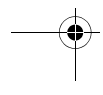
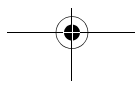
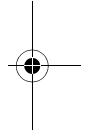
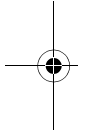
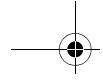



## Inference aplet

### About the Inference aplet

The Inference capabilities include calculation of confidence intervals and hypothesis tests based on the Normal Z-distribution or Student's t-distribution.

Based on the statistics from one or two samples, you can test hypotheses and find confidence intervals for the following quantities:

- mean
- proportion
- difference between two means
- difference between two proportions

### Example data

When you first access an input form for an Inference test, by default, the input form contains example data. This example data is designed to return meaningful results that relate to the test. It is useful for gaining an understanding of what the test does, and for demonstrating the test. The calculator's on-line help provides a description of what the example data represents.

### Getting started with the Inference aplet

This example describes the Inference aplet's options and functionality by stepping you through an example using the example data for the Z-Test on 1 mean.

#### Open the Inference aplet

1. Open the Inference aplet.

**APLET**

Select Inference

**RESET** **YES** **EXIT**

The Inference aplet opens in the Symbolic view.

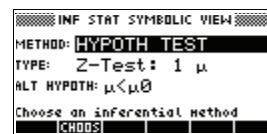

**Inference applet's SYMB view keys**

The table below summarizes the options available in Symbolic view.

<b>Hypothesis Tests</b>	<b>Confidence Intervals</b>
Z: $1 \mu$ , the Z-Test on 1 mean	Z-Int: $1 \mu$ , the confidence interval for 1 mean, based on the Normal distribution
Z: $\mu_1 - \mu_2$ , the Z-Test on the difference of two means	Z-Int: $\mu_1 - \mu_2$ , the confidence interval for the difference of two means, based on the Normal distribution
Z: $1 \pi$ , the Z-Test on 1 proportion	Z-Int: $1 \pi$ , the confidence interval for 1 proportion, based on the Normal distribution
Z: $\pi_1 - \pi_2$ , the Z-Test on the difference in two proportions	Z-Int: $\pi_1 - \pi_2$ , the confidence interval for the difference of two proportions, based on the Normal distribution
T: $1 \mu$ , the T-Test on 1 mean	T-Int: $1 \mu$ , the confidence interval for 1 mean, based on the Student's t-distribution
T: $\mu_1 - \mu_2$ , the T-Test on the difference of two means	T-Int: $\mu_1 - \mu_2$ , the confidence interval for the difference of two means, based on the Student's t-distribution

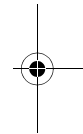
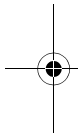

If you choose one of the hypothesis tests, you can choose the alternative hypothesis to test against the null hypothesis. For each test, there are three possible choices for an alternative hypothesis based on a quantitative comparison of two quantities. The null hypothesis is always that the two quantities are equal. Thus, the alternative hypotheses cover the various cases for the two quantities being unequal:  $<$ ,  $>$ , and  $\neq$ .

In this section, we will use the example data for the Z-Test on 1 mean to illustrate how the applet works and what features the various views present.

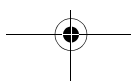



## Select the inferential method

2. Select the Hypothesis Test inferential method.

**CHOOS**  
Select HYPOTH TEST



3. Define the type of test.

**OK**   
**CHOOS**  
Z-Test: 1  $\mu$

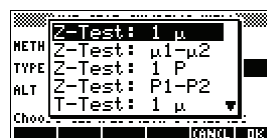

4. Select an alternative hypothesis.

**OK**   
**CHOOS**  
 $\mu < \mu_0$   
**OK**

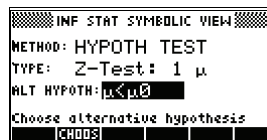

## Enter data

5. Enter the sample statistics and population parameters.

**SHIFT** setup-NUM

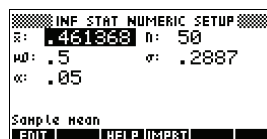



The table below lists the fields in this view for our current Z-Test: 1  $\mu$  example.

Field name	Definition
$\mu_0$	Assumed population mean
$\sigma$	Population standard deviation
$\bar{x}$	Sample mean
n	Sample size
$\alpha$	Alpha level for the test

By default, each field already contains a value. These values constitute the example database and are explained in the  feature of this aplet.

### Display on-line help

- To display the on-line help, press .
- To close the on-line help, press .

```
Tests the null hypothesis that
the population mean is an assumed
value, μ0, against the
alternative hypotheses.

Example data
A set of 50 random numbers from 0
to 1, generated by a calculator,
has a mean of 0.461368. The
[OK]
```

### Display test results in numeric format

- Display the test results in numeric format.



The test distribution value and its associated probability are displayed, along with the critical value(s) of the test and the associated critical value(s) of the statistic.

```
INF STAT NUMERIC VIEW
α=.05
Test Z=-.9462054
Prob=.1720219
Critical Z=-1.644854
Critical α=.4328438
[HELP]
```

*Note: You can access the on-line help in Numeric view.*

### Plot test results

- Display a graphic view of the test results.



Horizontal axes are presented for both the distribution variable and the test statistic. A generic bell curve represents the probability distribution function. Vertical lines mark the critical value(s) of the test, as well as the value of the test statistic. The rejection region is marked  $\leftarrow R$  and the test numeric results are displayed between the horizontal axes.

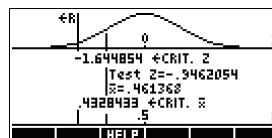

## Importing sample statistics from the Statistics aplet

The Inference aplet supports the calculation of confidence intervals and the testing of hypotheses based on data in the Statistics aplet. Computed statistics for a sample of data in a column in any Statistics-based aplet can be imported for use in the Inference aplet. The following example illustrates the process.

A calculator produces the following 6 random numbers:  
0.529, 0.295, 0.952, 0.259, 0.925, and 0.592

### Open the Statistics aplet

1. Open the Statistics aplet and reset the current settings.

Select  
Statistics

n	C1	C2	C3	C4
1				

EDIT INS SORT BIG 1VAR STATS

The Statistics aplet opens in the Numeric view.

### Enter data

2. In the C1 column, enter the random numbers produced by the calculator.

n	C1	C2	C3	C4
1	.295			
2	.259			
3	.925			
4	.592			
5				
6				

EDIT INS SORT BIG 1VAR STATS

**HINT** If the Decimal Mark setting in the Modes input form ( modes) is set to Comma, use  instead of .

3. If necessary, select 1-variable statistics. Do this by pressing the fifth menu key until  is displayed as its menu label.

### Calculate statistics

4. Calculate statistics.

1-VAR	H1		
NΣ	6		
TOTΣ	3.552		
MEANΣ	.592		
PVARΣ	.023926		
SVARΣ	.088712		
PSDEV	.2718934		
Σ			
			OK

The mean of 0.592 seems a little large compared to the expected value of 0.5. To see if the difference is statistically significant, we will use the statistics computed here to construct a confidence interval for the true mean of the population of random numbers and see whether or not this interval contains 0.5.

5. Press  to close the computed statistics window.

### Open Inference aplet

- Open the Inference aplet and clear current settings.

**APLET** Select  
Inference  
**RESET** **YES**  
**START**

```
INF STAT SYMBOLIC VIEW
METHOD: HYPOTH TEST
TYPE: Z-Test: 1 μ
ALT HYPOTH: μ < μ0
Choose an inferential method
[CHDS]
```

### Select inference method and type

- Select an inference method.

**CHDS**  
Select CONF INTERVAL  
**OK**

```
INF STAT SYMBOLIC VIEW
METHOD: CONF INTERVAL
TYPE: Z-INT: 1 μ
Choose an inferential method
[CHDS]
```

- Select a distribution statistic type.

**CHDS**  
Select T-Int: 1 μ  
**OK**

```
INF STAT SYMBOLIC VIEW
METHOD: CONF INTERVAL
TYPE: T-INT: 1 μ
Choose distribution statistic
[CHDS]
```

### Set up the interval calculation

- Set up the interval calculation. Note: The default values are derived from sample data from the on-line help example.

**SHIFT** Setup-NUM

```
INF STAT NUMERIC SETUP
μ: .461368
σx: .2776
n: 50
c: .99
Sample Mean
[EDIT] [HELP] [IMPRT]
```

## Import the data

10. Import the data from the Statistics aplet. *Note: The data from C1 is displayed by default.*

**IMPORT**

*Note: Press **ON** to see the statistics before importing them into the Numeric Setup view.*

*Also, if there is more than one aplet based on the Statistics aplet, you are prompted to choose one.*



**ON**

11. Specify a 90% confidence interval in the C: field.

**▼ ▼ ▼** to move to the C: field

0.9 **ENTER**

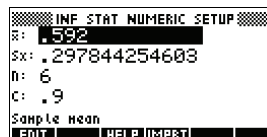
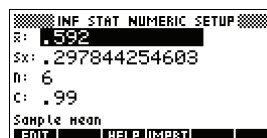

## Display Numeric view

12. Display the confidence interval in the Numeric view. *Note: The interval setting is 0.5.*

**NUM**

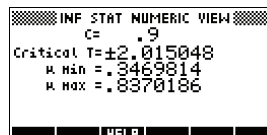

## Display Plot view

13. Display the confidence interval in the Plot view.

**PLOT**

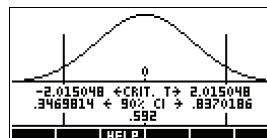

You can see, from the second text row, that the mean is contained within the 90% confidence interval (CI) of 0.3469814 to 0.8370186.

*Note: The graph is a simple, generic bell-curve. It is not meant to accurately represent the t-distribution with 5 degrees of freedom.*



## Hypothesis tests

You use hypothesis tests to test the validity of hypotheses that relate to the statistical parameters of one or two populations. The tests are based on statistics of samples of the populations.

The HP 40gs hypothesis tests use the Normal Z-distribution or Student's t-distribution to calculate probabilities.

## One-Sample Z-Test

### Menu name

Z-Test: 1  $\mu$

On the basis of statistics from a single sample, the One-Sample Z-Test measures the strength of the evidence for a selected hypothesis against the null hypothesis. The null hypothesis is that the population mean equals a specified value  $H_0: \mu = \mu_0$ .

You select one of the following alternative hypotheses against which to test the null hypothesis:

$$H_1: \mu_1 < \mu_2$$

$$H_1: \mu_1 > \mu_2$$

$$H_1: \mu_1 \neq \mu_2$$

### Inputs

The inputs are:

Field name	Definition
$\bar{x}$	Sample mean.
n	Sample size.
$\mu_0$	Hypothetical population mean.
$\sigma$	Population standard deviation.
$\alpha$	Significance level.

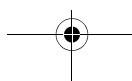
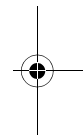
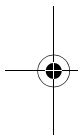

**Results**

The results are:

Result	Description
Test Z	Z-test statistic.
Prob	Probability associated with the Z-Test statistic.
Critical Z	Boundary values of Z associated with the $\alpha$ level that you supplied.
Critical $\bar{x}$	Boundary values of $\bar{x}$ required by the $\alpha$ value that you supplied.

**Two-Sample Z-Test****Menu name**Z-Test:  $\mu_1 - \mu_2$ 

On the basis of two samples, each from a separate population, this test measures the strength of the evidence for a selected hypothesis against the null hypothesis. The null hypothesis is that the mean of the two populations are equal ( $H_0: \mu_1 = \mu_2$ ).

You select one of the following alternative hypotheses against which to test the null hypothesis:

$$H_1: \mu_1 < \mu_2$$

$$H_1: \mu_1 > \mu_2$$

$$H_1: \mu_1 \neq \mu_2$$

**Inputs**

The inputs are:

Field name	Definition
$\bar{x}_1$	Sample 1 mean.
$\bar{x}_2$	Sample 2 mean.
n1	Sample 1 size.
n2	Sample 2 size.
$\sigma_1$	Population 1 standard deviation.

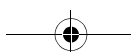



Field name	Definition
$\sigma_2$	Population 2 standard deviation.
$\alpha$	Significance level.

**Results**

The results are:

Result	Description
Test Z	Z-Test statistic.
Prob	Probability associated with the Z-Test statistic.
Critical Z	Boundary value of Z associated with the $\alpha$ level that you supplied.

**One-Proportion Z-Test****Menu name**Z-Test:  $1\pi$ 

On the basis of statistics from a single sample, this test measures the strength of the evidence for a selected hypothesis against the null hypothesis. The null hypothesis is that the proportion of successes in the two populations is equal:  $H_0: \pi = \pi_0$

You select one of the following alternative hypotheses against which to test the null hypothesis:

$$H_1: \pi < \pi_0$$

$$H_1: \pi > \pi_0$$

$$H_1: \pi \neq \pi_0$$

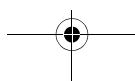
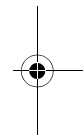
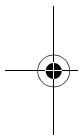



**Inputs**

The inputs are:

Field name	Definition
x	Number of successes in the sample.
n	Sample size.
$\pi_0$	Population proportion of successes.
$\alpha$	Significance level.

**Results**

The results are:

Result	Description
Test P	Proportion of successes in the sample.
Test Z	Z-Test statistic.
Prob	Probability associated with the Z-Test statistic.
Critical Z	Boundary value of Z associated with the level you supplied.

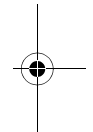
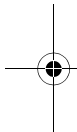
**Two-Proportion Z-Test****Menu name**Z-Test:  $\pi_1 - \pi_2$ 

On the basis of statistics from two samples, each from a different population, the Two-Proportion Z-Test measures the strength of the evidence for a selected hypothesis against the null hypothesis. The null hypothesis is that the proportion of successes in the two populations is equal  $H_0: \pi_1 = \pi_2$ .

You select one of the following alternative hypotheses against which to test the null hypothesis:

$$H_1: \pi_1 < \pi_2$$

$$H_1: \pi_1 > \pi_2$$

$$H_1: \pi_1 \neq \pi_2$$

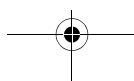

**Inputs**

The inputs are:

Field name	Definition
x1	Sample 1 mean.
x2	Sample 2 mean.
n1	Sample 1 size.
n2	Sample 2 size.
$\alpha$	Significance level.

**Results**

The results are:

Result	Description
Test $\pi_1 - \pi_2$	Difference between the proportions of successes in the two samples.
Test Z	Z-Test statistic.
Prob	Probability associated with the Z-Test statistic.
Critical Z	Boundary values of Z associated with the $\alpha$ level that you supplied.

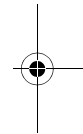
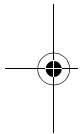
**One-Sample T-Test****Menu name**T-Test: 1  $\mu$ 

The One-sample T-Test is used when the population standard deviation is not known. On the basis of statistics from a single sample, this test measures the strength of the evidence for a selected hypothesis against the null hypothesis. The null hypothesis is that the sample mean has some assumed value,

$$H_0: \mu = \mu_0$$

You select one of the following alternative hypotheses against which to test the null hypothesis:

$$H_1: \mu < \mu_0$$

$$H_1: \mu > \mu_0$$

$$H_1: \mu \neq \mu_0$$

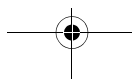



### Inputs

The inputs are:

Field name	Definition
$\bar{x}$	Sample mean.
Sx	Sample standard deviation.
n	Sample size.
$\mu_0$	Hypothetical population mean.
$\alpha$	Significance level.

### Results

The results are:

Result	Description
Test T	T-Test statistic.
Prob	Probability associated with the T-Test statistic.
Critical T	Boundary value of T associated with the $\alpha$ level that you supplied.
Critical $\bar{x}$	Boundary value of $\bar{x}$ required by the $\alpha$ value that you supplied.

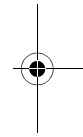
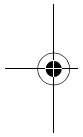



## Two-Sample T-Test

### Menu name

T-Test:  $\mu_1 - \mu_2$

The Two-sample T-Test is used when the population standard deviation is not known. On the basis of statistics from two samples, each sample from a different population, this test measures the strength of the evidence for a selected hypothesis against the null hypothesis. The null hypothesis is that the two populations means are equal  $H_0: \mu_1 = \mu_2$ .

You select one of the following alternative hypotheses against which to test the null hypothesis

$$H_1: \mu_1 < \mu_2$$

$$H_1: \mu_1 > \mu_2$$

$$H_1: \mu_1 \neq \mu_2$$

### Inputs

The inputs are:

Field name	Definition
$\bar{x}_1$	Sample 1 mean.
$\bar{x}_2$	Sample 2 mean.
S1	Sample 1 standard deviation.
S2	Sample 2 standard deviation.
n1	Sample 1 size.
n2	Sample 2 size.
$\alpha$	Significance level.
_Pooled?	Check this option to pool samples based on their standard deviations.

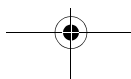
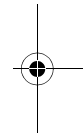
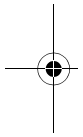

**Results**

The results are:

Result	Description
Test T	T-Test statistic.
Prob	Probability associated with the T-Test statistic.
Critical T	Boundary values of T associated with the $\alpha$ level that you supplied.

**Confidence intervals**

The confidence interval calculations that the HP 40gs can perform are based on the Normal Z-distribution or Student's t-distribution.

**One-Sample Z-Interval****Menu name**Z-INT:  $\mu$  1

This option uses the Normal Z-distribution to calculate a confidence interval for  $m$ , the true mean of a population, when the true population standard deviation,  $s$ , is known.

**Inputs**

The inputs are:

Field name	Definition
$\bar{x}$	Sample mean.
$\sigma$	Population standard deviation.
$n$	Sample size.
$C$	Confidence level.

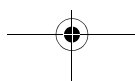
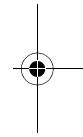
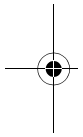

**Results**

The results are:

Result	Description
Critical Z	Critical value for Z.
$\mu$ min	Lower bound for $\mu$ .
$\mu$ max	Upper bound for $\mu$ .

**Two-Sample Z-Interval****Menu name**Z-INT:  $\mu_1 - \mu_2$ 

This option uses the Normal Z-distribution to calculate a confidence interval for the difference between the means of two populations,  $\mu_1 - \mu_2$ , when the population standard deviations,  $\sigma_1$  and  $\sigma_2$ , are known.

**Inputs**

The inputs are:

Field name	Definition
$\bar{x}_1$	Sample 1 mean.
$\bar{x}_2$	Sample 2 mean.
n1	Sample 1 size.
n2	Sample 2 size.
$\sigma_1$	Population 1 standard deviation.
$\sigma_2$	Population 2 standard deviation.
c	Confidence level.

**Results**

The results are:

Result	Description
Critical Z	Critical value for Z.
$\Delta \mu$ Min	Lower bound for $\mu_1 - \mu_2$ .
$\Delta \mu$ Max	Upper bound for $\mu_1 - \mu_2$ .

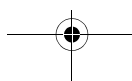



## One-Proportion Z-Interval

**Menu name**Z-INT: 1  $\pi$ 

This option uses the Normal Z-distribution to calculate a confidence interval for the proportion of successes in a population for the case in which a sample of size,  $n$ , has a number of successes,  $x$ .

**Inputs**

The inputs are:

Field name	Definition
$x$	Sample success count.
$n$	Sample size.
$C$	Confidence level.

**Results**

The results are:

Result	Description
Critical Z	Critical value for Z.
$\pi$ Min	Lower bound for $\pi$ .
$\pi$ Max	Upper bound for $\pi$ .

## Two-Proportion Z-Interval

**Menu name**Z-INT:  $\pi_1 - \pi_2$ 

This option uses the Normal Z-distribution to calculate a confidence interval for the difference between the proportions of successes in two populations.

**Inputs**

The inputs are:

Field name	Definition
$\bar{x}_1$	Sample 1 success count.
$\bar{x}_2$	Sample 2 success count.

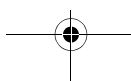



Field name	Definition (Continued)
n1	Sample 1 size.
n2	Sample 2 size.
c	Confidence level.

**Results**

The results are:

Result	Description
Critical Z	Critical value for Z.
$\Delta \pi$ Min	Lower bound for the difference between the proportions of successes.
$\Delta \pi$ Max	Upper bound for the difference between the proportions of successes.

**One-Sample T-Interval****Menu name**T-INT: 1  $\mu$ 

This option uses the Student's t-distribution to calculate a confidence interval for  $m$ , the true mean of a population, for the case in which the true population standard deviation,  $s$ , is unknown.

**Inputs**

The inputs are:

Field name	Definition
$\bar{x}1$	Sample mean.
Sx	Sample standard deviation.
n	Sample size.
c	Confidence level.

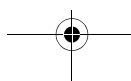



**Results**

The results are:

Result	Description
Critical T	Critical value for T.
$\mu$ Min	Lower bound for $\mu$ .
$\mu$ Max	Upper bound for $\mu$ .

**Two-Sample T-Interval****Menu name**T-INT:  $\mu_1 - \mu_2$ 

This option uses the Student's t-distribution to calculate a confidence interval for the difference between the means of two populations,  $\mu_1 - \mu_2$ , when the population standard deviations,  $s_1$  and  $s_2$ , are unknown.

**Inputs**

The inputs are:

Field name	Definition
$\bar{x}_1$	Sample 1 mean.
$\bar{x}_2$	Sample 2 mean.
$s_1$	Sample 1 standard deviation.
$s_2$	Sample 2 standard deviation.
$n_1$	Sample 1 size.
$n_2$	Sample 2 size.
C	Confidence level.
_Pooled	Whether or not to pool the samples based on their standard deviations.

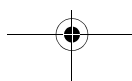
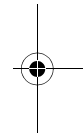
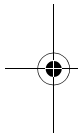

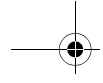

## Results

The results are:

Result	Description
Critical T	Critical value for T.
$\Delta \mu$ Min	Lower bound for $\mu_1 - \mu_2$ .
$\Delta \mu$ Max	Upper bound for $\mu_1 - \mu_2$ .

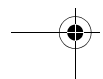
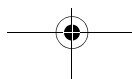
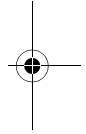
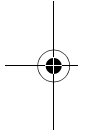

## 12

## Using the Finance Solver

The Finance Solver, or *Finance aplet*, is available by using the APLET key in your calculator. Use the up and down arrow keys to select the *Finance* aplet. Your screen should look as follows:



Press the **ENTER** key or the **APLET** soft menu key to activate the aplet. The resulting screen shows the different elements involved in the solution of financial problems with your HP 40gs calculator.

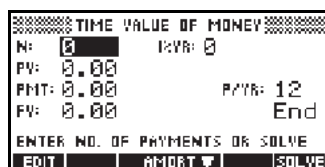

Background information on and applications of financial calculations are provided next.

## Background

The Finance Solver application provides you with the ability of solving time-value-of-money (TVM) and amortization problems. These problems can be used for calculations involving compound interest applications as well as amortization tables.

Compound interest is the process by which earned interest on a given principal amount is added to the principal at specified compounding periods, and then the

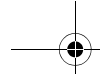

combined amount earns interest at a certain rate. Financial calculations involving compound interest include savings accounts, mortgages, pension funds, leases, and annuities.

Time Value of Money (TVM) calculations, as the name implies, make use of the notion that a dollar today will be worth more than a dollar sometime in the future. A dollar today can be invested at a certain interest rate and generate a return that the same dollar in the future cannot. This TVM principle underlies the notion of interest rates, compound interest and rates of return.

TVM transactions can be represented by using *cash flow diagrams*. A cash flow diagram is a time line divided into equal segments representing the compounding periods. Arrows represent the cash flows, which could be positive (upward arrows) or negative (downward arrows), depending on the point of view of the lender or borrower. The following cash flow diagram shows a loan from a *borrower's* point of view:

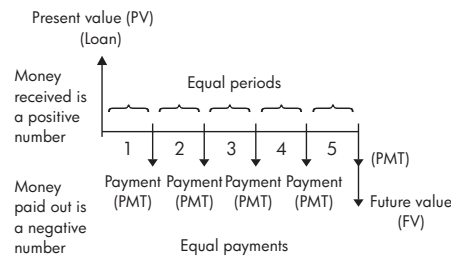

On the other hand, the following cash flow diagram shows a load from the *lender's* point of view:

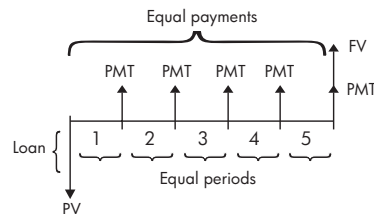

In addition, cash flow diagrams specify *when* payments occur relative to the compounding periods: at the *beginning* of each period or at the *end*. The Finance Solver application provides both of these payment modes: Begin mode and End mode. The following cash

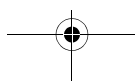



flow diagram shows lease payments at the *beginning* of each period.

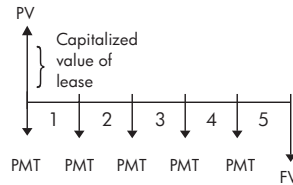

The following cash flow diagram shows deposits into an account at the *end* of each period.

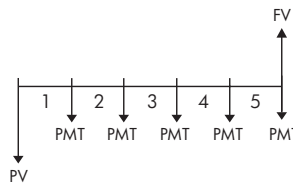

As these cash-flow diagrams imply, there are five TVM variables:

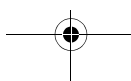

N	The total number of compounding periods or payments.
I%YR	The nominal annual interest rate (or investment rate). This rate is divided by the number of payments per year (P/YR) to compute the nominal interest rate <i>per compounding period</i> - which is the interest rate actually used in TVM calculations.
PV	The present value of the initial cash flow. To a lender or borrower, PV is the amount of the loan; to an investor, PV is the initial investment. PV always occurs at the beginning of the first period.





PMT	The periodic payment amount. The payments are the same amount each period and the TVM calculation assumes that no payments are skipped. Payments can occur at the beginning or the end of each compounding period – an option you control by setting the Payment mode to Beg or End.
FV	The future value of the transaction: the amount of the final cash flow or the compounded value of the series of previous cash flows. For a loan, this is the size of the final balloon payment (beyond any regular payment due). For an investment this is the cash value of an investment at the end of the investment period.

## Performing TVM calculations

1. Launch the Financial Solver as indicated at the beginning of this section.
2. Use the arrow keys to highlight the different fields and enter the known variables in the TVM calculations, pressing the  soft-menu key after entering each known value. Be sure that values are entered for at least four of the five TVM variables (namely, N, I%YR, PV, PMT, and FV).
3. If necessary, enter a different value for P/YR (default value is 12, i.e., monthly payments).
4. Press the key  to change the Payment mode (Beg or End) as required.
5. Use the arrow keys to highlight the TVM variable you wish to solve for and press the  soft-menu key.

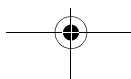
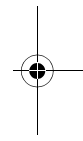
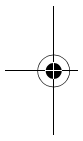

### Example 1 - Loan calculations

Suppose you finance the purchase of a car with a 5-year loan at 5.5% annual interest, compounded monthly. The purchase price of the car is \$19,500, and the down payment is \$3,000. What are the required monthly payments? What is the largest loan you can afford if your maximum monthly payment is \$300? Assume that the payments start at the end of the first period.

Solution. The following cash flow diagram illustrates the loan calculations:

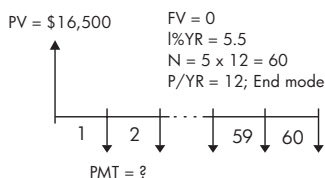

Start the Finance Solver, selecting P/YR = 12 and End payment option.

- Enter the known TVM variables as shown in the diagram above. Your input form should look as follows:



- Highlighting the PMT field, press the **SOLVE** soft menu key to obtain a payment of -315.17 (i.e., PMT = -\$315.17).
- To determine the maximum loan possible if the monthly payments are only \$300, type the value -300 in the PMT field, highlight the PV field, and press the **SOLVE** soft menu key. The resulting value is PV = \$15,705.85.



### Example 2 - Mortgage with balloon payment

Suppose you have taken out a 30-year, \$150,000 house mortgage at 6.5% annual interest. You expect to sell the house in 10 years, repaying the loan in a balloon payment. Find the size of the balloon payment, the value of the mortgage after 10 years of payment.

Solution. The following cash flow diagram illustrates the case of the mortgage with balloon payment:

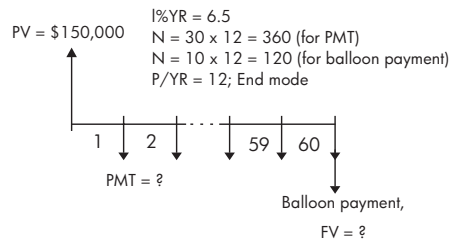

- Start the Finance Solver, selecting P/YR = 12 and End payment option.
- Enter the known TVM variables as shown in the diagram above. Your input form, for calculating monthly payments for the 30-yr mortgage, should look as follows:

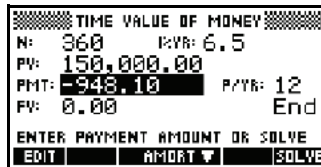

- Highlighting the PMT field, press the **SOLVE** soft menu key to obtain a payment of -948.10 (i.e., PMT = -\$948.10)
- To determine the balloon payment or future value (FV) for the mortgage after 10 years, use N = 120, highlight the FV field, and press the **SOLVE** soft menu key. The resulting value is FV = -\$127,164.19. The negative value indicates a payment from the homeowner. Check that the required balloon payments at the end of 20 years (N=240) and 25 years (N = 300) are -\$83,497.92 and -\$48,456.24, respectively.

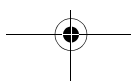



## Calculating Amortizations

Amortization calculations, which also use the TVM variables, determine the amounts applied towards principal and interest in a payment or series of payments.

### To calculate amortizations:

1. Start the Finance Solver as indicated at the beginning of this section.
2. Set the following TVM variables:
  - a Number of payments per year (P/YR)
  - b Payment at beginning or end of periods
3. Store values for the TVM variables I%YR, PV, PMT, and FV, which define the payment schedule.
4. Press the **AMORT** soft menu key and enter the number of payments to amortize in this batch.
5. Press the **AMOR** soft menu key to amortize a batch of payments. The calculator will provide for you the amount applied to interest, to principal, and the remaining balance after this set of payments have been amortized.

### Example 3 - Amortization for home mortgage

For the data of Example 2 above, find the amortization of the loan after the first 10 years ( $12 \times 10 = 120$  payments). Pressing the **AMORT** soft menu key produces the screen to the left. Enter 120 in the PAYMENTS field, and press the **AMOR** soft menu key to produce the results shown to the right.

<pre> AMORTIZE PAYMENTS: 12 PRINCIPAL: INTEREST: BALANCE: ENTER NO. OF PAYMENTS TO AMORT EDIT  TVM  [2ND] AMOR           </pre>	<pre> AMORTIZE PAYMENTS: 120 PRINCIPAL: -22,885.81 INTEREST: -90,936.43 BALANCE: 127,164.19 EDIT  TVM  [2ND] AMOR           </pre>
---	--

### To continue amortizing the loan:

1. Press the **STO PV** soft menu key to store the new balance after the previous amortization as PV.
2. Enter the number of payments to amortize in the new batch.



3. Press the **AMORT** soft menu key to amortize the new batch of payments. Repeat steps 1 through 3 as often as needed.

#### Example 4 - Amortization for home mortgage

For the results of Example 3, show the amortization of the next 10 years of the mortgage loan. First, press the **B→PV** soft menu key. Then, keeping 120 in the PAYMENTS field, press the **AMORT** soft menu key to produce the results shown below.

AMORTIZE	
PAYMENTS:	120
PRINCIPAL:	-48,666.27
INTEREST:	-70,105.98
BALANCE:	83,497.92
EDIT TVM B→PV AMORT	

#### To amortize a series of future payments starting at payment $p$ :

1. Calculate the balance of the loan at payment  $p-1$ .
2. Store the new balance in PV using the **B→PV** soft menu key.
3. Amortize the series of payments starting at the new PV.

The amortization operation reads the values from the TVM variables, rounds the numbers it gets from PV and PMT to the current display mode, then calculates the amortization rounded to the same setting. The original variables are not changed, except for PV, which is updated after each amortization.

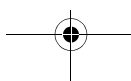
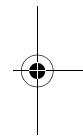
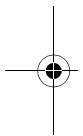



# 13

## Using mathematical functions

---

### Math functions

The HP 40gs contains many math functions. The functions are grouped in categories. For example, the Matrix category contains functions for manipulating matrices. The Probability category (shown as `PRob.` on the MATH menu) contains functions for working with probability.

To use a math function in HOME view, you enter the function onto the command line, and include the arguments in parentheses after the function. You can also select a math function from the MATH menu.

Note that this chapter covers only the use of mathematical functions in HOME view. The use of mathematical functions in CAS is described in Chapter 14, "Computer Algebra System (CAS)".

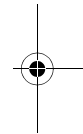
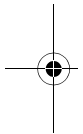

### The MATH menu

The MATH menu provides access to math functions, physical constants, and programming constants. You can also access CAS commands.

The MATH menu is organized by *category*. For each category of functions on the left, there is a list of function names on the right. The highlighted category is the current category.

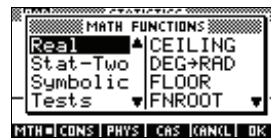

- When you press `MATH`, you see the menu list of Math categories in the left column and the corresponding functions of the highlighted category in the right column. The menu key `MATH` indicates that the MATH FUNCTIONS menu list is active.

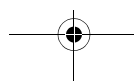

**To select a function**

1. Press  $\boxed{\text{MATH}}$  to display the MATH menu. The categories appear in alphabetical order.
2. Press  $\blacktriangledown$  or  $\blacktriangle$  to scroll through the categories. To jump directly to a category, press the first letter of the category's name. *Note: You do not need to press  $\boxed{\text{ALPHA}}$  first.*
3. The list of functions (on the right) applies to the currently highlighted category (on the left). Use  $\blacktriangleright$  and  $\blacktriangleleft$  to switch between the category list and the function list.
4. Highlight the name of the function you want and press  $\boxed{\text{ENTER}}$ . This copies the function name (and an initial parenthesis, if appropriate) to the edit line.

**NOTE**

If you press  $\boxed{\text{2ND}} \boxed{\text{MATH}}$  while the MATH menu is open, CAS functions and commands are displayed. You can select a CAS function or command in the same way that you select a function from the MATH menu (by pressing the arrow keys and then  $\boxed{\text{ENTER}}$ ). The function or command selected appears on the edit line in HOME (and with an initial parenthesis, if appropriate).

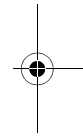
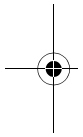
**Function categories (MATH menu)**

- Calculus
- Complex numbers
- Constant
- Convert
- Hyperbolic trigonometry (Hyperb.)
- Lists
- Loop
- Matrix
- Polynomial
- Probability
- Real numbers (Real)
- Two-variable statistics (Stat-Two)
- Symbolic
- Tests
- Trigonometry (Trig)

**Math functions by category****Syntax**

Each function's definition includes its syntax, that is, the exact order and spelling of a function's name, its delimiters (punctuation), and its arguments. Note that the syntax for a function does not require spaces.

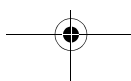



## Functions common to keyboard and menus

These functions are common to the keyboard and MATH menu.

**SHIFT**  $\pi$

For a description, see “ $\pi$ ” on page 13-8.

**SHIFT** *ARG*

For a description, see “*ARG*” on page 13-7.

**d/dx**

For a description, see “ $\partial$ ” on page 11-7.

**SHIFT** *AND*

For a description, see “*AND*” on page 13-19.

**SHIFT** !

For a description, see “*COMB*(5,2) returns 10. That is, there are ten different ways that five things can be combined two at a time.!” on page 13-12.

**SHIFT**  $\Sigma$

For a description, see “*S*” on page 13-11.

**SHIFT** *EEX*

For a description, see “Scientific notation (powers of 10)” on page 1-20.

**SHIFT**  $\int$

For a description, see “ $\int$ ” on page 11-7.

**SHIFT**  $x^{-1}$

The multiplicative inverse function finds the inverse of a square matrix, and the multiplicative inverse of a real or complex number. Also works on a list containing only these object types.

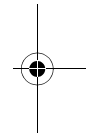
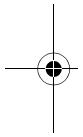

## Keyboard functions

The most frequently used functions are available directly from the keyboard. Many of the keyboard functions also accept complex numbers as arguments.

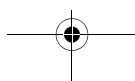



**[+], [-], [x], [=]**

Add, Subtract, Multiply, Divide. Also accepts complex numbers, lists and matrices.  
 $value1 + value2$ , etc.

**[SHIFT]  $e^x$**

Natural exponential. Also accepts complex numbers.  
 $e^{value}$

**Example**

$e^5$  returns 148.413159103

**[ln]**

Natural logarithm. Also accepts complex numbers.  
 $LN(value)$

**Example**

$LN(1)$  returns 0

**[SHIFT]  $10^x$**

Exponential (antilogarithm). Also accepts complex numbers.

$10^{value}$

**Example**

$10^3$  returns 1000

**[log]**

Common logarithm. Also accepts complex numbers.  
 $LOG(value)$

**Example**

$LOG(100)$  returns 2

**[SIN], [COS], [TAN]**

Sine, cosine, tangent. Inputs and outputs depend on the current angle format (Degrees, Radians, or Grads).

$SIN(value)$   
 $COS(value)$   
 $TAN(value)$

**Example**

$TAN(45)$  returns 1 (Degrees mode).

**[SHIFT]  $ASIN$**

Arc sine:  $\sin^{-1}x$ . Output range is from  $-90^\circ$  to  $90^\circ$ ,  $-\pi/2$  to  $\pi/2$ , or  $-100$  to  $100$  grads. Inputs and outputs depend on the current angle format. Also accepts complex numbers.

$ASIN(value)$

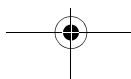
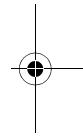
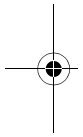

**Example**

ASIN(1) returns 90 (Degrees mode).

 ACOS

Arc cosine:  $\cos^{-1}x$ . Output range is from  $0^\circ$  to  $180^\circ$ , 0 to  $\pi$ , or 0 to 200 grads. Inputs and outputs depend on the current angle format. Also accepts complex numbers. Output will be complex for values outside the normal COS domain of  $-1 \leq x \leq 1$ .

ACOS(*value*)

**Example**

ACOS(1) returns 0 (Degrees mode).

 ATAN

Arc tangent:  $\tan^{-1}x$ . Output range is from  $-90^\circ$  to  $90^\circ$ ,  $2\pi/2$  to  $\pi/2$ , or  $-100$  to  $100$  grads. Inputs and outputs depend on the current angle format. Also accepts complex numbers.

ATAN(*value*)

**Example**

ATAN(1) returns 45 (Degrees mode).



Square. Also accepts complex numbers.

*value*<sup>2</sup>

**Example**

$18^2$  returns 324

Square root. Also accepts complex numbers.

$\sqrt{\text{value}}$

**Example**

$\sqrt{324}$  returns 18



Negation. Also accepts complex numbers.

-*value*

**Example**

-(1,2) returns (-1,-2)



Power (*x* raised to *y*). Also accepts complex numbers.

*value*<sup>*power*</sup>

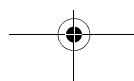
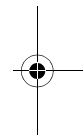
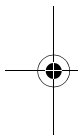

**Example**

$2^8$  returns 256

**SHIFT** ABS

Absolute value. For a complex number, this is  $\sqrt{x^2+y^2}$ .

ABS(*value*)

ABS(*x*, *y*)

**Example**

ABS(-1) returns 1

ABS(1, 2) returns 2.2360679775

**SHIFT**  $\sqrt[n]{\phantom{x}}$

Takes the *n*th root of *x*.

*root* NTHROOT *value*

**Example**

3 NTHROOT 8 returns 2

**Calculus functions**

The symbols for differentiation and integration are available directly from the keyboard—**d/dx** and **S** respectively—as well as from the MATH menu.

$\partial$

Differentiates *expression* with respect to the *variable* of differentiation. From the command line, use a formal name (S1, etc.) for a non-numeric result. See “Finding derivatives” on page 13-21.

$\partial$  *variable*(*expression*)

**Example**

$\partial$  s1 (s1<sup>2</sup>+3\*s1) returns 2\*s1+3

$\int$

Integrates *expression* from *lower* to *upper* limits with respect to the *variable* of integration. To find the definite integral, both limits must have numeric values (that is, be numbers or real variables). To find the indefinite integral, one of the limits must be a formal variable (s1, etc).

$\int$  (*lower*, *upper*, *expression*, *variable*)

See “Using formal variables” on page 13-20 for further details.



**Example**

$\int (0, s1, 2 * X + 3, X)$  **ENTER** **▲** **COPY** **ENTER**  
 finds the indefinite result  $3 * s1 + 2 * (s1^2 / 2)$

See "To find the indefinite integral using formal variables" on page 13-23 for more information on finding indefinite integrals.

**TAYLOR**

Calculates the  $n$ th order Taylor polynomial of *expression* at the point where the given *variable* = 0.

TAYLOR (*expression*, *variable*,  $n$ )

**Example**

TAYLOR( $1 + \sin(s1)^2$ ,  $s1$ , 5) with Radians angle measure and Fraction number format (set in MODES) returns  $1 + s1^2 + (1/3) * s1^4$ .

**Complex number functions**

These functions are for complex numbers only. You can also use complex numbers with all trigonometric and hyperbolic functions, and with some real-number and keyboard functions. Enter complex numbers in the form  $(x,y)$ , where  $x$  is the real part and  $y$  is the imaginary part.

**ARG**

Argument. Finds the angle defined by a complex number. Inputs and outputs use the current angle format set in Modes.

ARG( $(x, y)$ )

**Example**

ARG( $(3, 3)$ ) returns 45 (Degrees mode)

**CONJ**

Complex conjugate. Conjugation is the negation (sign reversal) of the imaginary part of a complex number.

CONJ( $(x, y)$ )

**Example**

CONJ( $(3, 4)$ ) returns  $(3, -4)$

**IM**

Imaginary part,  $y$ , of a complex number,  $(x, y)$ .

IM( $(x, y)$ )

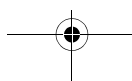
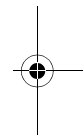
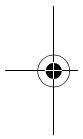



**Example**

$IM((3, 4))$  returns 4

**RE**

Real part  $x$ , of a complex number,  $(x, y)$ .

$RE((x, y))$

**Example**

$RE((3, 4))$  returns 3

**Constants**

The constants available from the MATH FUNCTIONS menu are mathematical constants. These are described in this section. The HP 40gs has two other menus of constants: program constants and physical constants. These are described in "Program constants and physical constants" on page 13-24.

**e**

Natural logarithm base. Internally represented as 2.71828182846.

e

**i**

Imaginary value for  $\sqrt{-1}$ , the complex number (0,1).

i

**MAXREAL**

Maximum real number. Internally represented as  $9.9999999999 \times 10^{499}$ .

MAXREAL

**MINREAL**

Minimum real number. Internally represented as  $1 \times 10^{-499}$ .

MINREAL

**$\pi$**

Internally represented as 3.14159265359.

$\pi$

**Conversions**

The conversion functions are found on the **Convert** menu. They enable you to make the following conversions.

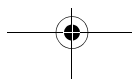
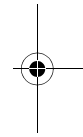
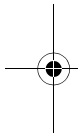

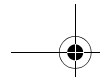

→**C** Convert from Fahrenheit to Celcius.

**Example**

→C(212) returns 100

→**F** Convert from Celcius to Fahrenheit.

**Example**

→F(0) returns 32

→**CM** Convert from inches to centimeters.

→**IN** Convert from centimeters to inches.

→**L** Convert from US gallons to liters.

→**LGAL** Convert from liters to US gallons.

→**KG** Convert from pounds to kilograms.

→**LBS** Convert from kilograms to pounds.

→**KM** Convert from miles to kilometers.

→**MILE** Convert from kilometers to miles.

→**DEG** Convert from radians to degrees.

→**RAD** Convert from degrees to radians.

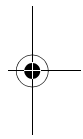
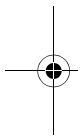

## Hyperbolic trigonometry

The hyperbolic trigonometry functions can also take complex numbers as arguments.

**ACOSH** Inverse hyperbolic cosine :  $\cosh^{-1}x$ .

ACOSH(*value*)

**ASINH** Inverse hyperbolic sine :  $\sinh^{-1}x$ .

ASINH(*value*)

**ATANH** Inverse hyperbolic tangent :  $\tanh^{-1}x$ .

ATANH(*value*)

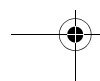
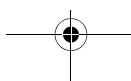

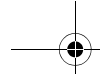
**COSH**

Hyperbolic cosine

COSH(*value*)**SINH**

Hyperbolic sine.

SINH(*value*)**TANH**

Hyperbolic tangent.

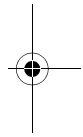
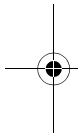
TANH(*value*)**ALOG**Antilogarithm (exponential). This is more accurate than  $10^x$  due to limitations of the power function.ALOG(*value*)**EXP**Natural exponential. This is more accurate than  $e^x$  due to limitations of the power function.EXP(*value*)**EXPM1**Exponent minus 1 :  $e^x - 1$ . This is more accurate than EXP when  $x$  is close to zero.EXPM1(*value*)**LNP1**Natural log plus 1 :  $\ln(x+1)$ . This is more accurate than the natural logarithm function when  $x$  is close to zero.LNP1(*value*)**List functions**

These functions work on list data. See "List functions" on page 19-6.

**Loop functions**

The loop functions display a result after evaluating an expression a given number of times.

**ITERATE**

Repeatedly for *#times* evaluates an *expression* in terms of *variable*. The value for *variable* is updated each time, starting with *initialvalue*.

ITERATE (*expression*, *variable*, *initialvalue*,  
*#times*)

**Example**

ITERATE ( $X^2$ , X, 2, 3) returns 256

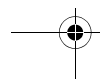
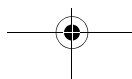

**RECURSE**

Provides a method of defining a sequence without using the Symbolic view of the Sequence applet. If used with | ("where"), RECURSE will step through the evaluation.

RECURSE (*sequencename*, *term<sub>n</sub>*, *term<sub>1</sub>*, *term<sub>2</sub>*)

**Example**

RECURSE (U, U (N-1) \*N, 1, 2) **STO►** U1 (N)  
Stores a factorial-calculating function named U1.

When you enter U1 (5), for example, the function calculates 5! (120).

**Σ**

Summation. Finds the sum of *expression* with respect to *variable* from *initialvalue* to *finalvalue*.

Σ (*variable=initialvalue*, *finalvalue*, *expression*)

**Example**

Σ (C=1, 5, C<sup>2</sup>) returns 55.

**Matrix functions**

These functions are for matrix data stored in matrix variables. See "Matrix functions and commands" on page 18-10.

**Polynomial functions**

Polynomials are products of constants (*coefficients*) and variables raised to powers (*terms*).

**POLYCOEF**

Polynomial coefficients. Returns the coefficients of the polynomial with the specified *roots*.

POLYCOEF ([*roots*])

**Example**

To find the polynomial with roots 2, -3, 4, -5:  
POLYCOEF ([2, -3, 4, -5]) returns [1, 2, -25, -26, 120], representing  $x^4 + 2x^3 - 25x^2 - 26x + 120$ .

**POLYEVAL**

Polynomial evaluation. Evaluates a polynomial with the specified *coefficients* for the *value* of *x*.

POLYEVAL ([*coefficients*], *value*)

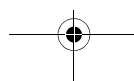
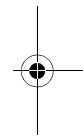
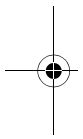

**Example**For  $x^4+2x^3-25x^2-26x+120$ :POLYEQN([1, 2, -25, -26, 120], 8) returns  
3432.**POLYFORM**Polynomial form. Creates a polynomial in *variable1* from *expression*.POLYFORM(*expression*, *variable1*)**Example**POLYFORM((X+1)^2+1, X) returns  $X^2+2X+2$ .**POLYROOT**Polynomial roots. Returns the roots for the *n*th-order polynomial with the specified *n+1* coefficients.POLYROOT([*coefficients*])**Example**For  $x^4+2x^3-25x^2-26x+120$ :POLYROOT([1, 2, -25, -26, 120]) returns  
[2, -3, 4, -5].**HINT**

---

The results of POLYROOT will often not be easily seen in HOME due to the number of decimal places, especially if they are complex numbers. It is better to store the results of POLYROOT to a matrix.

---

For example, POLYROOT([1, 0, 0, -8]) **STO** M1 will store the three complex cube roots of 8 to matrix M1 as a complex vector. Then you can see them easily by going to the Matrix Catalog. and access them individually in calculations by referring to M1(1), M1(2) etc.

---

**Probability functions****COMB**Number of combinations (without regard to order) of *n* things taken *r* at a time:  $n!/(r!(n-r))$ .COMB(*n*, *r*)**Example**

COMB(5, 2) returns 10. That is, there are ten different ways that five things can be combined two at a time.!

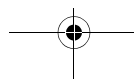



Factorial of a positive integer. For non-integers,  $x! = \Gamma(x + 1)$ . This calculates the gamma function.

*value!*

### PERM

Number of permutations (with regard to order) of  $n$  things taken  $r$  at a time:  $n!/(r!(n-r)!)$

PERM( $n, r$ )

#### Example

PERM(5, 2) returns 20. That is, there are 20 different permutations of five things taken two at a time.

### RANDOM

Random number (between zero and 1). Produced by a pseudo-random number sequence. The algorithm used in the RANDOM function uses a seed number to begin its sequence. To ensure that two calculators must produce different results for the RANDOM function, use the RANDSEED function to seed different starting values before using RANDOM to produce the numbers.

RANDOM

### HINT

The setting of Time will be different for each calculator, so using RANDSEED(Time) is guaranteed to produce a set of numbers which are as close to random as possible. You can set the seed using the command RANDSEED.

### UTPC

Upper-Tail Chi-Squared Probability given *degrees* of freedom, evaluated at *value*. Returns the probability that a  $\chi^2$  random variable is greater than *value*.

UTPC(*degrees, value*)

### UTPF

Upper-Tail Snedecor's F Probability given *numerator* degrees of freedom and *denominator* degrees of freedom (of the F distribution), evaluated at *value*. Returns the probability that a Snedecor's F random variable is greater than *value*.

UTPF(*numerator, denominator, value*)

### UTPN

Upper-Tail Normal Probability given *mean* and *variance*, evaluated at *value*. Returns the probability that a normal random variable is greater than *value* for a normal distribution. *Note: The variance is the square of the standard deviation.*

UTPN(*mean, variance, value*)

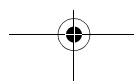
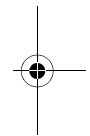
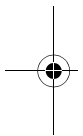

**UTPT**

Upper-Tail Student's t-Probability given *degrees* of freedom, evaluated at *value*. Returns the probability that the Student's t- random variable is greater than *value*.

`UTPT(degrees, value)`

**Real-number functions**

Some real-number functions can also take complex arguments.

**CEILING**

Smallest integer greater than or equal to *value*.

`CEILING(value)`

**Examples**

`CEILING(3.2)` returns 4

`CEILING(-3.2)` returns -3

**DEG→RAD**

Degrees to radians. Converts *value* from Degrees angle format to Radians angle format.

`DEG→RAD(value)`

**Example**

`DEG→RAD(180)` returns 3.14159265359, the value of  $\pi$ .

**FLOOR**

Greatest integer less than or equal to *value*.

`FLOOR(value)`

**Example**

`FLOOR(-3.2)` returns -4

**FNROOT**

Function root-finder (like the Solve aplet). Finds the value for the given *variable* at which *expression* most nearly evaluates to zero. Uses *guess* as initial estimate.

`FNROOT(expression, variable, guess)`

**Example**

`FNROOT(M*9.8/600-1, M, 1)` returns 61.2244897959.

**FRAC**

Fractional part.

`FRAC(value)`

**Example**

`FRAC(23.2)` returns .2

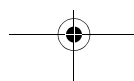



**HMS→**

Hours-minutes-seconds to decimal. Converts a number or expression in *H.MMSSs* format (time or angle that can include fractions of a second) to *x.x* format (number of hours or degrees with a decimal fraction).

$\text{HMS}\rightarrow(H.MMSSs)$

**Example**

$\text{HMS}\rightarrow(8.30)$  returns 8.5

**→HMS**

Decimal to hours-minutes-seconds. Converts a number or expression in *x.x* format (number of hours or degrees with a decimal fraction) to *H.MMSSs* format (time or angle up to fractions of a second).

$\rightarrow\text{HMS}(x.x)$

**Example**

$\rightarrow\text{HMS}(8.5)$  returns 8.3

**INT**

Integer part.

$\text{INT}(value)$

**Example**

$\text{INT}(23.2)$  returns 23

**MANT**

Mantissa (significant digits) of *value*.

$\text{MANT}(value)$

**Example**

$\text{MANT}(21.2E34)$  returns 2.12

**MAX**

Maximum. The greater of two values.

$\text{MAX}(value1, value2)$

**Example**

$\text{MAX}(210, 25)$  returns 210

**MIN**

Minimum. The lesser of two values.

$\text{MIN}(value1, value2)$

**Example**

$\text{MIN}(210, 25)$  returns 25

**MOD**

Modulo. The remainder of *value1*/*value2*.

$value1 \text{ MOD } value2$

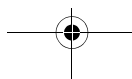
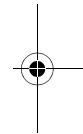
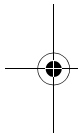



**Example**

9 MOD 4 returns 1

**%**

*x* percent of *y*; that is,  $x/100*y$ .

`% ( x, y )`

**Example**

`% ( 20, 50 )` returns 10

**%CHANGE**

Percent change from *x* to *y*, that is,  $100(y-x)/x$ .

`%CHANGE( x, y )`

**Example**

`%CHANGE ( 20, 50 )` returns 150

**%TOTAL**

Percent total :  $(100)y/x$ . What percentage of *x*, is *y*.

`%TOTAL( x, y )`

**Example**

`%TOTAL ( 20, 50 )` returns 250

**RAD→DEG**

Radians to degrees. Converts *value* from radians to degrees.

`RAD→DEG ( value )`

**Example**

`RAD→DEG (  $\pi$  )` returns 180

**ROUND**

Rounds *value* to decimal *places*. Accepts complex numbers.

`ROUND( value, places )`

Round can also round to a number of significant digits as showed in example 2.

**Examples**

`ROUND ( 7.8676, 2 )` returns 7.87

`ROUND ( 0.0036757, -3 )` returns 0.00368

**SIGN**

Sign of *value*. If positive, the result is 1. If negative, -1. If zero, result is zero. For a complex number, this is the unit vector in the direction of the number.

`SIGN( value )`

`SIGN( ( x, y ) )`

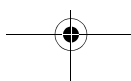



### Examples

`SIGN (-2)` returns  $-1$

`SIGN ((3, 4))` returns  $(.6, .8)$

### TRUNCATE

Truncates *value* to decimal *places*. Accepts complex numbers.

`TRUNCATE(value, places)`

### Example

`TRUNCATE(2.3678, 2)` returns  $2.36$

### XPON

Exponent of *value*.

`XPON(value)`

### Example

`XPON(123.4)` returns  $2$

## Two-variable statistics

These are functions for use with two-variable statistics. See "Two-variable" on page 10-15.

## Symbolic functions

The symbolic functions are used for symbolic manipulations of expressions. The variables can be formal or numeric, but the result is usually in symbolic form (not a number). You will find the symbols for the symbolic functions = and | (*where*) in the CHARS menu (`SHIFT CHARS`) as well as the MATH menu.

### = (*equals*)

Sets an equality for an equation. This is *not* a logical operator and does *not* store values. (See "Test functions" on page 13-19.)

*expression 1 = expression 2*

### ISOLATE

Isolates the first occurrence of *variable* in *expression=0* and returns a new expression, where *variable=newexpression*. The result is a general solution that represents multiple solutions by including the (formal) variables *S1* to represent any sign and *n1* to represent any integer.

`ISOLATE (expression, variable)`

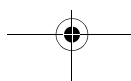
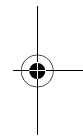
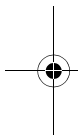

**Examples**

ISOLATE (2\*X+8, X) returns -4  
 ISOLATE (A+B\*X/C, X) returns -(A\*C/B)

**LINEAR?**

Tests whether *expression* is linear for the specified *variable*. Returns 0 (false) or 1 (true).

LINEAR? (*expression, variable*)

**Example**

LINEAR? ((X^2-1)/(X+1), X) returns 0

**QUAD**

Solves quadratic *expression*=0 for *variable* and returns a new expression, where *variable*=*newexpression*. The result is a general solution that represents both positive and negative solutions by including the formal variable *S1* to represent any sign: + or - .

QUAD (*expression, variable*)

**Example**

QUAD ((X-1)^2-7, X) returns (2+s1\*(2\*sqrt(7)))/2

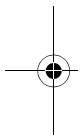
**QUOTE**

Encloses an expression that should not be evaluated numerically.

QUOTE (*expression*)

**Examples**

QUOTE (SIN(45)) **STO>** F1(X) stores the expression SIN(45) rather than the value of SIN(45).

Another method is to enclose the expression in single quotes.

For example, X^3+2\*X **STO>** F1(X) puts the expression X^3+2\*X into F1(X) in the Function aplet.

**| (*where*)**

Evaluates *expression* where each given variable is set to the given *value*. Defines numeric evaluation of a symbolic expression.

*expression* | (*variable1=value1, variable2=value2,...*)

**Example**

3\*(X+1) | (X=3) returns 12.

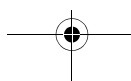



## Test functions

The test functions are *logical* operators that always return either a 1 (*true*) or a 0 (*false*).

< Less than. Returns 1 if true, 0 if false.

$value1 < value2$

≤ Less than or equal to. Returns 1 if true, 0 if false.

$value1 \leq value2$

== Equals (logical test). Returns 1 if true, 0 if false.

$value1 == value2$

≠ Not equal to. Returns 1 if true, 0 if false.

$value1 \neq value2$

> Greater than. Returns 1 if true, 0 if false.

$value1 > value2$

≥ Greater than or equal to. Returns 1 if true, 0 if false.

$value1 \geq value2$

### AND

Compares *value1* and *value2*. Returns 1 if they are both non-zero, otherwise returns 0.

$value1 \text{ AND } value2$

### IFTE

If *expression* is true, do the *trueclause*; if not, do the *falseclause*.

IFTE (*expression*, *trueclause*, *falseclause*)

### Example

IFTE ( $X > 0$ ,  $X^2$ ,  $X^3$ )

### NOT

Returns 1 if *value* is zero, otherwise returns 0.

NOT *value*

### OR

Returns 1 if either *value1* or *value2* is non-zero, otherwise returns 0.

$value1 \text{ OR } value2$

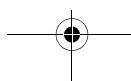
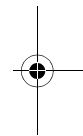
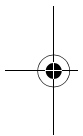

**XOR**

Exclusive OR. Returns 1 if either *value1* or *value2*—but not both of them—is non-zero, otherwise returns 0.

*value1* XOR *value2*

**Trigonometry functions**

The trigonometry functions can also take complex numbers as arguments. For SIN, COS, TAN, ASIN, ACOS, and ATAN, see the Keyboard category.

**ACOT**

Arc cotangent.

ACOT(*value*)

**ACSC**

Arc cosecant.

ACSC(*value*)

**ASEC**

Arc secant.

ASEC(*value*)

**COT**

Cotangent:  $\cos x / \sin x$ .

COT(*value*)

**CSC**

Cosecant:  $1 / \sin x$

CSC(*value*)

**SEC**

Secant:  $1 / \cos x$ .

SEC(*value*)

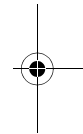
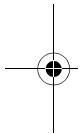
**Symbolic calculations**

Although CAS provides the richest environment for performing symbolic calculations, you can perform some symbolic calculations in HOME and with the Function aplet. CAS functions that you can perform in HOME (such as DERVX and INTVX) are discussed in "Using CAS functions in HOME" on page 14-7.

**In HOME**

When you perform calculations that contain normal variables, the calculator substitutes values for any variables. For example, if you enter  $A+B$  on the command line and press **ENTER**, the calculator retrieves the values for A and B from memory and substitutes them in the calculation.

**Using formal variables**

To perform symbolic calculations, for example symbolic differentiations and integrations, you need to use formal

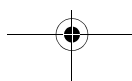



names. The HP 40gs has six formal names available for use in symbolic calculations. These are S1 to S5. When you perform a calculation that contains a formal name, the HP 40gs does not carry out any substitutions.

You can mix formal names and real variables. Evaluating  $(A+B+S1)^2$  will evaluate  $A+B$ , but not  $S1$ .

If you need to evaluate an expression that contains formal names numerically, you use the | (*where*) command, listed in the Math menu under the Symbolic category.

For example to evaluate  $(S1*S2)^2$  when  $S1=2$  and  $S2=4$ , you would enter the calculation as follows:

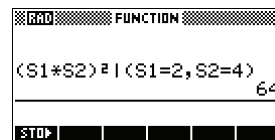

(The | symbol is in the CHARS menu: press  $\text{[SHIFT]}$  CHARS. The = sign is listed in the MATH menu under Symbolic functions.)

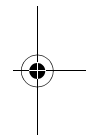
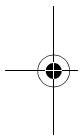

## Symbolic calculations in the Function aplet

You can perform symbolic operations in the Function aplet's Symbolic view. For example, to find the derivative of a function in the Function aplet's Symbolic view, you define two functions and define the second function as a derivative of the first function. You then evaluate the second function. See "To find derivatives in the Function aplet's Symbolic view" on page 13-22 for an example.

## Finding derivatives

The HP 40gs can perform symbolic differentiation on some functions. There are two ways of using the HP 40gs to find derivatives.

- You can perform differentiations in HOME by using the formal variables, S1 to S5.
- You can perform differentiations of functions of X in the Function aplet.

### To find derivatives in HOME

To find the derivative of the function in HOME, use a formal variable in place of X. If you use X, the

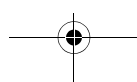

differentiation function substitutes the value that X holds, and returns a numeric result.

For example, consider the function:

$$dx(\sin(x^2) + 2 \cos(x))$$

1. Enter the differentiation function onto the command line, substituting S1 in place of x.

d/dx ALPHA S1  
 ( SIN ALPHA S1  
 X<sup>2</sup> ) + 2 X  
 COS ALPHA S1  
 ) )



2. Evaluate the function.

ENTER

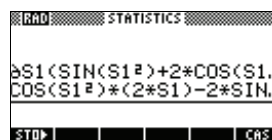

3. Show the result.

▲ SHOW

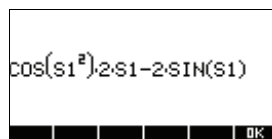

### To find derivatives in the Function applet's Symbolic view

To find the derivative of the function in the Function applet's Symbolic view, you define two functions and define the second function as a derivative of the first function. For example, to differentiate  $\sin(x^2) + 2 \cos x$  :

1. Access the Function applet's Symbolic view and define F1.

SYMB SIN X<sup>2</sup> X<sup>2</sup>  
 ) + 2 X COS  
 X<sup>2</sup> )

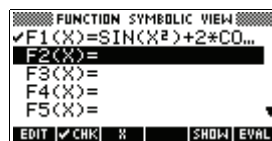

2. Define F2(x) as the derivative of F(1).

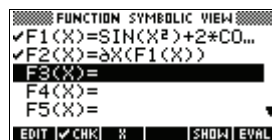



$\frac{d}{dx}$   $X^2$   $($   $\text{ALPHA}$

F1  $($   $X^2$   $)$   $)$

$\text{OK}$

3. Select F2(x) and evaluate it.

$\text{▲}$   $\text{EVAL}$

4. Press  $\text{SHOW}$  to display the result. *Note: Use the arrow keys to view the entire function.*

$\text{SHOW}$   $|$

You could also just define

$$F1(x) = dx(\sin(x^2) + 2\cos(x)) .$$

For example, to find the indefinite integral of

$$\int 3x^2 - 5 dx \text{ use:}$$

$$\int(0, S1, 3X^2 - 5, X)$$

### To find the indefinite integral using formal variables

1. Enter the function.

$\text{SHIFT}$   $\frac{d}{dx}$   $0$   $,$

$\text{ALPHA}$  S1  $,$  3  $\text{X}$

$\text{ALPHA}$  X  $X^2$   $-$  5  $,$

$\text{ALPHA}$  X  $)$   $\text{ENTER}$

2. Show the result format.

$\text{▲}$

$\text{SHOW}$

3. Press  $\text{OK}$  to close the show window.



4. Copy the result and evaluate.

**COPY** **ENTER**

```

RAD  FUNCTION
f(0,S1,3*X^2-5,X)
-5*X+3*(X^3/3/dX(X))1...
-5*X+3*(X^3/3/dX(X))1...
-5*S1+3*(S1^3/3)
STO  CAS
    
```

Thus, substituting X for S1, it can be seen that:

$$\int 3x^2 - 5 dx = -5x + 3 \left( \frac{\frac{x^3}{3}}{\frac{\partial}{\partial X}(X)} \right)$$

This result is derived from substituting  $X=S1$  and  $X=0$  into the original expression found in step 1. However, substituting  $X=0$  will not always evaluate to zero and may result in an unwanted constant.

To see this, consider:  $\int (x-2)^4 dx = \frac{(x-2)^5}{5}$

The 'extra' constant of  $32/5$  results from the substitution of  $x = 0$  into  $(x-2)^5/5$ , and should be disregarded if an *indefinite* integral is required.

```

RAD  FUNCTION
f(0,S1,(X-2)^4,X)
(X-2)^(4+1)/((4+1)*dX...
(X-2)^(4+1)/((4+1)*dX...
(S1-2)^5/5+32/5
STO  CAS
    
```

## Program constants and physical constants

When you press **MATH**, three menus of functions and constants become available:

- the math functions menu (which appears by default)
- the program constants menu, and
- the physical constants menu.

The math functions menu is described extensively earlier in this chapter.





## Program constants

The program constants are numbers that have been assigned to various calculator settings to enable you to test for or specify such a setting in a program. For example, the various display formats are assigned the following numbers:

- 1 Standard
- 2 Fixed
- 3 Scientific
- 4 Engineering
- 5 Fraction
- 6 Mixed fraction

In a program, you could store the constant number of a particular format into a variable and then subsequently test for that particular format.

To access the menu of program constants:

1. Press **MATH**.
2. Press **CONS**.
3. Use the arrow keys to navigate through the options.
4. Click **OK** and then **ENTER** to display the number assigned to the option you selected in the previous step.

The use of program constants is illustrated in more detail in "Programming" on page 21-1

## Physical constants

There are 29 physical constants—from the fields of chemistry, physics and quantum mechanics—that you can use in calculations. A list of all these constants can be found in "Physical Constants" on page R-16.

To access the menu of physical constants:

1. Press **MATH**.
2. Press **PHYS**.

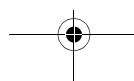
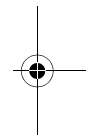
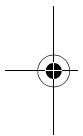



3. Use the arrow keys to navigate through the options.
4. To see the symbol and value of a selected constant, press  $\text{INFO}$ . (Click  $\text{OK}$  to close the information window that appears.)

The following example shows the information available about the speed of light (one of the physics constants).



5. To use the selected constant in a calculation, press  $\text{OK}$ . The constant appears at the position of the cursor on the edit line.

### Example

Suppose you want to know the potential energy of a mass of 5 units according to the equation  $E = mc^2$ .

1. Enter 5  $\text{X}$

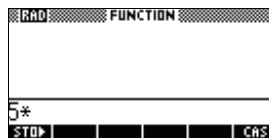

2. Press  $\text{MATH}$  and then press  $\text{INFO}$ .

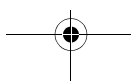



3. Select light s... from the Physics menu.



4. Press  $\square$ . The menu closes and the value of the selected constant is copied to the edit line.

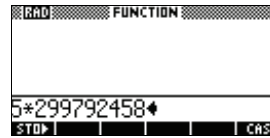

5. Complete the equation as you would normally and press  $\square$  to get the result.

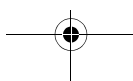
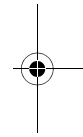
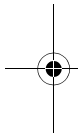
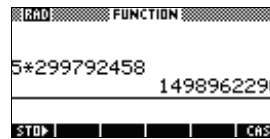

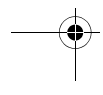
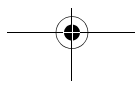
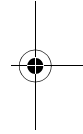
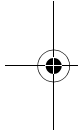
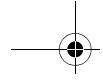



## Computer Algebra System (CAS)

---

### What is a CAS?

A computer algebra system (hereafter CAS) enables you to perform symbolic calculations. With a CAS you manipulate mathematical equations and expressions in symbolic form, rather than manipulating approximations of the numerical quantities represented by those symbols. In other words, a CAS works in *exact mode*, giving you infinite precision. On the other hand, non-CAS calculations, such as those performed in HOME view or by an applet, are numerical calculations and are limited by the precision of the calculator (to  $10^{-12}$  in the case of the HP 40gs).

For example, with Standard as your numerical format,  $1/2 + 1/6$  returns 0.6666666666667 if you are working in the HOME screen; however,  $1/2 + 1/6$  returns  $2/3$  if you are working with CAS. HOME calculations are restricted to *approximate* (or *numeric*) mode, while CAS calculations always work in exact mode (unless you specifically change the default CAS modes).

Each mode has advantages and disadvantages. For example, in exact mode there is no rounding error, but some calculations will take much longer to complete and require more memory than equivalent calculations in numeric mode.

### Performing symbolic calculations

You perform CAS calculations with a special tool known as the *Equation Writer*. Some computer algebra operations can also be done in the HOME screen, as long as you take certain precautions (see "Using CAS functions in HOME" on page 14-7). Moreover, some computer algebra operations can only be done in the HOME screen; for example, symbolic linear algebra

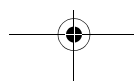
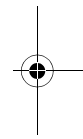
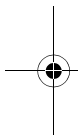



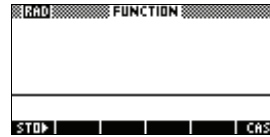

using vectors and matrices. (Vectors and matrices cannot be entered using the Equation Writer).

To open the Equation Writer, press the  softkey on the menu bar of the HOME screen.

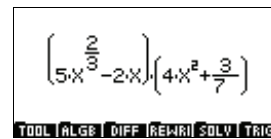

The illustration at the right shows an expression being written in the Equation Writer. The soft keys on the menu bar provide access to CAS functions and commands.





To leave the Equation Writer, press  to return to the HOME screen. Note that expressions written in the Equation Writer (and the results of evaluating an expression) are not automatically copied to the HOME history when you leave the Equation Writer. (You can, however, manually copy them to HOME: see page 14-8).

CAS functions are described in detail in "CAS functions in the Equation Writer" on page 14-9. Chapter 15, "Equation Writer", explains in detail how to enter an expression in the Equation Writer and contains numerous worked examples of CAS in operation.

## An example

To give you an idea of how CAS works, let's consider a simple example. Suppose you want to convert  $C$  to the form  $d \cdot \sqrt{5}$  where  $C$  is  $2\sqrt{45} - \sqrt{20}$  and  $d$  is a whole number.

1. Open the Equation Writer by pressing the  softkey on the HOME screen.
2. Enter the expression for  $C$ .

[**Hint:** use the keys on the keyboard as you would if entering the expression in HOME. Press the  key twice to select the entire first term before entering the second term.]

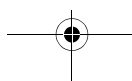
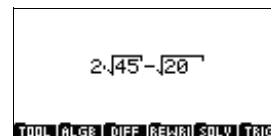





3. Press  $\rightarrow$  and  $\downarrow$  to select just the 20 in the  $\sqrt{20}$  term.

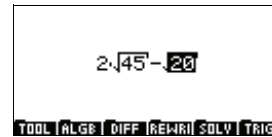

4. Press the **ALGB** menu key and choose FACTOR. Then press  $\rightarrow$ .



Note that the FACTOR function is added to the selected term.

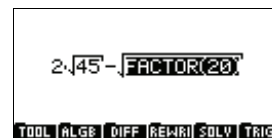

5. Press  $\rightarrow$  to factor the selected term.

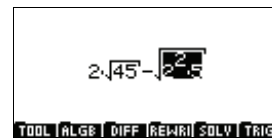

6. Press  $\uparrow$  to select the entire second term, and then press  $\rightarrow$  to simplify it.

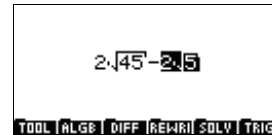

7. Press  $\rightarrow$   $\rightarrow$   $\downarrow$   $\downarrow$   $\rightarrow$   $\downarrow$  to select the 45 in the first term.

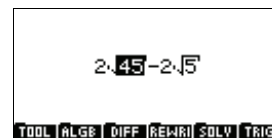

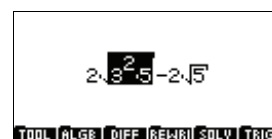

8. As you did earlier, press the **ALGB** menu key and choose FACTOR. Then press  $\rightarrow$  and  $\rightarrow$  to factor the selected term.

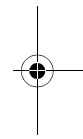
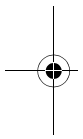
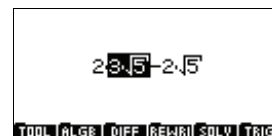

9. Press  $\uparrow$  to select the entire second term, and then press  $\rightarrow$  to simplify it.





10. Press  three times to select the entire expression and then press  to simplify it to the form required.



## CAS variables

When you use the symbolic calculation functions, you are working with symbolic variables (variables that do not contain a permanent value). In the HOME screen, a variable of this kind must have a name like S1...S5, s1...s5, n1...n5, but not X, which is assigned to a real value. (By default, X is assigned to 0). To store symbolic expressions, you must use the variables E0, E1...E9.

In the Equation Writer, all the variables may, or may not be, assigned. For example, X is not assigned to a real value by default, so computing  $X + X$  will return  $2X$ .

Moreover, Equation Writer variables can have long names, like XY or ABC, unlike in HOME where implied multiplication is assumed. (For example ABC is interpreted as  $A \times B \times C$  in HOME.) For these reasons, variables used in the Equation Writer cannot be used in HOME, and vice versa.

Using the PUSH command, you can transfer expressions from the HOME screen history to CAS history (see page 14-8). Likewise, you can use the POP command to transfer expressions from CAS history to the HOME screen history (see page 14-8).

## The current variable

In the Equation Writer, the current variable is the name of the symbolic variable contained in VX. It is almost always X. (The current variable is always S1 in HOME.)

Some CAS functions depend on a current variable; for example, the function DERVX calculates the derivative with respect to the current variable. Hence in the Equation Writer,  $DERVX(2*X+Y)$  returns 2 if  $VX = X$ , but 1 if  $VX = Y$ . However, in the HOME screen,  $DERVX(2*S1+S2)$  returns 2, but  $DERIV(2*S1+S2,S2)$  returns 1.

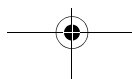
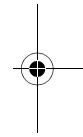
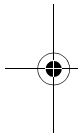

## CAS modes

The modes that determine how CAS operates can be set on CAS MODES screen. To display CAS MODES screen, press:

**SHIFT** **MODES**

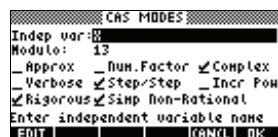

To navigate through the options in CAS MODES screen, press the arrow keys.

To select or deselect a mode, navigate to the appropriate field and press **CHN** until the correct setting is displayed (indicated by a check mark in the field). For some settings (such as INDEP VAR and MODULO), you will need to press **EDIT** to be able to change the setting.

Press **EXIT** to close CAS MODES screen.

### NOTE

You can also set CAS modes from within the Equation Writer. See "Configuration menus" on page 15-3 for information.

### Selecting the independent variable

Many of the functions provided by CAS use a pre-determined independent variable. By default, that variable is the letter X (upper case) as shown in CAS MODES screen above. However, you can change this variable to any other letter, or combination of letters and numbers, by editing the INDEP VAR field in CAS MODES screen. To change the setting, press **EDIT**, enter a new value and then press **EXIT**.

The variable VX in the calculator's {HOME CASDIR} directory takes, by default, the value of 'X'. This is the name of the preferred independent variable for algebraic and calculus applications. If you use another independent variable name, some functions (for example, HORNER) will not work properly.

### Selecting the modulus

The MODULO option on CAS MODES screen lets you specify the modulo you want to use in modular arithmetic. The default value is 13.

### Approximate vs. Exact mode

When the APPROX mode is selected, symbolic operations (for example, definite integrals, square roots, etc.), will be calculated numerically. When this mode is unselected, *exact mode* is active, hence symbolic operations will be



calculated as closed-form algebraic expressions, whenever possible. [Default: unselected.]

### **Num. Factor mode**

When the `NUMFACTOR` setting is selected, approximate roots are used when factoring. For example,  $x^5 + 5x + 1$  is irreducible over the integers but has approximate roots over the reals. With `NUMFACTOR` set, the approximate roots are returned. [Default: unselected.]

### **Complex vs. Real mode**

When `COMPLEX` is selected and an operation results in a complex number, the result will be shown in the form  $a + bi$  or in the form of an ordered pair  $(a,b)$ . If `COMPLEX` mode is not selected and an operation results in a complex number, you will be asked to switch to `COMPLEX` mode. If you decline, the calculator will report an error. [Default: unselected.]

When in `COMPLEX` mode, CAS is able to perform a wider range of operations than in non-complex (or real) mode, but it will also be considerably slower. Thus, it is recommended that you don't select `COMPLEX` mode unless requested by the calculator in the performance of a particular operation.

### **Verbose vs. non-verbose mode**

When `VERBOSE` is selected, certain calculus applications are provided with comment lines in the main display. The comment lines will appear in the top lines of the display, but only while the operation is being calculated. [Default: unselected.]

### **Step-by-step mode**

When `STEP/STEP` is selected, certain operations will be shown one step at a time in the display. You press `ENTER` to show each step in turn. [Default: selected.]

### **Increasing-powers mode**

When `INCR POW` is selected, polynomials will be listed so that the terms will have increasing powers of the independent variable (which is the opposite to how polynomials are normally written). [Default: unselected.]

### **Rigorous setting**

When `RIGOROUS` is selected, any algebraic expression of the form  $|X|$ , i.e., the absolute value of  $X$ , is not simplified to  $X$ . [Default: selected.]

### **Simplify non-rational setting**

When `SIMP NON-RATIONAL` is selected, non-rational expressions will be automatically simplified. [Default: selected.]

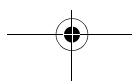
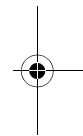
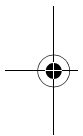

## Using CAS functions in HOME

You can use many computer algebra functions directly in the HOME screen, as long as you take certain precautions. CAS functions that take matrices as an argument work only from HOME.

CAS functions can be accessed by pressing  $\alpha$  when MATH menu is displayed. You can also directly type a function name when you are in alpha mode.

Note that certain calculations will be performed in approximate mode because numbers are interpreted as reals instead of integers in HOME. To do exact calculations, you should use the XQ command. This command converts an approximate argument into an exact argument.

For example, if Radians is your angle setting, then:

$$\text{ARG}(\text{XQ}(1 + i)) = \pi/4 \text{ but}$$

$$\text{ARG}(1 + i) = 0.7853\dots$$

Similarly:

$$\text{FACTOR}(\text{XQ}(45)) = 3^2 \times 5 \text{ but}$$

$$\text{FACTOR}(45) = 45$$

Note too that the symbolic HOME variable S1 serves as the current variable for CAS functions in HOME. For example:

$$\text{DERVX}(S1^2 + 2 \times S1) = 2 \times S1 + 2$$

The result  $2 \times S1 + 2$  does not depend on the Equation Writer variable,  $\nabla x$ .

Some CAS functions cannot work in HOME because they require a change to the current variable.

Remember that you must use S1,S2,...S5, s1,s2,...s5, and n1,n2,...n5 for symbolic variables and E0, E1,...E9 to store symbolic expressions. For example, if you type:

$$S1^2 - 4 \times S2 \quad \alpha \quad E1$$

then you get:

$$\text{DERVX}(E1) = S1 \times 2$$

$$\text{DERIV}(E1, S2) = -4$$

$$\text{INTVX}(E1) = 1/3 S1^3 - 4 \times (S2 \times S1)$$



Symbolic matrices are stored as a list of lists and therefore must be stored in L0, L1...L9 (whereas numeric matrices are stored in M0, M1,...M9). CAS linear algebra instructions accept lists of lists as input.

For example, if you type in HOME:

`XQ({{S2 + 1, 1}, {√2, 1}}) STO L1`

then you have:

`TRAN(L1) = {{S2 + 1, √2}, {1, 1}}`

Some numeric linear algebra commands do not directly work on a list of lists, but will do so after a conversion by AXL. For example, if you enter:

`DET(AXL(L1)) STO E1`

you get:

`S2 - (-1 + √2)`

### Send expressions from HOME to CAS history

In the HOME screen, you can use the `PUSH` command to send expressions to CAS history. For example, if you enter `PUSH(S1+1)`, `S1+1` is written to CAS history.

### Send expressions from CAS to HOME history

In the HOME screen, you can use the `POP` command to retrieve the last expression written to CAS history. For example, if `S1+1` is the last expression written to CAS history and you enter `POP` in the HOME screen, `S1+1` is written to the HOME screen history (and `S1+1` is removed from CAS history).

## Online Help

When you are working with the Equation Writer, you can display online help about any CAS command. To display the contents of the online help, press `SHIFT` 2.



Press `▼` to navigate to the command you want help with and then press `ENT`.

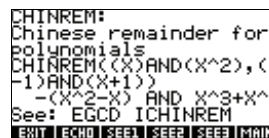

You can also get CAS help from the HOME screen. Type

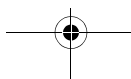



HELP and press  $\boxed{\text{ENTER}}$ . The menu of help topics appears.

Each help topic includes the required syntax, along with real sample values. You can copy the syntax, with the sample values, to the HOME screen or to the Equation Writer, by pressing  $\boxed{\text{EDIT}}$ .

**TIP** If you highlight a CAS command and then press  $\boxed{\text{SHIFT}}$  2, help about the highlighted command is displayed.

You can display the online help in French rather than English. For instructions, see “Online Help language” on page 15-4.

## CAS functions in the Equation Writer

You can display a menu of CAS functions in four ways:

- by displaying the MATH menu from HOME and then pressing  $\boxed{\text{MATH}}$ , or
- opening the Equation Writer and pressing  $\boxed{\text{MATH}}$ ,
- opening the Equation Writer and selecting a function from a soft-key menu, or
- opening the Equation Writer and pressing  $\boxed{\text{SHIFT}}$   $\boxed{\text{MATH}}$ .

You can also directly type the name of a CAS function when you are in ALPHA mode.

Note that in this section, CAS functions available from the soft-key menus in the Equation Writer are described. CAS functions available from the MATH menu are described in “CAS Functions on the MATH menu” on page 14-45.

**NOTE** When using CAS, you should be aware that the required syntax will vary depending on whether you are applying the command to an expression or a function. All CAS commands are designed to work with expressions; that is, they take expressions as arguments. If you are going to use a function—for example, F—you need to specify an expression made from this function, such as  $F(x)$ , where  $x$  is the independent variable.

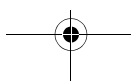
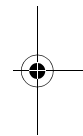
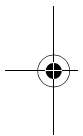



For example, suppose you have stored the *expression*  $x^2$  in  $G$ , and have defined the *function*  $F(x)$  as  $x^2$ . Suppose now you want to calculate  $\text{INTVX}(X^2)$ . You could:

- enter  $\text{INTVX}(X^2)$  directly, or
- enter  $\text{INTVX}(G)$ , or
- enter  $\text{INTVX}(F(X))$ .

Note that you can apply the command directly to an expression or to a variable that holds an expression (the first two cases above). But where you want to apply it to a defined function, you need to specify the full function name,  $F(X)$ , as in the third case above.

## ALGB menu

### COLLECT

#### Factors over the integers

COLLECT combines like terms and factors the expression over the integers.

#### Example

To factor  $x^2 - 4$  over the integers you would type:

```
COLLECT(X^2-4)
```

which gives in real mode:

$$(x + 2) \cdot (x - 2)$$

#### Example

To factor  $x^2 - 2$  over the integers you would type:

```
COLLECT(X^2-2)
```

which gives:

$$x^2 - 2$$

### DEF

#### Define a function

For its argument, DEF takes an equality between:

1. the name of a function (with parentheses containing the variable), and
2. an expression defining the function.

DEF defines this function and returns the equality.

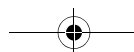
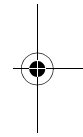
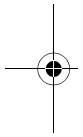



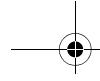

Typing:

$$\text{DEF}(U(N) = 2N+1)$$

produces the result:

$$U(N) = 2N+1$$

Typing:

$$U(3)$$

then returns:

7

### Example

Calculate the first six Fermat numbers  $F_1 \dots F_6$  and determine whether they are prime.

So, you want to calculate:

$$F(k) = 2^{2^k} + 1 \text{ for } k = 1 \dots 6$$

Typing the formula:

$$2^{2^2} + 1$$

gives a result of 17. You can then invoke the `ISPRIME?()` command, which is found in the `MATH` key's `Integer` menu. The response is 1, which means `TRUE`. Using the history (which you access by pressing the

`SYMB` key), you put the expression  $2^{2^2} + 1$  into the Equation Writer with `ECHO`, and change it to:

$$2^{2^3} + 1$$

Or better, define a function  $F(K)$  by selecting `DEF` from the `ALGB` menu on the menu bar and type:

$$\text{DEF}(F(K) = 2^{2^k} + 1)$$

The response is  $2^{2^k} + 1$  and  $F$  is now listed amongst the variables (which you can verify using the `VARS` key).

For  $K=5$ , you then type:

$$F(5)$$

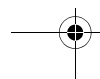
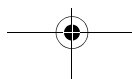
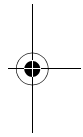
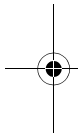



which gives

4294967297

You can factor  $F(5)$  with **FACTOR**, which you'll find in the **ALGB** menu on the menu bar.

Typing:

`FACTOR(F(5))`

gives:

641 · 6700417

Typing:

`F(6)`

gives:

18446744073709551617

Using **FACTOR** to factor it, then yields:

274177 · 67280421310721

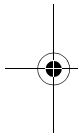

## EXPAND

### Distributivity

**EXPAND** expands and simplifies an expression.

### Example

Typing:

`XPAND((X2 + √2 · X + 1) · (X2 - √2 · X + 1))`

gives:

$x^4 + 1$

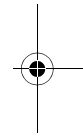

## FACTOR

### Factorization

**FACTOR** factors an expression.

### Example

To factor:

$x^4 + 1$

type:

`FACTOR(X4+1)`

**FACTOR** is located in the **ALGB** menu.

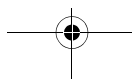



In real mode, the result is:

$$(x^2 + \sqrt{2} \cdot x + 1) \cdot (x^2 - \sqrt{2} \cdot x + 1)$$

In complex mode (using CFG), the result is:

$$\frac{1}{16} \cdot (2x + (1 + i) \cdot \sqrt{2}) \cdot (2x - (1 + i) \cdot \sqrt{2}) \cdot (2x + (1 - i) \cdot \sqrt{2}) \cdot (2x - (1 - i) \cdot \sqrt{2})$$

## PARTFRAC

### Partial fraction expansion

PARTFRAC has a rational fraction as an argument.

PARTFRAC returns the partial fraction decomposition of this rational fraction.

#### Example

To perform a partial fraction decomposition of a rational function, such as:

$$\frac{x^5 - 2 \cdot x^3 + 1}{x^4 - 2 \cdot x^3 + 2 \cdot x^2 - (2 \cdot x + 1)}$$

you use the PARTFRAC command.

In real and direct mode, this produces:

$$x + 2 + \frac{x - 3}{2 \cdot x^2 + 2} + \frac{-1}{2 \cdot x - 2}$$

In complex mode, this produces:

$$x + 2 + \frac{1 - 3i}{x + i} + \frac{-1}{x - 1} + \frac{1 + 3i}{x - i}$$

## QUOTE

### Quoted expression

QUOTE(expression) is used to prevent an expression from being evaluated or simplified.

#### Example 1

Typing:

$$\text{im}\left(\text{QUOTE}((2X - 1) \cdot \text{EXP}\left(\frac{1}{X} - 1\right)), X = +\infty\right)$$

gives:

$$+\infty$$

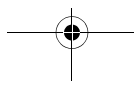
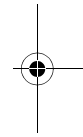
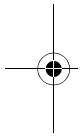

**Example 2**

Typing:

$$\text{SUBST}(\text{QUOTE}(\text{CONJ}(Z)), Z=1+i)$$

gives:

$$\text{CONJ}(1+i)$$
**STORE****Store an object in a variable**

STORE stores an object in a variable.

STORE is found in the ALGB menu or the Equation Writer menu bar.

**Example**

Type:

$$\text{STORE}(X^2-4, \text{ABC})$$

or type:

$$X^2-4$$

then select it and call STORE, then type ABC, then press ENTER to confirm the definition of the variable ABC.

To clear the variable, press VARS in the Equation Writer (then choose PURGE on the menu bar), or select UNASSIGN on the ALGB menu by typing, for example,

$$\text{UNASSIGN}(\text{ABC})$$
**Substitute a value for a variable**

| is an infix operator used to substitute a value for a variable in an expression (similar to the function SUBST).

| has two parameters: an expression dependent on a parameter, and an equality (parameter=substitute value).

| substitutes the specified value for the variable in the expression.

Typing:

$$X^2-1|_{X=2}$$

gives:

$$2^2-1$$

**SUBST****Substitute a value for a variable**

SUBST has two parameters: an expression dependent on a parameter, and an equality (parameter=substitute value).

SUBST substitutes the specified value for the variable in the expression.

Typing:

```
SUBST (A2+1, A=2)
```

gives:

$$2^2 + 1$$
**TEXPAND****Develop in terms of sine and cosine**

TEXPAND has a trigonometric expression or transcendental function as an argument.

TEXPAND develops this expression in terms of  $\sin(x)$  and  $\cos(x)$ .

**Example**

Typing:

```
TEXPAND (COS (X+Y) )
```

gives:

$$\cos(y) \cdot \cos(x) - \sin(y) \cdot \sin(x)$$
**Example**

Typing:

```
TEXPAND (COS (3 · X) )
```

gives:

$$4 \cdot \cos(x)^3 - 3 \cdot \cos(x)$$
**UNASSIGN****Clear a variable**

UNASSIGN is used to clear a variable, for example:

```
UNASSIGN (ABC)
```

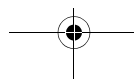
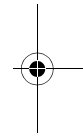
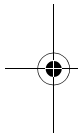



## DIFF menu

### DERIV

#### Derivative and partial derivative

DERIV has two arguments: an expression (or a function) and a variable.

DERIV returns the derivative of the expression (or the function) with respect to the variable given as the second parameter (used for calculating partial derivatives).

#### Example

Calculate:

$$\frac{\partial(x \cdot y^2 \cdot z^3 + x \cdot y)}{\partial z}$$

Typing:

```
DERIV (X·Y2·Z3 + X·Y, Z)
```

gives:

$$3 \cdot x \cdot y^2 \cdot z^2$$

### DERVX

#### Derivative

DERVX has one argument: an expression. DERVX calculates the derivative of the expression with respect to the variable stored in VX.

For example, given:

$$f(x) = \frac{x}{x^2 - 1} + \ln\left(\frac{x+1}{x-1}\right)$$

calculate the derivative of  $f$ .

Type:

```
DERVX( (X/(X2-1) + LN((X+1)/(X-1)))
```

Or, if you have stored the definition of  $f(x)$  in F, that is, if you have typed:

```
TORE( (X/(X2-1) + LN((X+1)/(X-1))), F
```

then type:

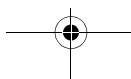

DERVX (F)

Or, if you have defined  $F(X)$  using DEF, that is, if you have typed:

$$\text{DEF}(F(X) = \frac{X}{X^2 - 1} + \text{LN}\left(\frac{X+1}{X-1}\right))$$

then type:

DERVX (F (X) )

Simplify the result to get:

$$\frac{3 \cdot x^2 - 1}{x^4 - 2 \cdot x^2 + 1}$$

## DIVPC

### Division in increasing order by exponent

DIVPC has three arguments: two polynomials  $A(X)$  and  $B(X)$  (where  $B(0) \neq 0$ ), and a whole number  $n$ .

DIVPC returns the quotient  $Q(X)$  of the division of  $A(X)$  by  $B(X)$ , in increasing order by exponent, and with  $\text{deg}(Q) \leq n$  or  $Q = 0$ .

$Q[X]$  is then the limited  $n$ th-order expansion of:

$$\frac{A[X]}{B[X]}$$

in the vicinity of  $X=0$ .

Typing:

$$\text{DIVPC}(1+X^2+X^3, 1+X^2, 5)$$

gives:

$$1 + x^3 - x^5$$

**NOTE:** When the calculator displays a request to change to increasing powers mode, respond yes.

## FOURIER

### Fourier coefficients

FOURIER has two parameters: an expression  $f(x)$  and a whole number  $N$ .

FOURIER returns the Fourier coefficient  $c_N$  of  $f(x)$ , considered to be a function defined over interval  $[0, T]$

and with period  $T$  ( $T$  being equal to the contents of the variable *PERIOD*).

If  $f(x)$  is a discrete series, then:

$$f(x) = \sum_{N=-\infty}^{+\infty} c_N e^{\frac{2iNx\pi}{T}}$$

### Example

Determine the Fourier coefficients of a periodic function  $f$  with period  $2\pi$  and defined over interval  $[0, 2\pi]$  by  $f(x)=x^2$ .

Typing:

```
STORE (2π, PERIOD)
```

```
FOURIER (X2, N)
```

The calculator does not know that  $N$  is a whole number, so you have to replace  $\text{EXP}(2 * i * N * \pi)$  with 1 and then simplify the expression. We get

$$\frac{2 \cdot i \cdot N \cdot \pi + 2}{N^2}$$

So if  $N \neq 0$ , then:

$$c_N = \frac{2 \cdot i \cdot N \cdot \pi + 2}{N^2}$$

Typing:

```
FOURIER (X2, 0)
```

gives:

$$\frac{4 \cdot \pi^2}{3}$$

so if  $N = 0$ , then:

$$c_0 = \frac{4 \cdot \pi^2}{3}$$

### IBP

#### Partial integration

IBP has two parameters: an expression of the form  $u(x) \cdot v'(x)$  and  $v(x)$ .



IBP returns the AND of  $u(x) \cdot v(x)$  and of  $-v(x) \cdot u'(x)$  that is, the terms that are calculated when performing a partial integration.

It remains then to calculate the integral of the second term of the AND, then add it to the first term of the AND to obtain a primitive of  $u(x) \cdot v'(x)$ .

Typing:

`IBP (LN (X) , X)`

gives:

`X · LN (X) AND - 1`

The integration is completed by calling `INTVX`:

`INTVX (X · LN (X) AND - 1)`

which produces the result:

`X · LN (X) - X`

**NOTE:**

If the first IBP (or INTVX) parameter is an AND of two elements, IBP concerns itself only with the second element of the AND, adding the integrated term to the first element of the AND (so that you can perform multiple IBP in succession).

**INTVX**

**Primitive and defined integral**

INTVX has one argument: an expression.

INTVX calculates a primitive of its argument with respect to the variable stored in VX.

**Example**

Calculate a primitive of  $\sin(x) \times \cos(x)$ .

Typing:

`INTVX (SIN (X) · COS (X) )`

gives in step-by-step mode:

`COS (X) · SIN (X)`

`Int[u' * F(u)] with u=SIN(X)`

Pressing OK then sends the result to the Equation Writer:

$$\frac{\sin(x)^2}{2}$$

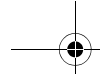
**Example**

Given:

$$f(x) = \frac{x}{x^2 - 1} + \text{LN}\left(\frac{x+1}{x-1}\right)$$

calculate a primitive of  $f$ .

Type:

$$\text{NTVX}\left(\frac{X}{X^2 - 1} + \text{LN}\left(\frac{X+1}{X-1}\right)\right)$$

Or, if you have stored  $f(x)$  in F, that is, if you have already typed:

$$\text{TORE}\left(\frac{X}{X^2 - 1} + \text{LN}\left(\frac{X+1}{X-1}\right), F\right)$$

then type:

$$\text{INTVX}(F)$$

Or, if you have used DEF to define  $f(x)$ , that is, if you have already typed:

$$\text{DEF}(F(X) = \frac{X}{X^2 - 1} + \text{LN}\left(\frac{X+1}{X-1}\right))$$

then type:

$$\text{INTVX}(F(X))$$

The result in all cases is equivalent to:

$$\frac{1}{2} \cdot \text{LN}\left(\frac{X+1}{X-1}\right) + \frac{3}{2} \cdot \text{LN}(|X-1|) + \frac{3}{2} \cdot \text{LN}(|X+1|)$$

You will obtain absolute values only in *Rigorous* mode.  
(See "CAS modes" on page 14-5 for instructions on setting and changing modes.)

**Example**

Calculate:

$$\int \frac{2}{x^6 + 2 \cdot x^4 + x^2} dx$$

Typing:

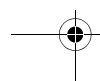
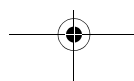

$$\text{NTVX}\left(\frac{2}{X^6 + 2 \cdot X^4 + X^2}\right)$$

gives a primitive:

$$-3 \cdot \text{atan}(x) - \frac{2}{x} - \frac{x}{x^2 + 1}$$

**Note** You can also type  $\int_1^x \frac{2}{X^6 + 2 \cdot X^4 + X^2} dX$  which gives the primitive which is zero for  $x = 1$

$$-3 \cdot \text{atan}(x) - \frac{2}{x} - \left(\frac{x}{x^2 + 1} + \frac{3 \cdot \pi + 10}{4}\right)$$

### Example

Calculate:

$$\int \frac{1}{\sin(x) + \sin(2 \cdot x)} dx$$

Typing:

$$\text{NTVX}\left(\frac{1}{\text{SIN}(X) + \text{SIN}(2 \cdot X)}\right)$$

gives the result:

$$\frac{1}{6} \cdot \text{LN}(|\cos(X) - 1|) + \frac{1}{2} \cdot \text{LN}(|\cos(X) + 1|) + \frac{-2}{3} \cdot \text{LN}(|2 \cos(X) + 1|)$$

**NOTE:** If the argument to INTVX is the AND of two elements, INTVX concerns itself only with the second element of the AND, and adds the result to the first argument.

## lim

### Calculate limits

LIMIT or lim has two arguments: an expression dependent on a variable, and an equality (a variable = the value to which you want to calculate the limit).

You can omit the name of the variable and the sign =, when this name is in VX).

It is often preferable to use a quoted expression:

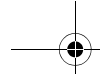

QUOTE(expression), to avoid rewriting the expression in normal form (i.e., not to have a rational simplification of the arguments) during the execution of the LIMIT command.

### Example

Typing:

$$\text{lim}(\text{QUOTE}((2X-1) \cdot \text{EXP}\left(\frac{1}{X-1}\right)), X = +\infty)$$

gives:

$+\infty$

To find a right limit, for example, type:

$$\text{lim}\left(\frac{1}{X-1}, \text{QUOTE}(1+0)\right)$$

gives (if  $X$  is the current variable):

$+\infty$

To find a left limit, for example, type:

$$\text{lim}\left(\frac{1}{X-1}, \text{QUOTE}(1-0)\right)$$

gives (if  $X$  is the current variable):

$-\infty$

It is not necessary to quote the second argument when it is written with =, for example:

$$\text{lim}\left(\frac{1}{X-1}, (X = 1 + 0)\right)$$

gives:

$+\infty$

### Example

For  $n > 2$  in the following expression, find the limit as  $x$  approaches 0:

$$\frac{n \cdot \tan(x) - \tan(n \cdot x)}{\sin(n \cdot x) - n \cdot \sin(x)}$$

You can use the LIMIT command to do this.

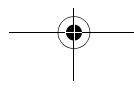
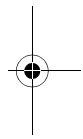
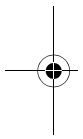



Typing:

$$\lim\left(\frac{N \cdot \text{TAN}(X) - \text{TAN}(N \cdot X)}{\text{SIN}(N \cdot X) - N \cdot \text{SIN}(X)}, 0\right)$$

gives:

2

NOTE: To find the limit as  $x$  approaches  $a^+$  (resp  $a^-$ ), the second argument is written:

$$X=A+0 \text{ (resp } X=A-0)$$

For the following expression, find the limit as  $x$  approaches  $+\infty$ :

$$\sqrt{x + \sqrt{x + \sqrt{x}}} - \sqrt{x}$$

Typing:

$$\lim\left(\sqrt{X + \sqrt{X + \sqrt{X}}} - \sqrt{X}, +\infty\right)$$

produces (after a short wait):

$\frac{1}{2}$

NOTE: the symbol  $\infty$  is obtained by typing SHIFT 0.

To obtain  $-\infty$ :

$$(-)\infty$$

To obtain  $+\infty$ :

$$(-)(-)\infty$$

You can also find the symbol  $\infty$  in the MATH key's Constant menu.

## PREVAL

### Evaluate a primitive

PREVAL has three parameters: an expression  $F(VX)$  dependent on the variable contained in  $VX$ , and two expressions  $A$  and  $B$ .

For example, if  $VX$  contains  $X$ , and if  $F$  is a function, PREVAL ( F ( X ) , A , B ) returns  $F(B) - F(A)$ .

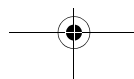
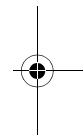
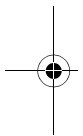

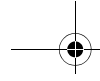

PREVAL is used for calculating an integral defined from a primitive: it evaluates this primitive between the two limits of the integral.

Typing:

```
PREVAL (X2+X, 2, 3)
```

gives:

6

## RISCH

### Primitive and defined integral

RISCH has two parameters: an expression and the name of a variable.

RISCH returns a primitive of the first parameter with respect to the variable specified in the second parameter.

Typing:

```
RISCH ((2 · X2+1) · EXP (X2+1) , X)
```

gives:

```
X · EXP (X2+1)
```

### NOTE:

If the RISCH parameter is the AND of two elements, RISCH concerns itself only with the second element of the AND, and adds the result to the first argument.

## SERIES

### Limited *n*th-order expansion

SERIES has three arguments: an expression dependent on a variable, an equality (the variable  $x =$  the value  $a$  to which you want to calculate the expansion) and a whole number (the order  $n$  of the limited expansion).

You can omit the name of the variable and the = sign when this name is in  $\sqrt{x}$ .

SERIES returns the limited  $n$ th-order expansion of the expression in the vicinity of  $x = a$ .

- **Example — Expansion in the vicinity of  $x=a$**

Give a limited 4th-order expansion of  $\cos(2 \cdot x)^2$  in the vicinity of  $x = \frac{\pi}{6}$ .

For this you use the SERIES command.

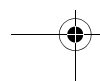
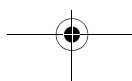
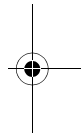
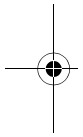

Typing:

$$\text{SERIES}(\text{COS}(2 \cdot X)^2, X = \frac{\pi}{6}, 4)$$

gives:

$$\left\langle \frac{1}{4} - \sqrt{3}h + 2h^2 + \frac{8\sqrt{3}}{3}h^3 - \frac{8}{3}h^4 + 0\left(\frac{h^5}{4}\right) \right\rangle_{h = X - \frac{\pi}{6}}$$

- **Example — Expansion in the vicinity of  $x=+\infty$  or  $x=-\infty$**

### Example 1

Give a 5th-order expansion of  $\arctan(x)$  in the vicinity of  $x=+\infty$ , taking as infinitely small  $h = \frac{1}{x}$ .

Typing:

$$\text{SERIES}(\text{ATAN}(X), X = +\infty, 5)$$

gives:

$$\left( \frac{\pi}{2} - h + \frac{h^3}{3} - \frac{h^5}{5} + 0\left(\frac{\pi \cdot h^6}{2}\right) \right) \Big|_{h = \frac{1}{x}}$$

### Example 2

Give a 2nd-order expansion of  $(2x-1)e^{\frac{1}{x-1}}$  in the vicinity of  $x=+\infty$ , taking as infinitely small  $h = \frac{1}{x}$ .

$$\text{SERIES}((2X-1) \cdot \text{EXP}\left(\frac{1}{X-1}\right), X = +\infty, 3)$$

gives:

$$\frac{12 + 6h + 12h^2 + 17h^3}{6 \cdot h} + 0(2 \cdot h^3) \Big|_{h = \frac{1}{x}}$$

- **Unidirectional expansion**

To perform an expansion in the vicinity of  $x = a$  where  $x > a$ , use a positive real (such as 4.0) for the order.

To perform an expansion in the vicinity of  $x = a$  where  $x < a$ , use a negative real (such as -4.0) for the order.

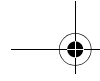

You must be in Rigorous (not Sloppy) mode to apply SERIES with unidirectional expansion. (See "CAS modes" on page 14-5 for instructions on setting and changing modes.)

### Example 1

Give a 3rd-order expansion of  $\sqrt{x^2+x^3}$  in the vicinity of  $x = 0^+$ .

Typing:

$$\text{SERIES}(\sqrt{X^2+X^3}, X=0, 3.0)$$

gives:

$$\frac{1}{16} \cdot h^4 + \frac{-1}{8} \cdot h^3 + \frac{1}{2} \cdot h^2 + h + 0(h^5) \Big| (h=x)$$

### Example 2

Give a 3rd-order expansion of  $\sqrt{x^2+x^3}$  in the vicinity of  $x = 0^-$ .

Typing:

$$\text{SERIES}(\sqrt{X^2+X^3}, X=0, -3.0)$$

gives:

$$\frac{-1}{16} \cdot h^4 + \frac{-1}{8} \cdot h^3 + \frac{-1}{2} \cdot h^2 + h + 0(h^5) \Big| (h=-x)$$

Note that  $h = -x$  is positive as  $x \rightarrow 0^-$ .

### Example 3

If you enter the order as an integer rather than a real, as in:

$$\text{SERIES}(\sqrt{X^2+X^3}, X=0, 3)$$

you will get the following error:

SERIES Error: Unable to find sign.

Note that if you had been in Sloppy rather than Rigorous mode, all three examples above would have returned the same answer as you got when exploring in the vicinity of  $x = 0^+$ :

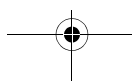
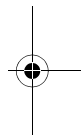
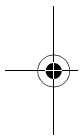



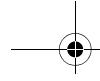

$$\frac{1}{16} \cdot h^4 + \frac{-1}{8} \cdot h^3 + \frac{1}{2} \cdot h^2 + h + 0(h^5) \Big| (h = x)$$

## TABVAR

### Variation table

TABVAR has as a parameter an expression with a rational derivative.

TABVAR returns the variation table for the expression in terms of the current variable.

Typing:

```
TABVAR (3X^2-8X-11)
```

gives, in step-by-step mode:

$$F = (3 \cdot x^2 - 8 \cdot x - 11)$$

$$F' = (3 \cdot 2 \cdot x - 8)$$

$$\rightarrow (2 \cdot (3 \cdot x - 4))$$

Variation table:

$-\infty$	-	$\frac{4}{3}$	+	$+\infty$	X
$+\infty$	↓	$\frac{-49}{3}$	↑	$+\infty$	F

The arrows indicate whether the function is increasing or decreasing during the specified interval. This particular variation table indicates that the function  $F(x)$  decreases for  $x$  in the interval  $[-\infty, \frac{4}{3}]$ , reaching a minimum of  $\frac{-49}{3}$  at  $x = \frac{4}{3}$ . It then increases in the interval  $[\frac{4}{3}, +\infty]$ , reaching a maximum of  $+\infty$ .

Note that “?” appearing in the variation table indicates that the function is not defined in the corresponding interval.

## TAYLORO

### Limited expansion in the vicinity of 0

TAYLORO has a single argument: the function of  $x$  to expand. It returns the function's limited 4th-relative-order expansion in the vicinity of  $x=0$  (if  $x$  is the current variable).

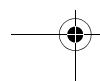
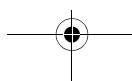
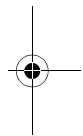
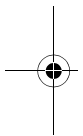



Typing:

$$\text{TAYLOR0}\left(\frac{\text{TAN}(P \cdot X) - \text{SIN}(P \cdot X)}{\text{TAN}(Q \cdot X) - \text{SIN}(Q \cdot X)}\right)$$

gives:

$$\frac{P^3}{Q^3} + \frac{P^5 - Q^2 \cdot P^3}{4 \cdot Q^3} \cdot x^2$$

**Note**

'th-order' means that the numerator and the denominator are expanded to the 4th relative order (here, the 5th absolute order for the numerator, and for the denominator, which is given in the end, the 2nd order (5-3), seeing that the exponent of the denominator is 3).

**TRUNC**

**Truncate at order n - 1**

TRUNC enables you to truncate a polynomial at a given order (used to perform limited expansions).

TRUNC has two arguments: a polynomial and  $X^n$ .

TRUNC returns the polynomial truncated at order  $n-1$ ; that is, the returned polynomial has no terms with exponents  $\geq n$ .

Typing:

$$\text{TRUNC}\left(\left(1 + X + \frac{1}{2} \cdot X^2\right)^3, X^4\right)$$

gives:

$$4x^3 + \frac{9}{2}x^2 + 3x + 1$$

**REWRI menu**

The REWRI menu contains functions that enable you to rewrite an expression in another form.

**DISTRIB**

**Distributivity of multiplication**

DISTRIB enables you to apply the distributivity of multiplication in respect to addition in a single instance.

DISTRIB enables you, when you apply it several times, to carry out the distributivity step by step.

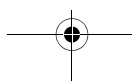
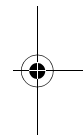
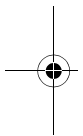



Typing:

```
DISTRIB ( (X+1) * (X+2) * (X+3) )
```

gives:

```
x * (x + 2) * (x + 3) + 1 * (x + 2) * (x + 3)
```

## EPSX0

### Disregard small values

EPSX0 has as a parameter an expression in X, and returns the same expression with the values less than EPS replaced by zeroes.

Typing:

```
EPSX0 (0.001 + X)
```

gives, if EPS=0.01:

```
0 + x
```

or, if EPS=0.0001:

```
.001 + x
```

## EXPLN

### Transform a trigonometric expression into complex exponentials

EXPLN takes as an argument a trigonometric expression. It transforms the trigonometric function into exponentials and logarithms without linearizing it.

EXPLN puts the calculator into complex mode.

Typing:

```
EXPLN ( SIN ( X ) )
```

gives:

$$\frac{\exp(i \cdot x) - \frac{1}{\exp(i \cdot x)}}{2 \cdot i}$$

## EXP2POW

### Transform $\exp(n \cdot \ln(x))$ as a power of x

EXP2POW transforms an expression of the form  $\exp(n \times \ln(x))$ , rewriting it as a power of x.

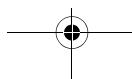
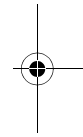
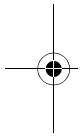

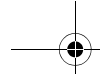

Typing:

```
EXP2POW ( EXP ( N * LN ( X ) ) )
```

gives:

$$x^n$$

## FDISTRIB

### Distributivity

FDISTRIB has an expression as argument.

FDISTRIB enables you to apply the distributivity of multiplication with respect to addition all at once.

Typing:

```
FDISTRIB ( ( X+1 ) * ( X+2 ) * ( X+3 ) )
```

gives:

$$x \cdot x \cdot x + 3 \cdot x \cdot x + x \cdot 2 \cdot x + 3 \cdot 2 \cdot x + x \cdot x \cdot 1 + 3 \cdot x \cdot 1 + x \cdot 2 \cdot 1 + 3 \cdot 2 \cdot 1$$

After simplification (by pressing ENTER):

$$x^3 + 6 \cdot x^2 + 11 \cdot x + 6$$

## LIN

### Linearize the exponentials

LIN has as an argument an expression containing exponentials and trigonometric functions. LIN does not linearize trigonometric expressions (as does TLIN) but converts a trigonometric expression to exponentials and then linearizes the complex exponentials.

LIN puts the calculator into complex mode when dealing with trigonometric functions.

### Example 1

Typing:

```
LIN ( ( EXP ( X ) + 1 ) ^ 3 )
```

gives:

$$3 \cdot \exp(x) + 1 + 3 \cdot \exp(2 \cdot x) + \exp(3 \cdot x)$$

### Example 2

Typing:

```
LIN ( COS ( X ) ^ 2 )
```

gives:

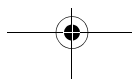
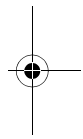
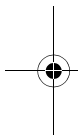



$$\frac{1}{4} \cdot \exp(-2 \cdot i \cdot x) + \frac{1}{2} + \frac{1}{4} \cdot \exp(2 \cdot i \cdot x)$$

**Example 3**

Typing:

LIN(SIN(X))

gives:

$$-\frac{i}{2} \cdot \exp i \cdot x + \frac{i}{2} \cdot \exp(-i \cdot x)$$

**LNCOLLECT****Regroup the logarithms**

LNCOLLECT has as an argument an expression containing logarithms.

LNCOLLECT regroups the terms in the logarithms. It is therefore preferable to use an expression that has already been factored (using FACTOR).

Typing:

LNCOLLECT(LN(X+1)+LN(X-1))

gives:

ln((x+1)(x-1))

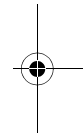
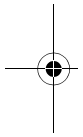
**POWEXPAND****Transform a power**

POWEXPAND writes a power in the form of a product.

Typing:

POWEXPAND((X+1)<sup>3</sup>)

gives:

(x+1) · (x+1) · (x+1)

This allows you to do the development of (x + 1)<sup>3</sup> in step by step, using DISTRIB several times on the preceding result.**SINCOS****Transform the complex exponentials into sin and cos**

SINCOS takes as an argument an expression containing complex exponentials.

SINCOS then rewrites this expression in terms of sin(x) and cos(x).

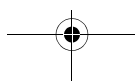

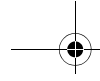

Typing:

$\text{SINCOS}(\text{EXP}(i \cdot X))$

gives after turning on complex mode, if necessary:

$\cos(x) + i \cdot \sin(x)$

## SIMPLIFY

### Simplify

SIMPLIFY simplifies an expression automatically.

Typing:

$\text{SIMPLIFY}\left(\frac{\text{SIN}(3 \cdot X) + \text{SIN}(7 \cdot X)}{\text{SIN}(5 \cdot X)}\right)$

gives, after simplification:

$4 \cdot \cos(x)^2 - 2$

## XNUM

### Evaluation of reals

XNUM has an expression as a parameter.

XNUM puts the calculator into approximate mode and returns the numeric value of the expression.

Typing:

$\text{XNUM}(\sqrt{2})$

gives:

1.41421356237

## XQ

### Rational approximation

XQ has a real numeric expression as a parameter.

XQ puts the calculator into exact mode and gives a rational or real approximation of the expression.

Typing:

$\text{XQ}(1.41421)$

gives:

$\frac{66441}{46981}$

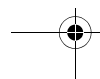
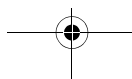
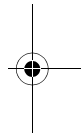
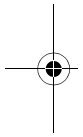



Typing:

XQ(1.414213562)

gives:

$\sqrt{2}$

## SOLV menu

The SOLV menu contains functions that enable you to solve equations, linear systems, and differential equations.

### DESOLVE

#### Solve differential equations

DESOLVE enables you to solve differential equations. (For linear differential equations having constant coefficients, it is better to use LDEC.)

DESOLVE has two arguments:

1. the differential equation where  $y'$  is written as  $d1Y(X)$  (or the differential equation and the initial conditions separated by AND),
2. the unknown  $Y(X)$ .

The mode must be set to real.

#### Example 1

Solve:

$$y'' + y = \cos(x)$$

$$y(0) = cC0 \quad y'(0) = cC1$$

Typing:

DESOLVE(d1d1Y(X)+Y(X) = COS(X), Y(X))

gives:

$$Y(X) = cC0 \cdot \cos(x) + \frac{x+2 \cdot cC1}{2} \cdot \sin(x)$$

$cC0$  and  $cC1$  are integration constants ( $y(0) = cC0$   $y'(0) = cC1$ ).

You can then assign values to the constants using the SUBST command.

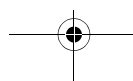
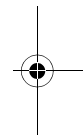
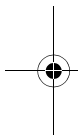

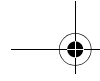

To produce the solutions for  $y(0) = 1$ , type:

$$\text{SUBST}(Y(X) = cC0 \cdot \text{COS}(X) + \frac{X + 2 \cdot cC1}{2} \cdot \text{SIN}(X), cC0 = 1)$$

which gives:

$$y(x) = \frac{2 \cdot \cos(x) + (x + 2 \cdot cC1) \cdot \sin(x)}{2}$$

### Example 2

Solve:

$$y'' + y = \cos(x)$$

$$y(0) = 1 \quad y'(0) = 1$$

It is possible to solve for the constants from the outset.

Typing:

$$\text{DESOLVE}((d1d1Y(X) + Y(X) = \text{COS}(X)) \text{ AND } (Y(0) = 1) \text{ AND } (d1Y(0) = 1), Y(X))$$

gives:

$$Y(x) = \cos x + \frac{2+x}{2} \cdot \sin(x)$$

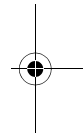
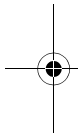

## ISOLATE

### The zeros of an expression

ISOLATE returns the values that are the zeros of an expression or an equation.

ISOLATE has two parameters: an expression or equation, and the name of the variable to isolate (ignoring REALASSUME).

Typing:

$$\text{ISOLATE}(X^4 - 1 = 3, X)$$

gives in real mode:

$$(x = \sqrt{2}) \text{ OR } (x = -\sqrt{2})$$

and in complex mode:

$$(x = \sqrt{2} \cdot i) \text{ OR } (x = -\sqrt{2}) \text{ OR} \\ (x = -(\sqrt{2} \cdot i)) \text{ OR } (x = \sqrt{2})$$

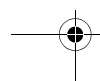
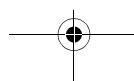



**LDEC****Linear differential equations having constant coefficients**

LDEC enables you to directly solve linear differential equations having constant coefficients.

The parameters are the second member and the characteristic equation.

Solve:

$$y'' - 6 \cdot y' + 9 \cdot y = x \cdot e^{3 \cdot x}$$

Typing:

LDEC (X·EXP (3·X) , X<sup>2</sup>-6·X+9)

gives:

$$\left( \frac{(18 \cdot x - 6) \cdot cC0 - (6 \cdot x \cdot cC1 + x^3)}{6} \right) \cdot \exp(3 \cdot x)$$

cC0 and cC1 are integration constants ( $y(0) = cC0$  and  $y'(0) = cC1$ ).

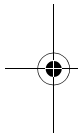
**LINSOLVE****Solve linear system**

LINSOLVE enables you to solve a system of linear equations.

It is assumed that the various equations are of the form expression = 0.

LINSOLVE has two arguments: the first members of the various equations separated by AND, and the names of the various variables separated by AND.

**Example 1**

Typing:

LINSOLVE (X+Y+3 AND X-Y+1, X AND Y)

gives:

$$(x = -2) \text{ AND } (y = -1)$$

or, in Step-by-step mode (CFG, etc.):

L2=L2-L1

$$\begin{bmatrix} 1 & 1 & 3 \\ 1 & -1 & 1 \end{bmatrix}$$

ENTER

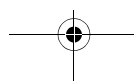

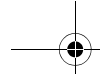

$$L1=2L1+L2$$

$$\begin{bmatrix} 1 & 1 & 3 \\ 0 & -2 & -2 \end{bmatrix}$$

ENTER

Reduction Result

$$\begin{bmatrix} 2 & 0 & 4 \\ 0 & -2 & -2 \end{bmatrix}$$

then press ENTER. The following is then written to the Equation Writer:

$$(x = -2) \text{ AND } (y = -1)$$

### Example 2

Type:

$$(2 \cdot X+Y+Z=1) \text{ AND } (X+Y+2 \cdot Z=1) \text{ AND } (X+2 \cdot Y+Z=4)$$

Then, invoke LINSOLVE and type the unknowns:

$$X \text{ AND } Y \text{ AND } Z$$

and press the ENTER key.

The following result is produced if you are in Step-by-step mode (CFG, etc.):

$$L2=2L2-L1$$

$$\begin{bmatrix} 2 & 1 & 1 & -1 \\ 1 & 1 & 2 & -1 \\ 1 & 2 & 1 & -4 \end{bmatrix}$$

ENTER

$$L3=2L3-L1$$

$$\begin{bmatrix} 2 & 1 & 1 & -1 \\ 0 & 1 & 3 & -1 \\ 1 & 2 & 1 & -4 \end{bmatrix}$$

and so on until, finally:

Reduction Result

$$\begin{bmatrix} 8 & 0 & 0 & 4 \\ 0 & 8 & 0 & -20 \\ 0 & 0 & -8 & -4 \end{bmatrix}$$

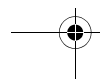
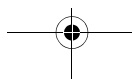
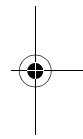
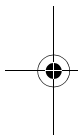



then press ENTER. The following is then written to the Equation Writer:

$$\left(x = -\frac{1}{2}\right) \text{ AND } \left(y = \frac{5}{2}\right) \text{ AND } \left(z = -\frac{1}{2}\right)$$

## SOLVE

### Solve equations

SOLVE has as two parameters:

- (1) either an equality between two expressions, or a single expression (in which case = 0 is implied), and
- (2) the name of a variable.

SOLVE solves the equation in R in real mode and in C in complex mode (ignoring REALASSUME).

Typing:

$$\text{SOLVE}(X^4-1=3, X)$$

gives, in real mode:

$$(x = -\sqrt{2}) \text{ OR } (x = \sqrt{2})$$

or, in complex mode:

$$(x = -\sqrt{2}) \text{ OR } (x = \sqrt{2}) \text{ OR } (x = -i \cdot \sqrt{2}) \text{ OR } (x = i\sqrt{2})$$

### Solve systems

SOLVE also enables you to solve a system of non-linear equations, if they are polynomials. (If they are not polynomials, use MSOLV in the HOME screen to get a numerical solution.)

It is assumed that the various equations are of the form expression = 0.

SOLVE has as arguments, the first members of the various equations separated by AND, and the names of the various variables separated by AND.

Typing:

$$\text{SOLVE}(X^2+Y^2-3 \text{ AND } X-Y^2+1, X \text{ AND } Y)$$

gives:

$$(x = 1) \text{ AND } (y = -\sqrt{2}) \text{ OR } (x = 1) \text{ AND } (y = \sqrt{2})$$

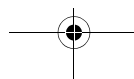
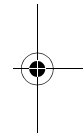
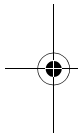

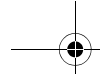

## SOLVEVX

### Solve equations

SOLVEVX has as a parameter either:

(1) an equality between two expressions in the variable contained in VX, or

(2) a single such expression (in which case = 0 is implied).

SOLVEVX solves the equation.

#### Example 1

Typing:

```
SOLVEVX (X4-1=3)
```

gives, in real mode:

(x = -√2) OR (x = √2)

or, in complex mode, even if you have chosen X as real:

(x = -√2) OR (x = √2) OR (x = -i · √2) OR (x = i√2)

#### Example 2

Typing:

```
SOLVEVX (2X2+X)
```

gives, in real mode:

(x = -1/2) OR (x = 0)

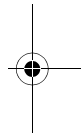
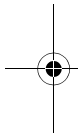

## TRIG menu

The TRIG menu contains functions that enable you to transform trigonometric expressions.

### ACOS2S

#### Transform the arccos into arcsin

ACOS2S has as a trigonometric expression as an argument.

ACOS2S transforms the expression by replacing

$\arccos(x)$  with  $\frac{\pi}{2} - \arcsin(x)$ .

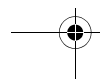
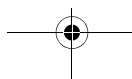



Typing:

ACOS2S ( ACOS ( X ) + ASIN ( X ) )

gives, when simplified:

$$\frac{\pi}{2}$$

### ASIN2C

#### Transform the arcsin into arccos

ASIN2C has as a trigonometric expression as an argument.

ASIN2C transforms the expression by replacing arcsin(x) with  $\frac{\pi}{2} - \arccos(x)$ .

Typing:

ASIN2C ( ACOS ( X ) + ASIN ( X ) )

gives, when simplified:

$$\frac{\pi}{2}$$

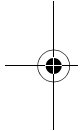

### ASIN2T

#### Transform the arccos into arctan

ASIN2T has a trigonometric expression as an argument.

ASIN2T transforms the expression by replacing arcsin(x) with  $\arctan\left(\frac{x}{\sqrt{1-x^2}}\right)$

Typing:

ASIN2T ( ASIN ( X ) )

gives:

$$\operatorname{atan}\left(\frac{x}{\sqrt{1-x^2}}\right)$$

### ATAN2S

#### Transform the arctan into arcsin

ATAN2S has a trigonometric expression as an argument.

ATAN2S transforms the expression by replacing

arctan(x) with  $\arcsin\left(\frac{x}{\sqrt{1+x^2}}\right)$ .

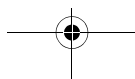

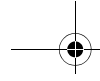

Typing:

ATAN2S ( ATAN ( X ) )

gives:

$$\text{asin}\left(\frac{x}{\sqrt{x^2 + 1}}\right)$$

## HALFTAN

### Transform in terms of $\tan(x/2)$

HALFTAN has a trigonometric expression as an argument.

HALFTAN transforms  $\sin(x)$ ,  $\cos(x)$  and  $\tan(x)$  in the expression, rewriting them in terms of  $\tan(x/2)$ .

Typing:

HALFTAN ( SIN ( X ) <sup>2</sup> + COS ( X ) <sup>2</sup> )

gives (SQ(X) = X<sup>2</sup>):

$$\left(\frac{2 \cdot \tan\left(\frac{x}{2}\right)}{\text{SQ}\left(\tan\left(\frac{x}{2}\right)\right) + 1}\right)^2 + \left(\frac{1 - \text{SQ}\left(\tan\left(\frac{x}{2}\right)\right)}{\text{SQ}\left(\tan\left(\frac{x}{2}\right)\right) + 1}\right)^2$$

or, after simplification:

1

## SINCOS

### Transform the complex exponentials into sin and cos

SINCOS takes an expression containing complex exponentials as an argument.

SINCOS then rewrites this expression in terms of  $\sin(x)$  and  $\cos(x)$ .

Typing:

SINCOS ( EXP ( i · X ) )

gives after turning on complex mode, if necessary:

$$\cos(x) + i \cdot \sin(x)$$

## TAN2CS2

### Transform $\tan(x)$ with $\sin(2x)$ and $\cos(2x)$

TAN2CS2 has a trigonometric expression as an argument.

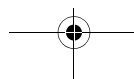



TAN2CS2 transforms this expression by replacing  $\tan(x)$  with  $\frac{1 - \cos(2 \cdot x)}{\sin(2 \cdot x)}$ .

Typing:

TAN2CS2 ( TAN ( X ) )

gives:

$$\frac{1 - \cos(2 \cdot x)}{\sin(2 \cdot x)}$$

### TAN2SC

#### Replace $\tan(x)$ with $\sin(x)/\cos(x)$

TAN2SC has a trigonometric expression as an argument.

TAN2SC transforms this expression by replacing  $\tan(x)$  with  $\frac{\sin(x)}{\cos(x)}$ .

Typing:

TAN2SC ( TAN ( X ) )

gives:

$$\frac{\sin(x)}{\cos(x)}$$

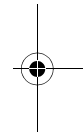
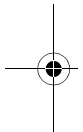

### TAN2SC2

#### Transform $\tan(x)$ with $\sin(2x)$ and $\cos(2x)$

TAN2SC2 has a trigonometric expression as an argument.

TAN2SC2 transforms this expression by replacing  $\tan(x)$  with  $\frac{\sin(2 \cdot x)}{1 + \cos(2 \cdot x)}$ .

Typing:

TAN2SC2 ( TAN ( X ) )

gives:

$$\frac{\sin(2 \cdot x)}{1 + \cos(2 \cdot x)}$$

### TCOLLECT

#### Reconstruct the sine and the cosine of the same angle

TCOLLECT has a trigonometric expression as an argument.

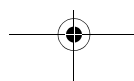

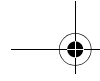

TCOLLECT linearizes this expression in terms of  $\sin(n x)$  and  $\cos(n x)$ , then (in Real mode) reconstructs the sine and cosine of the same angle.

Typing:

`TCOLLECT ( SIN ( X ) + COS ( X ) )`

gives:

$$\sqrt{2} \cdot \cos\left(x - \frac{\pi}{4}\right)$$

## TEXPAND

### Develop transcendental expressions

TEXPAND has as an argument a transcendental expression (that is, an expression with trigonometric, exponential or logarithmic functions). TEXPAND develops this expression in terms of  $\sin(x)$ ,  $\cos(x)$ ,  $\exp(x)$  or  $\ln(x)$ .

#### Example 1

Typing:

`TEXPAND ( EXP ( X+Y ) )`

gives:

$$\exp(x) \cdot \exp(y)$$

#### Example 2

Typing:

`TEXPAND ( LN ( X · Y ) )`

gives:

$$\ln(y) + \ln(x)$$

#### Example 3

Typing:

`TEXPAND ( COS ( X+Y ) )`

gives:

$$\cos(y) \cdot \cos(x) - \sin(y) \cdot \sin(x)$$

#### Example 4

Typing:

`TEXPAND ( COS ( 3 · X ) )`

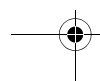
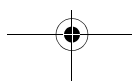
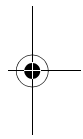
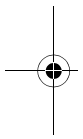



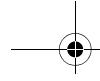

gives:

$$4 \cdot \cos(x)^3 - 3 \cdot \cos(x)$$

## TLIN

### Linearize a trigonometric expression

TLIN has as an argument a trigonometric expression.

TLIN linearizes this expression in terms of  $\sin(n \cdot x)$  and  $\cos(n \cdot x)$ .

#### Example 1

Typing:

$$\text{TLIN}(\cos(X) \cdot \cos(Y))$$

gives:

$$\frac{1}{2} \cdot \cos(x - y) + \frac{1}{2} \cdot \cos(x + y)$$

#### Example 2

Typing:

$$\text{TLIN}(\cos(X)^3)$$

gives:

$$\frac{1}{4} \cdot \cos(3 \cdot x) + \frac{3}{4} \cdot \cos(x)$$

#### Example 3

Typing:

$$\text{TLIN}(4 \cdot \cos(X)^2 - 2)$$

gives:

$$2 \cdot \cos(2 \cdot x)$$

## TRIG

### Simplify using $\sin(x)^2 + \cos(x)^2 = 1$

TRIG has as an argument a trigonometric expression.

TRIG simplifies this expression using the identity  $\sin(x)^2 + \cos(x)^2 = 1$ .

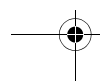
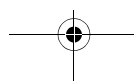
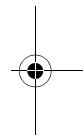
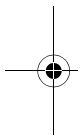

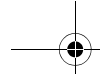

Typing:

$$\text{TRIG}(\text{SIN}(X)^2 + \text{COS}(X)^2 + 1)$$

gives:

$$2$$

### TRIGCOS

#### Simplify using the cosines

TRIGCOS has as an argument a trigonometric expression.

TRIGCOS simplifies this expression, using the identity  $\sin(x)^2 + \cos(x)^2 = 1$  to rewrite it in terms of cosines.

Typing:

$$\text{TRIGCOS}(\text{SIN}(X)^4 + \text{COS}(X)^2 + 1)$$

gives:

$$\cos(x)^4 - \cos(x)^2 + 2$$

### TRIGSIN

#### Simplify using the sines

TRIGSIN has as an argument a trigonometric expression.

TRIGSIN simplifies this expression, using the identity  $\sin(x)^2 + \cos(x)^2 = 1$  to rewrite it in terms of sines.

Typing:

$$\text{TRIGSIN}(\text{SIN}(X)^4 + \text{COS}(X)^2 + 1)$$

gives:

$$\sin(x)^4 - \sin(x)^2 + 2$$

### TRIGTAN

#### Simplify using the tangents

TRIGTAN has as an argument a trigonometric expression.

TRIGTAN simplifies this expression, using the identity  $\sin(x)^2 + \cos(x)^2 = 1$  to rewrite it in terms of tangents.

Typing:

$$\text{TRIGTAN}(\text{SIN}(X)^4 + \text{COS}(X)^2 + 1)$$

gives:

$$\frac{2 \cdot \tan(x)^4 + 3 \cdot \tan(x)^2 + 2}{\tan(x)^4 + 2 \cdot \tan(x)^2 + 1}$$

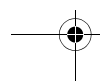
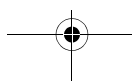



## CAS Functions on the MATH menu

When you are in the Equation Writer and press  $\boxed{\text{MATH}}$ , a menu of additional CAS functions available to you is displayed. Many of the functions in this menu match the functions available from the soft-key menus in the Equation Writer; but there are other functions that are only available from this menu. This section describes CAS functions that are available when you press  $\boxed{\text{MATH}}$  in the Equation Writer (grouped by main menu name).



### Algebra menu

All the functions on this menu are also available on the  $\boxed{\text{ALGB}}$  menu in the Equation Writer. See "ALGB menu" on page 14-10 for a description of these functions.

### Complex menu

- i** Inserts  $i (= \sqrt{-1})$ .
- ABS** Determines the absolute value of the argument.  
**Example**  
Typing  $\text{ABS}(7 + 4i)$  yields  $\sqrt{65}$ , as does  $\text{ABS}(7 - 4i)$ .
- ARG** See "ARG" on page 13-7.
- CONJ** See "CONJ" on page 13-7.
- DROITE** DROITE returns the equation of the line through the Cartesian points,  $z_1, z_2$ . It takes two complex numbers,  $z_1$  and  $z_2$ , as arguments.

**Example**

Typing:

$\text{DROITE}((1, 2), (0, 1))$

or:

$\text{DROITE}(1 + 2 \cdot i, i)$

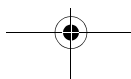



returns:

$$Y = X - 1 + 2$$

Pressing **ENTER** simplifies this to:

$$Y = X + 1$$

### IM

See "IM" on page 13-7.

-

Specifies the negation of the argument.

### RE

See "RE" on page 13-8.

### SIGN

Determines the quotient of the argument divided by its modulus.

#### Example

Typing SIGN(7 + 4i) or SIGN(7,4) yields  $\frac{7 + 4i}{\sqrt{65}}$ .

## Constant menu

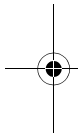

e, i, π

See "Constants" on page 13-8.

∞

Enters the sign for infinity.

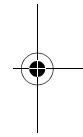

## Diff & Int menu

All the functions on this menu are also available on the **DIFF** menu in the Equation Writer. See "DIFF menu" on page 14-16 for a description of these functions.

## Hyperb menu

All the functions on this menu are described in "Hyperbolic trigonometry" on page 13-9.

## Integer menu

Note that many integer functions also work with Gaussian integers ( $a + bi$  where  $a$  and  $b$  are integers).

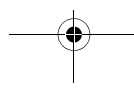

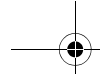

## DIVIS

Gives the divisors of an integer.

### Example

Typing:

DIVIS(12)

gives:

12 OR 6 OR 3 OR 4 OR 2 OR 1

Note: DIVIS(0) returns 0 OR 1.

## EULER

Returns the Euler index of a whole number. The Euler index of  $n$  is the number of whole numbers less than  $n$  that are prime with  $n$ .

### Example

Typing:

EULER(21)

gives:

12

**Explanation:** {2,4,5,7,8,10,11,13,15,16,17,19} is the set of whole numbers less than 21 and prime with 21. There are 12 members of the set, so the Euler index is 12.

## FACTOR

Decomposes an integer into its prime factors.

### Example

Typing:

FACTOR(90)

gives:

$2 \cdot 3^2 \cdot 5$

## GCD

Returns the *greatest common divisor* of two integers.

### Example

Typing:

GCD(18, 15)

gives:

3

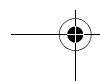
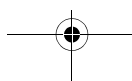

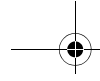

In step-by-step mode, there are a number of intermediate results:

$$18 \bmod 15 = 3$$

$$15 \bmod 3 = 0$$

Result: 3

Pressing  $\boxed{\text{ENTER}}$  or  $\boxed{\text{=}}$  then causes 3 to be written to the Equation Writer.

Note that the last non-zero remainder in the sequence of remainders shown in the intermediate steps is the GCD.

## IDIV2

Returns the quotient and the remainder of the Euclidean division between two integers.

### Example

Typing:

IDIV2(148, 5)

gives:

29 AND 3

In step-by-step mode, the calculator shows the division process in longhand.

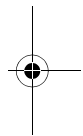
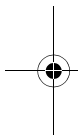
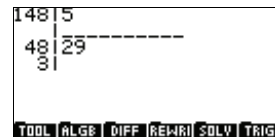

## IEGCD

Returns the value of Bézout's Identity for two integers. For example, IEGCD(A,B) returns U AND V = D, with U, V, D such that  $AU + BV = D$  and  $D = \text{GCD}(A, B)$ .

### Example

Typing:

IEGCD(48, 30)

gives

2 AND -3 = 6

In other words:  $2 \cdot 48 + (-3) \cdot 30 = 6$  and  $\text{GCD}(48, 30) = 6$ .

In step-by-step mode, we get:

[z,u,v]:z=u\*48+v\*30

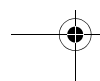
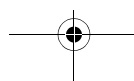



[48,1,0]  
 [30,0,1]\*-1  
 [18,1,-1]\*-1  
 [12,-1,2]\*-1  
 [6,2,-3]\*-2  
 Result: [6,2,-3]

Pressing **ENTER** or **2ND** then causes 2 AND  $-3 = 6$  to be written to the Equation Writer.

The intermediate steps shown are the combination of lines. For example, to get line  $L(n + 2)$ , take  $L(n) - q * L(n + 1)$  where  $q$  is the Euclidean quotient of the integers at the beginning of the vector, these integers being the sequence of remainders).

## IQUOT

Returns the integer quotient of the Euclidean division of two integers.

### Example

Typing:

IQUOT(148, 5)

gives:

29

In step-by-step mode, the division is carried out as if in longhand

Pressing **ENTER** or **2ND** then causes 29 to be written to the Equation Writer.

## IREMAINDER

Returns the integer remainder from the Euclidean division of two integers.

### Example 1

Typing:

IREMAINDER(148, 5)

gives:

3

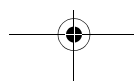

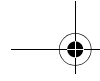

Iremainder works with integers and with Gaussian integers. This is what distinguishes it from MOD.

**Example 2**

Typing:

```
Iremainder(2 + 3·i, 1 + i)
```

gives:

i

**ISPRIME?**

Returns a value indicating whether an integer is a prime number. ISPRIME?(n) returns 1 (TRUE) if n is a prime or pseudo-prime, and 0 (FALSE) if n is not prime.

**Definition:** For numbers less than 10<sup>14</sup>, pseudo-prime and prime mean the same thing. For numbers greater than 10<sup>14</sup>, a pseudo-prime is a number with a large probability of being prime.

**Example 1**

Typing:

```
ISPRIME?(13)
```

gives:

1.

**Example 2**

Typing:

```
ISPRIME?(14)
```

gives:

0.

**LCM**

Returns the *least common multiple* of two integers.

**Example**

Typing:

```
LCM(18, 15)
```

gives:

90

**MOD**

See "MOD" on page 13-15.

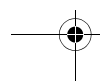
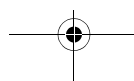
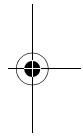
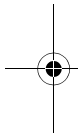



**NEXTPRIME**

NEXTPRIME( $n$ ) returns the smallest prime or pseudo-prime greater than  $n$ .

**Example**

Typing:

```
NEXTPRIME(75)
```

gives:

```
79
```

**PREVPRIME**

PREVPRIME( $n$ ) returns the greatest prime or pseudo-prime less than  $n$ .

**Example**

Typing:

```
PREVPRIME(75)
```

gives:

```
73
```

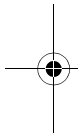
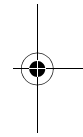
**Modular menu**

All the examples of this section assume that  $p = 13$ ; that is, you have entered MODSTO(13) or STORE(13,MODULO), or have specified 13 for Modulo in CAS MODES screen (as explained on page 15-16).

**ADDTMOD**

Performs an addition in  $Z/pZ$ .

**Example 1**

Typing:

```
ADDTMOD(2, 18)
```

gives:

```
-6
```

ADDTMOD can also perform addition in  $Z/pZ[X]$ .

**Example 2**

Typing:

```
ADDTMOD(11X + 5, 8X + 6)
```

gives:

```
6x - 2
```

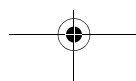

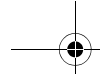
**DIVMOD**Division in  $Z/pZ$  or  $Z/pZ[X]$ .**Example 1**

In  $Z/pZ$ , the arguments are two integers: A and B. When B has an inverse in  $Z/pZ$ , the result is  $A/B$  simplified as  $Z/pZ$ .

Typing:

$$\text{DIVMOD}(5, 3)$$

gives:

$$6$$
**Example 2**

In  $Z/pZ[X]$ , the arguments are two polynomials:  $A[X]$  and  $B[X]$ . The result is a rational fraction  $A[X]/B[X]$  simplified as  $Z/pZ[X]$ .

Typing:

$$\text{DIVMOD}(2X^2 + 5, 5X^2 + 2X - 3)$$

gives:

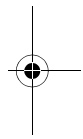
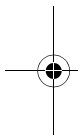
$$\frac{4x + 5}{3x + 3}$$
**EXPANDMOD**Expand and simplify expressions in  $Z/pZ$  or  $Z/pZ[X]$ .**Example 1**

In  $Z/pZ$ , the argument is an integer expression.

Typing:

$$\text{EXPANDMOD}(2 \cdot 3 + 5 \cdot 4)$$

gives:

$$0$$
**Example 2**

In  $Z/pZ[X]$ , the argument is a polynomial.

Typing:

$$\text{EXPANDMOD}((2X^2 + 12) \cdot (5X - 4))$$

gives:

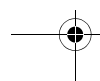
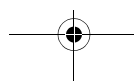
$$-(3 \cdot x^3 - 5 \cdot x^2 + 5 \cdot x - 4)$$

**FACTORMOD**

Factors a polynomial in  $Z/pZ[X]$ , providing that  $p \leq 97$ ,  $p$  is prime and the order of the multiple factors is less than the modulo.

**Example**

Typing:

```
FACTORMOD(-(3X3 - 5X2 + 5X - 4))
```

gives:

$$-((3x - 5) \cdot (x^2 + 6))$$
**GCDMOD**

Calculates the GCD of the two polynomials in  $Z/pZ[X]$ .

**Example**

Typing:

```
GCDMOD(2X2 + 5, 5X2 + 2X - 3)
```

gives:

$$-(6x - 1)$$
**INVMOD**

Calculates the inverse of an integer in  $Z/pZ$ .

**Example**

Typing:

```
INVMOD(5)
```

gives:

$$-5$$

since  $5 \cdot -5 = -25 = 1 \pmod{13}$ .

**MODSTO**

Sets the value of the MODULO variable  $p$ .

**Example**

Typing:

```
MODSTO(11)
```

sets the value of  $p$  to 11.

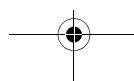
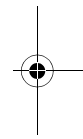
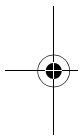

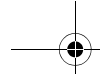
**MULTMOD**Performs a multiplication in  $Z/pZ$  or in  $Z/pZ[X]$ .**Example 1**

Typing:

MULTMOD(11, 8)

gives:

-3

**Example 2**

Typing:

MULTMOD(11X + 5, 8X + 6)

gives:

 $-(3x^2 - 2x - 4)$ **POWMOD**Calculates A to the power of N in  $Z/pZ[X]$ , and A(X) to the power of N in  $Z/pZ[X]$ .**Example 1**If  $p = 13$ , typing:

POWMOD(11, 195)

gives:

5

In effect:  $11^{12} = 1 \pmod{13}$ , so  $11^{195} = 11^{16 \times 12 + 3} = 5 \pmod{13}$ .**Example 2**

Typing:

POWMOD(2X + 1, 5)

gives:

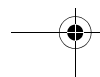
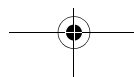
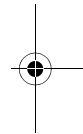
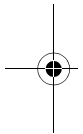
 $6x^5 + 2x^4 + 2x^3 + x^2 - 3x + 1$ since  $32 = 6 \pmod{13}$ ,  $80 = 2 \pmod{13}$ ,  $40 = 1 \pmod{13}$ ,  $10 = -3 \pmod{13}$ .

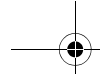
**SUBTMOD**Performs a subtraction in  $Z/pZ$  or  $Z/pZ[X]$ .**Example 1**

Typing:

SUBTMOD(29, 8)

gives:

-5

**Example 2**

Typing:

SUBTMOD(11X + 5, 8X + 6)

gives:

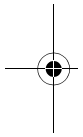
 $3x - 1$ **Polynomial menu****EGCD**

Returns Bézout's Identity, the Extended Greatest Common Divisor (EGCD).

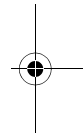
EGCD(A(X), B(X)) returns U(X) AND V(X) = D(X), with D, U, V such that  $D(X) = U(X) \cdot A(X) + V(X) \cdot B(X)$ .**Example 1**

Typing:

EGCD( $X^2 + 2 \cdot X + 1$ ,  $X^2 - 1$ )

gives:

-1 AND  $-1 = 2x + 2$ **Example 2**

Typing:

EGCD( $X^2 + 2 \cdot X + 1$ ,  $X^3 + 1$ )

gives:

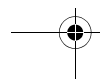
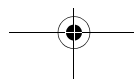
 $-(x - 2)$  AND  $1 = 3x + 3$ 

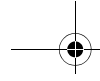
**FACTOR**

Factors a polynomial.

**Example 1**

Typing:

FACTOR( $X^2 - 2$ )

gives:

 $(x + \sqrt{2}) \cdot (x - \sqrt{2})$ **Example 2**

Typing:

FACTOR( $X^2 + 2 \cdot X + 1$ )

gives:

 $(x + 1)^2$ **GCD**

Returns the GCD (Greatest Common Divisor) of two polynomials.

**Example**

Typing:

GCD( $X^2 + 2 \cdot X + 1, X^2 - 1$ )

gives:

 $x + 1$ **HERMITE**Returns the Hermite polynomial of degree  $n$  (where  $n$  is a whole number). This is a polynomial of the following type:

$$H_n(x) = (-1)^n \cdot e^{\frac{x^2}{2}} \frac{d^n}{dx^n} e^{-\frac{x^2}{2}}$$

**Example**

Typing:

HERMITE(6)

gives:

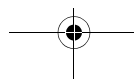
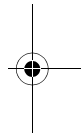
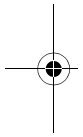
 $64x^6 - 480x^4 + 720x^2 - 120$ 

**LCM**

Returns the LCM (Least Common Multiple) of two polynomials.

**Example**

Typing:

$$\text{LCM}(X^2 + 2 \cdot X + 1, X^2 - 1)$$

gives:

$$(x^2 + 2x + 1) \cdot (x - 1)$$

**LEGENDRE**

Returns the polynomial  $L_n$ , a non-null solution of the differential equation:

$$(x^2 - 1) \cdot y'' - 2 \cdot x \cdot y' - n(n + 1) \cdot y = 0$$

where  $n$  is a whole number.

**Example**

Typing:

$$\text{LEGENDRE}(4)$$

gives:

$$\frac{35 \cdot x^4 - 30 \cdot x^2 + 3}{8}$$

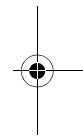
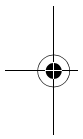
**PARTFRAC**

Returns the partial fraction decomposition of a rational fraction.

**Example**

Typing:

$$\text{PARTFRAC}\left(\frac{X^5 - 2X^3 + 1}{X^4 - 2X^3 + 2X^2 - 2X + 1}\right)$$

gives, in real and direct mode:

$$x + 2 + \frac{x - 3}{2x^2 + 2} + \frac{-1}{2x - 2}$$

and gives, in complex mode:

$$x + 2 + \frac{1 - 3 \cdot i}{4} \cdot \frac{1}{x + i} + \frac{-1}{2} \cdot \frac{1}{x - 1} + \frac{1 + 3 \cdot i}{4} \cdot \frac{1}{x - i}$$

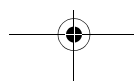

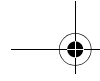
**PROPFAC**

PROPFAC rewrites a rational fraction so as to bring out its whole number part.

PROPFAC(A(X)/ B(X)) writes the rational fraction A(X)/ B(X) in the form:

$$Q(X) + \frac{R(X)}{B(X)}$$

where  $R'(X) = 0$ , or  $0 \leq \text{deg}(R(X)) < \text{deg}(B(X))$ .

**Example**

Typing:

$$\text{PROPFAC}\left(\frac{(5X+3) \cdot (X-1)}{X+2}\right)$$

gives:

$$5x - 12 + \frac{21}{x+2}$$

**PTAYL**

PTAYL rewrites a polynomial P(X) in order of its powers of  $X - a$ .

**Example**

Typing:

$$\text{PTAYL}(X^2 + 2 \cdot X + 1, 2)$$

produces the polynomial Q(X), namely:

$$x^2 + 6x + 9$$

Note that  $P(X) = Q(X-2)$ .

**QUOT**

QUOT returns the quotient of two polynomials, A(X) and B(X), divided in decreasing order by exponent.

**Example**

Typing:

$$\text{QUOT}(X^2 + 2 \cdot X + 1, X)$$

gives:

$$x + 2$$

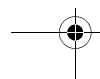
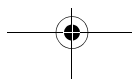
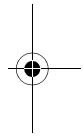
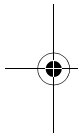



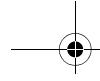

Note that in step-by-step mode, synthetic division is shown, with each polynomial represented as the list of its coefficients in descending order of power.

## REMAINDER

Returns the remainder from the division of the two polynomials, A(X) and B(X), divided in decreasing order by exponent.

### Example

Typing:

REMAINDER( $X^3 - 1$ ,  $X^2 - 1$ )

gives:

$x - 1$

Note that in step-by-step mode, synthetic division is shown, with each polynomial represented as the list of its coefficients in descending order of power.

## TCHEBYCHEFF

For  $n > 0$ , TCHEBYCHEFF returns the polynomial  $T_n$  such that:

$$T_n(x) = \cos(n \cdot \arccos(x))$$

For  $n \geq 0$ , we have:

$$T_n(x) = \sum_{k=0}^{\lfloor \frac{n}{2} \rfloor} C_n^{2k} (x^2 - 1)^k x^{n-2k}$$

For  $n \geq 0$  we also have:

$$(1 - x^2)T_n''(x) - xT_n'(x) + n^2 T_n(x) = 0$$

For  $n \geq 1$ , we have:

$$T_{n+1}(x) = 2xT_n(x) - T_{n-1}(x)$$

If  $n < 0$ , TCHEBYCHEFF returns the 2nd-species Tchebycheff polynomial:

$$T_n(x) = \frac{\sin(n \cdot \arccos(x))}{\sin(\arccos(x))}$$

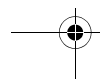
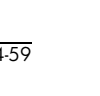
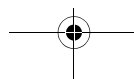
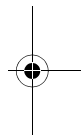
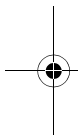



### Example 1

Typing:

TCHEBYCHEFF(4)

gives:

$$8x^4 - 8x^2 + 1$$

### Example 2

Typing:

TCHEBYCHEFF(-4)

gives:

$$8x^3 - 4x$$

## Real menu

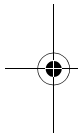

**CEILING**

See "CEILING" on page 13-14.

**FLOOR**

See "FLOOR" on page 13-14.

**FRAC**

See "FRAC" on page 13-14.

**INT**

See "INT" on page 13-15.

**MAX**

See "MAX" on page 13-15.

**MIN**

See "MIN" on page 13-15.

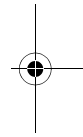

## Rewrite menu

All the functions on this menu are also available on the **REWR** menu in the Equation Writer. See "REWR menu" on page 14-28 for a description of these functions.

## Solve menu

All the functions on this menu are also available on the **SOLV** menu in the Equation Writer. See "SOLV menu" on page 14-33 for a description of these functions.

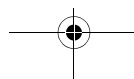



## Tests menu

### ASSUME

Use this function to make a hypothesis about a specified argument or variable.

#### Example

Typing:

ASSUME(X>Y)

sets an assumption that X is greater than Y. In fact, the calculator works only with *large* not *strict* relations, and thus ASSUME(X>Y) will actually set the assumption that  $X \geq Y$ . (A message will indicate this when you enter an ASSUME function.) Note that  $X \geq Y$  will be stored in the REALASSUME variable. To see the variable, press  $\boxed{\text{VARS}}$ , select REALASSUME and press  $\boxed{\text{ENTER}}$ .

### UNASSUME

Use this function to cancel all previously specified assumptions about a particular argument or variable.

#### Example

Typing:

UNASSUME(X)

cancels any assumptions made about X. It returns X in the Equation Writer. To see the assumptions, press  $\boxed{\text{VARS}}$ , select REALASSUME and press  $\boxed{\text{ENTER}}$ .

>, ≥, <, ≤, =, ≠

See "Test functions" on page 13-19.

### AND

See "AND" on page 13-19.

### OR

See "OR" on page 13-19.

### NOT

See "NOT" on page 13-19.

### IFTE

See "IFTE" on page 13-19.

## Trig menu

All the functions on this menu are also available on the  $\boxed{\text{TRIG}}$  menu in the Equation Writer. See "TRIG menu" on page 14-38 for a description of these functions.

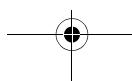
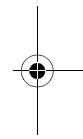
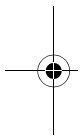

## CAS Functions on the CMDS menu

When you are in the Equation Writer and press  $\boxed{\text{SHIFT}} \boxed{\text{MATH}}$ , a menu of the full set of CAS functions available to you is displayed. Many of the functions in this menu



match the functions available from the soft-key menus in the Equation Writer; but there are other functions that are only available from this menu. This section describes the additional CAS functions that are available when you press  $\boxed{\text{SHIFT}} \boxed{\text{MATH}}$  in the Equation Writer. (See the previous section for other CAS commands.)

### ABCUV

This command applies the Bézout identity like EGCD, but the arguments are three polynomials A, B and C. (C must be a multiple of GCD(A,B).)

ABCUV(A[X], B[X], C[X]) returns U[X] AND V[X], where U and V satisfy:

$$C[X] = U[X] \cdot A[X] + V[X] \cdot B[X]$$

#### Example 1

Typing:

$$\text{ABCUV}(X^2 + 2 \cdot X + 1, X^2 - 1, X + 1)$$

gives:

$$\frac{1}{2} \text{ AND } -\frac{1}{2}$$

### CHINREM

Chinese Remainders: CHINREM has two sets of two polynomials as arguments, each separated by AND.

CHINREM((A(X) AND R(X), B(X) AND Q(X)) returns an AND with two polynomials as components: P(X) and S(X). The polynomials P(X) and S(X) satisfy the following relations when  $\text{GCD}(R(X), Q(X)) = 1$ :

$$S(X) = R(X) \cdot Q(X),$$

$$P(X) = A(X) \pmod{R(X)} \text{ and } P(X) = B(X) \pmod{Q(X)}.$$

There is always a solution, P(X), if R(X) and Q(X) are mutually primes and all solutions are congruent modulo  $S(X) = R(X) \cdot Q(X)$ .

**Example**

Find the solutions P(X) of:

$$P(X) = X \pmod{X^2 + 1}$$

$$P(X) = X - 1 \pmod{X^2 - 1}$$

Typing:

CHINREM((X) AND (X<sup>2</sup> + 1), (X - 1) AND (X<sup>2</sup> - 1))

gives:

$$\frac{x^2 - 2x + 1}{2} \text{ AND } \frac{x^4 - 1}{2}$$

That is:

$$P[X] = \frac{x^2 - 2x + 1}{2} \pmod{\frac{x^4 - 1}{2}}$$

**CYCLOTOMIC**

Returns the cyclotomic polynomial of order  $n$ . This is a polynomial having the  $n$ th primitive roots of unity as zeros.

CYCLOTOMIC has an integer  $n$  as its argument.

**Example 1**

When  $n = 4$  the fourth roots of unity are  $\{1, i, -1, -i\}$ . Among them, the primitive roots are:  $\{i, -i\}$ . Therefore, the cyclotomic polynomial of order 4 is  $(X - i)(X + i) = X^2 + 1$ .

**Example 2**

Typing:

CYCLOTOMIC(20)

gives:

$$x^8 - x^6 + x^4 - x^2 + 1$$

**EXP2HYP**

EXP2HYP has an expression enclosing exponentials as an argument. It transforms that expression with the relation:

$$\exp(a) = \sinh(a) + \cosh(a).$$

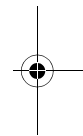
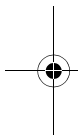



**Example 1**

Typing:

EXP2HYP(EXP(A))

gives:

$\sinh(a) + \cosh(a)$

**Example 2**

Typing:

EXP2HYP(EXP(-A) + EXP(A))

gives:

$2 \cdot \cosh(a)$

**GAMMA**

Returns the values of the  $\Gamma$  function at a given point.

The  $\Gamma$  function is defined as:

$$\Gamma(x) = \int_0^{+\infty} e^{-t} t^{x-1} dt$$

We have:

$$\Gamma(1) = 1$$

$$\Gamma(x + 1) = x \cdot \Gamma(x)$$

**Example 1**

Typing:

GAMMA(5)

gives:

24

**Example 2**

Typing:

GAMMA(1/2)

gives:

$\sqrt{\pi}$

**IABCUV**

IABCUV(A,B,C) returns U AND V such that  $AU + BV = C$  where A, B and C are whole numbers.

C must be a multiple of GCD(A,B) to obtain a solution.

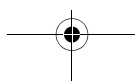
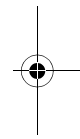
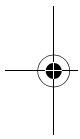

**Example**

Typing:

IABCUV(48, 30, 18)

gives:

6 AND -9

**IBERNOULLI**Returns the  $n$ th Bernoulli's number  $B(n)$  where:

$$\frac{t}{e^t - 1} = \sum_{n=0}^{+\infty} \frac{B(n)}{n!} t^n$$

**Example**

Typing:

IBERNOULLI(6)

gives:

$$\frac{1}{42}$$

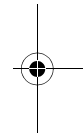
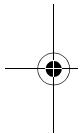
**ICHINREM**

Chinese Remainders: ICHINREM(A AND P,B AND Q) returns C AND R, where A, B, P and Q are whole numbers.

The numbers  $X = C + k \cdot R$  where  $k$  is an integer are such that  $X = A \pmod P$  and  $X = B \pmod Q$ .A solution  $X$  always exists when  $P$  and  $Q$  are mutually prime, ( $\text{GCD}(P,Q) = 1$ ) and in this case, all the solutions are congruent modulo  $R = P \cdot Q$ .**Example**

Typing:

ICHINREM(7 AND 10, 12 AND 15)

gives:

-3 AND 30

**ILAP**

LAP is the Laplace transform of a given expression. The expression is the value of a function of the variable stored in VX.

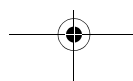

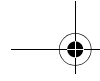

ILAP is the inverse Laplace transform of a given expression. Again, the expression is the value of a function of the variable stored in VX.

Laplace transform (LAP) and inverse Laplace transform (ILAP) are useful in solving linear differential equations with constant coefficients, for example:

$$y'' + p \cdot y' + q \cdot y = f(x)$$

$$y(0) = a \quad y'(0) = b$$

The following relations hold:

$$\text{LAP}(y)(x) = \int_0^{+\infty} e^{-x \cdot t} y(t) dt$$

$$\text{ILAP}(f)(x) = \frac{1}{2i\pi} \cdot \int_c e^{zx} f(z) dz$$

where  $c$  is a closed contour enclosing the poles of  $f$ .

The following property is used:

$$\text{LAP}(y')(x) = -y(0) + x \cdot \text{LAP}(y)(x)$$

The solution,  $y$ , of:

$$y'' + p \cdot y' + q \cdot y = f(x), \quad y(0) = a, \quad y'(0) = b$$

is then:

$$\text{ILAP}\left(\frac{\text{LAP}(f(x)) + (x+p) \cdot a + b}{x^2 + px + q}\right)$$

### Example

To solve:

$$y'' - 6 \cdot y' + 9 \cdot y = x \cdot e^{3x}, \quad y(0) = a, \quad y'(0) = b$$

type:

$$\text{LAP}(X \cdot \text{EXP}(3 \cdot X))$$

The result is:

$$\frac{1}{x^2 - 6x + 9}$$

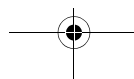
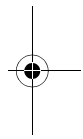
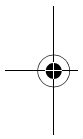





Typing:

$$\text{ILAP} \left( \frac{\frac{1}{X^2 - 6X + 9} + (X-6) \cdot a + b}{X^2 - 6X + 9} \right)$$

gives:

$$\left( \frac{x^3}{6} - (3a - b) \cdot x + a \right) \cdot e^{3x}$$

### LAP

See ILAP above.

### PA2B2

Decomposes a prime integer  $p$  congruent to 1 modulo 4, as follows:

$$p = a^2 + b^2.$$

The calculator gives the result as  $a + b \cdot i$ .

#### Example 1

Typing:

PA2B2(17)

gives:

$$4 + i$$

that is,  $17 = 4^2 + 1^2$

#### Example 2

Typing:

PA2B2(29)

gives:

$$5 + 2 \cdot i$$

that is,  $29 = 5^2 + 2^2$

### PSI

Returns the value of the  $n$ th derivative of the Digamma function at  $a$ .

The Digamma function is the derivative of  $\ln(\Gamma(x))$ .

#### Example

Typing:

PSI(3, 1)

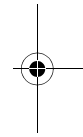
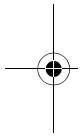



gives:

$$-\frac{5}{4} + \frac{1}{6} \cdot \pi^2$$

## Psi

Returns the value of the Digamma function at  $a$ .

The Digamma function is defined as the derivative of  $\ln(\Gamma(x))$ , so we have  $\text{PSI}(a,0) = \text{Psi}(a)$ .

### Example

Typing:

Psi(3)

and pressing

gives:

.922784335098

## REORDER

Reorders the input expression following the order of variables given in the second argument.

### Example

Typing:

REORDER( $X^2 + 2 \cdot X \cdot A + A^2 + Z^2 - X \cdot Z$ , A AND X AND Z)

gives:

$$A^2 + 2 \cdot X \cdot A + X^2 - Z \cdot X + Z^2$$

## SEVAL

SEVAL simplifies the given expression, operating on all but the top-level operator of the expression.

### Example

Typing:

SEVAL( $\text{SIN}(3 \cdot X - X) + \text{SIN}(X + X)$ )

gives:

$$\sin(2 \cdot x) + \sin(2 \cdot x)$$

## SIGMA

Returns the discrete antiderivative of the input function, that is, the function  $G$ , that satisfies the relation  $G(x + 1) - G(x) = f(x)$ . It has two arguments: the first is a function  $f(x)$  of a variable  $x$  given as the second argument.

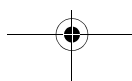

**Example**

Typing:

$$\text{SIGMA}(X \cdot X!, X)$$

gives:

$$X!$$

because  $(X + 1)! - X! = X \cdot X!$ .**SIGMAVX**

Returns the discrete antiderivative of the input function, that is a function,  $G$ , that satisfies the relation:  $G(x + 1) - G(x) = f(x)$ . SIGMAVX has as its argument a function  $f$  of the current variable  $VX$ .

**Example**

Typing:

$$\text{SIGMAVX}(X^2)$$

gives:

$$\frac{2x^3 - 3x^2 + x}{6}$$

because:

$$2(x + 1)^3 - 3(x + 1)^2 + x + 1 - 2x^3 + 3x^2 - x = 6x^2$$

**STURMAB**

Returns the number of zeros of  $P$  in  $[a, b[$  where  $P$  is a polynomial and  $a$  and  $b$  are numbers.

**Example 1**

Typing:

$$\text{STURMAB}(X^2 \cdot (X^3 + 2), -2, 0)$$

gives:

$$1$$

**Example 2**

Typing:

$$\text{STURMAB}(X^2 \cdot (X^3 + 2), -2, 1)$$

gives:

$$3$$

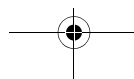
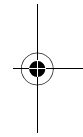
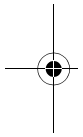

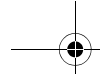

## TSIMP

Simplifies a given expression by rewriting it as a function of complex exponentials, and then reducing the number of variables (enabling complex mode in the process).

### Example

Typing:

$$\text{TSIMP}\left(\frac{\text{SIN}(3X) + \text{SIN}(7X)}{\text{SIN}(5X)}\right)$$

gives:

$$\frac{\text{EXP}(i \cdot x)^4 + 1}{\text{EXP}(i \cdot x)^2}$$

## VER

Returns the version number of your CAS.

### Example

Typing:

VER

might give:

4.20050219

This particular result means that you have a version 4 CAS, dated 19 February 2005. Note that this is not the same as VERSION (which returns the version of the calculator's ROM).

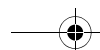
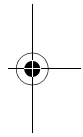
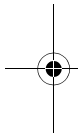

## Equation Writer

### Using CAS in the Equation Writer

The Equation Writer enables you to type expressions that you want to simplify, factor, differentiate, integrate, and so on, and then work them through as if on paper.

The **EQW** key on the HOME screen menu bar opens the Equation Writer, and the **HOME** key closes it.

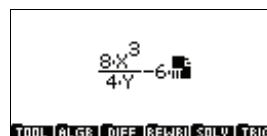

This chapter explains how to write an expression in the Equation Writer using the menus and the keyboard, how to select a subexpression, how to apply CAS functions to an expression or subexpression and how to store values in the Equation Writer variables.

Chapter 14 explains all the symbolic calculation functions contained in the various menus, and chapter 16 provides numerous examples showing the use of the Equation Writer.

### The Equation Writer menu bar

The Equation Writer has a number of soft menu keys.



#### TOOL menu

Unlike the other soft menu keys, the **TOOL** menu does not give access to CAS commands. Instead, it provides access to a number of utilities to help you work with the Equation Writer. The following table explains each of the utilities on the **TOOL** menu.





Cursor mode	Enables you to go into cursor mode, for quicker selection of expressions and subexpressions (see page 15-10).
Edit expr.	Enables you to edit the highlighted expression on the edit line, just as you do in the HOME screen (see page 15-11).
Change font	Enables you to choose to type using large or small characters (see page 15-10).
Cut	Copies the selection to the clipboard and erases the selection from Equation Writer.
Copy	Copies the selection to the clipboard.
Paste	Copies the contents of the clipboard to the location of the cursor. The clipboard contents will be either whatever Copy or Cut selected the last time you used these commands, or the highlighted level when you selected COPY in CAS history.

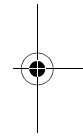
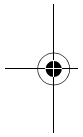

### ALGB menu

The **ALGB** menu contains functions that enable you to perform algebra, such as factoring, expansion, simplification, substitution, and so on.



### DIFF menu

The **DIFF** menu contains functions that enable you to perform differential calculus, such as differentiation, integration, series expansion, limits, and so on.

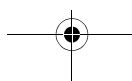
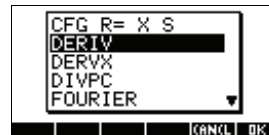

### REWRI menu

The **REWRI** menu contains functions that enable you to rewrite an expression in another form.



### SOLV menu

The **SOLV** menu contains functions that enable you to solve equations, linear systems, and differential equations.



### TRIG menu

The **TRIG** menu contains functions that enable you to transform trigonometric expressions.

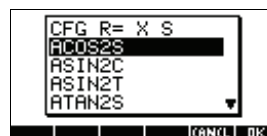

**NOTE** You can get online help about any CAS function by pressing **[SHIFT]** **2** and selecting that function (as explained in "Online Help" on page 14-8).

## Configuration menus

You can directly see, and change, CAS modes while working with the Equation Writer. The first line in each of the Equation Writer menus (except **TOOL**) indicates the current CAS mode settings.

In the example at the right, the first line of the **TRIG** menu reads:

CFG R= X S

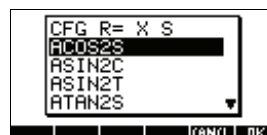

CFG stands for "configuration", and the symbols to the right of it indicate various mode settings.

- The first symbol, R, indicates that you are in real mode. If you were in complex mode, this symbol would be C.
- The second symbol, =, indicates that you are in exact mode. If you were in approximate mode, this symbol would be ~.
- The third symbol, X in the above example, indicates the current independent variable.



- The fourth symbol, S, in the above example, indicates that you are in step-by-step mode. If you were not in step-by-step mode, this symbol would be D (which stands for Direct).

The first line of an Equation Writer menu only indicates some of the mode settings. To see more settings, highlight the first line and press  $\text{F1}$ .



The configuration menu appears. The header of the configuration menu has additional symbols. In the example above, the upward-pointing arrow indicates that polynomials are displayed with increasing powers, and the 13 indicates the modulo value.

You can change CAS mode settings directly from the configuration menu. Just press  $\text{↓}$  until the setting you want to choose is highlighted and then press  $\text{F1}$ .

Note that the configuration menu includes only those options that are not currently selected. For example, if Rigorous is a current setting, its opposite, Sloppy, will appear on the menu. If you choose Sloppy, then Rigorous appears in its place.

To return your CAS modes to their default settings, select Default cfg and press  $\text{F1}$ .

To close the configuration menu, select Quit config and press  $\text{F1}$ .

#### NOTE

You can also change CAS mode settings from CAS MODES screen. See "CAS modes" on page 14-5 for information.

#### Online Help language

One CAS setting that only appears on the configuration menu is the setting that determines the language of the online help. Two languages are available:

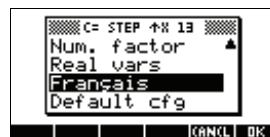

English and French. To choose French, select Francais and press  $\text{F1}$ . To return to English, select English and press  $\text{F1}$ .

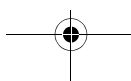





## Entering expressions and subexpressions

You type expressions in the Equation Writer is much the same way as you type them in the HOME screen, using the keys to directly enter numbers, letters and operators, and menus to select various functions and commands.

When you type an expression in the Equation Writer, the operator that you are typing always carries over to the adjacent or selected expression. You don't have to worry about where the parentheses go: they are automatically entered for you.

It will help you understand how the Equation Writer works if you view a mathematical expression as a tree, with the four arrow keys enabling you to move through the tree:

- the and keys enable you to move from one branch to another
- the and keys enable you to move up and down a particular tree
- the and key combinations enable you to make multiple selections.

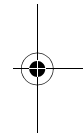
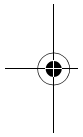

### How do I select?

There are two ways of going into selection mode:

- Pressing takes you into selection mode and selects the element adjacent to the cursor. For example:

$$1+2+3+4 \quad \uparrow$$

selects 4. Pressing it again selects the entire tree:  
1+2+3+4.

- Pressing takes you into selection mode and selects the branch adjacent to the cursor. Pressing it augments the selection, adding the next branch to the right. For example:

$$1+2+3+4 \quad \rightarrow$$

selects 3+4. Pressing it again selects 2+3+4, and again selects 1+2+3+4.

**NOTE:** If you are typing a templated function with multiple arguments (such as  $\Sigma$ ,  $\int$ , SUBST, etc.), pressing or enables you to move from one argument to another. In

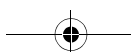



this case, you have to press  $\blacktriangle$  to select elements in the expression.

The following illustration shows how an expression can be viewed as a tree in the Equation Writer. It illustrates a tree view of the expression:

$$\frac{(5x + 3) \cdot (x - 1)}{x + 3}$$

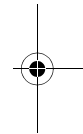
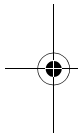
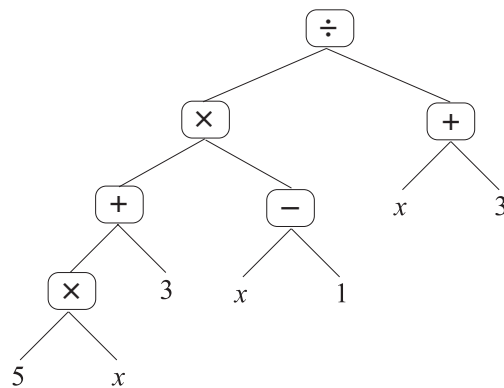

Suppose that the cursor is positioned to the right of 3:

- If you press  $\blacktriangle$  once, the 3 component is selected.
- If you press  $\blacktriangle$  again, the selection moves up the tree, with  $x + 3$  now selected.
- If you press  $\blacktriangle$  again, the selection moves up the tree, and now the entire expression is selected.
- If you had pressed  $\blacktriangleright$  instead of  $\blacktriangle$  when the cursor was positioned to the right of 3, the leaves of the branch get selected (that is,  $x + 3$ ).
- If you press  $\blacktriangleright$  again, the selection moves up the tree, and now the entire expression is selected.
- If you now press  $\blacktriangledown$ , just the numerator is selected.
- If you now press  $\blacktriangledown$  again, the top-most branch selected (that is,  $(5x + 3)$ ).
- Continue pressing  $\blacktriangledown$  to select each top-most leaf in turn (5x and then 5).





- Press  $\blacktriangle$  again and again to progressively select more of the top-most branch, and then lower branches (5x, 5x + 3, and then the entire numerator and finally the entire expression).

## More Examples

### Example 1

If you enter:

$$2 + X \times 3 - X$$

and press  $\blacktriangleright$   $\blacktriangleright$   $\blacktriangleright$  the entire expression is selected.



Pressing  $\text{ENTER}$  evaluates what is selected (that is, the entire expression) and returns:

$$2X + 2$$



If you enter the same expression as earlier but press  $\blacktriangleright$  after the first X, as in:

$$2 + X \blacktriangleright \times 3 - X$$

the 2 + X is selected and the next operation, multiplication, is applied to it. The expression becomes:

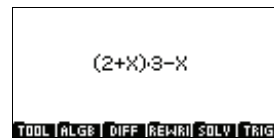

$$(2 + X) \times 3 - X$$

Pressing  $\blacktriangleright$   $\blacktriangleright$  selects the entire expression, and pressing  $\text{ENTER}$  evaluates it, resulting in:

$$2X + 6$$



Now enter the same expression, but press  $\blacktriangle$  after the 3, as in:

$$2 + X \blacktriangleright \times 3 \blacktriangle - X$$

Note that  $\blacktriangleright$  selects the expression so far entered (2 + X) thus making the next operation apply to the entire selection, not just the last entered term. The  $\blacktriangle$  key selects just the last entry (3) and makes the next operation

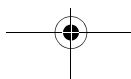
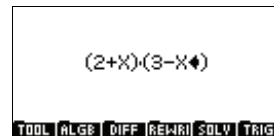



(- X) apply to it. As a result, the entered expression is interpreted, and displayed, as  $(2 + X)(3 - X)$ .

Select the entire expression by pressing  $\leftarrow$   $\leftarrow$   $\leftarrow$  and evaluate it by pressing  $\text{ENTER}$ . The result is:

$$-(X^2 - X - 6)$$



### Example 2

To enter  $X^2 - 3X + 1$ , press:

$\left[ \text{X,T,}\theta \right]$   $\left[ X^Y \right]$  2  $\leftarrow$  - 3  $\left[ \text{X,T,}\theta \right]$  + 1

If, instead, you had to enter  $-X^2 - 3X + 1$ , you would need to press:

$\left[ (-) \right]$   $\left[ \text{X,T,}\theta \right]$   $\left[ X^Y \right]$  2  $\leftarrow$  - 3  $\left[ \text{X,T,}\theta \right]$  + 1

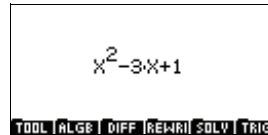

Note that you press  $\leftarrow$  twice to ensure that the exponent applies to  $-X$  and not just to  $X$ .

### Example 3

Suppose you want to enter:

$$\frac{1}{2} + \frac{1}{3} + \frac{1}{4} + \frac{1}{5}$$

Each fraction can be viewed as a separate branch on the equation tree. In the Equation Writer type the first branch:



$$1 \div 2$$

and then select this branch by pressing  $\leftarrow$ .

Now type + and enter the second branch:

$$1 \div 3$$

Select the second branch by pressing  $\leftarrow$ .

Now type + and enter the third branch:

$$1 \div 4$$

Likewise, select the third branch by pressing  $\leftarrow$ , type + and then the fourth branch:

$$1 \div 5$$

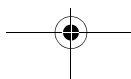



Select the fifth branch by pressing  $\blacktriangleright$ . At this point, the desired expression is in the Equation Writer, as shown at the right.

$$\frac{1}{2} + \frac{1}{3} + \frac{1}{4} + \frac{1}{5}$$

Suppose that you want to select the second and third branches, that is:  $\frac{1}{3} + \frac{1}{4}$ . First press  $\blacktriangleleft$   $\blacktriangleleft$ . This selects  $\frac{1}{3}$ , the second term.

Now press  $\text{SHIFT}$   $\blacktriangleright$ . This key combination enables you to select two contiguous branches, the one already selected and the one to the right of it.

$$\frac{1}{2} + \frac{1}{3} + \frac{1}{5}$$

If you want, you can evaluate the selected part by pressing  $\text{ENTER}$ . The result is shown at the right.

$$\frac{1}{2} + \frac{7}{12} + \frac{1}{5}$$

Suppose now you want to perform the partial calculation:

$$\frac{1}{2} + \frac{1}{5}$$

Because the two terms in this partial calculation are not contiguous (that is, side by side), you must first perform a permutation so that they are side by side. To do this, press:

$\text{SHIFT}$   $\blacktriangleleft$

This exchanges the selected element with its neighbour to the left. The result is shown at the right.

$$\frac{7}{12} + \frac{1}{2} + \frac{1}{5}$$

Now press:

$\blacktriangleright$   $\text{SHIFT}$   $\blacktriangleright$

to select just the branches you are interested in:

$$\frac{7}{12} + \frac{1}{2} + \frac{1}{5}$$

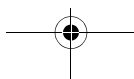
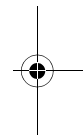
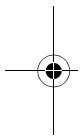



Pressing **ENTER** produces the result of the partial calculation.

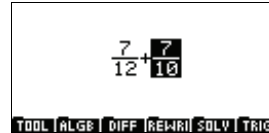

### Summing up

Pressing **SHIFT** **▶** enables you to select the current element and its neighbour to the right. **SHIFT** **◀** enables you to exchange the selected element with its neighbour to the left. The selected element remains selected after you move it.

## Cursor mode

In cursor mode you can select a large expression quickly. To select cursor mode, press:

**TOOL** Cursor mode

As you press the arrow key, various parts of the expression are enclosed in a box.



When what you want to select is enclosed, press **ENTER** to select it.

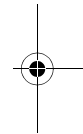
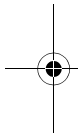

## Changing the font

If you are entering a long expression, you may find it useful to reduce the size of the font used in the Equation Writer. Select **Change font** from the **TOOL** menu. This enables you to view a large expression in its entirety when you need to. Selecting **Change font** again returns the font size to its previous setting.

You can also see the selected expression or subexpression in a smaller or larger font size by pressing **VIEWS** and then **TEXT** (to use the smaller font) or **GRAPH** (to use the larger font).

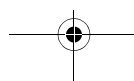



## How to modify an expression

If you're typing an expression, the **DEL** key enables you to erase what you've typed. If you're selecting, you can:

- Cancel the selection without deleting the expression by pressing **DEL**. The cursor moves to the end of the deselected portion.
- Replace the selection with an expression, just by typing the desired expression.
- Transform the selected expression by applying a CAS function to it (which you can invoke from one of CAS menus along the bottom of the screen).
- Delete the selected expression by pressing:

**ALPHA** **SHIFT** **DEL**

- Delete a selected unary operator at the top of the expression tree by pressing:

**SHIFT** **DEL**

For example, to replace  $\text{SIN}(\text{expr})$  with  $\text{COS}(\text{expr})$ , select  $\text{SIN}(\text{expr})$ , press **SHIFT** **DEL** and then press **COS**.

- Delete a binary infix operator and one of its arguments by selecting the argument you want delete and pressing:

**SHIFT** **DEL**

For example, if you have the expression  $1+2$  and select 1, pressing **SHIFT** **DEL** deletes 1+ and leaves only 2. Similarly, to delete  $F(x)=$  in the expression  $F(x) = x^2 - x + 1$ , you select  $F(x)$  and then press **SHIFT** **DEL**. This produces  $x = x^2 - x + 1$ .

- Delete a binary operator by selecting:

Edit expr.

from the **TUCL** menu and then making the correction.

- Copy an element from CAS history. You access CAS history by pressing **SYMB**. See page 15-19 for details.

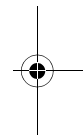
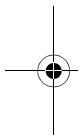

## Accessing CAS functions

While you are in the Equation Writer, you can access all CAS functions, and you can access them in various ways.

**General principle:** When you have written an expression in the Equation Writer, all you have to do is press **ENTER** to evaluate whatever you have selected (or the entire expression, if nothing is selected).

### How to type $\Sigma$ and $\int$

Press **SHIFT** **+** to enter  $\Sigma$  and **SHIFT** **d/dx** to enter  $\int$ .

These symbols are treated as prefix functions with multiple arguments. They are automatically placed before the selected element, if there is one (hence the term *prefix functions*).

You can move the cursor from argument to argument by pressing **▶** or **◀**.

Enter the expressions according to the rules of selection explained earlier, but you must first go into selection mode by pressing **▲**.

### NOTE

Do not use the index  $i$  to define a summation, because  $i$  designates the complex-number solution of  $x^2 + 1 = 0$ .

$\Sigma$  performs exact calculations if its argument has a discrete primitive; otherwise it performs approximate calculations, even in exact mode. For example, in both approximate and exact mode:

$$\sum_{k=0}^4 \frac{1}{k!} = 2.70833333334$$

whereas in exact mode:

$$1 + \frac{1}{1!} + \frac{1}{2!} + \frac{1}{3!} + \frac{1}{4!} = \frac{65}{24}$$

Note that  $\Sigma$  can symbolically calculate summations of rational fractions and hypergeometric series that allow a discrete primitive. For example, if you type:

$$\sum_{K=1}^4 \frac{1}{K \cdot (K+1)}$$





select the entire expression and press **ENTER**, you obtain:

$$\frac{4}{5}$$

However, if you type:

$$\sum_{K=1}^{\infty} \frac{1}{K \cdot (K+1)}$$

select the entire expression and press **ENTER**, you obtain 1.

### How to enter infix functions

An infix function is one that is typed *between* its arguments. For example, **AND**, **|** and **MOD** are infix functions. You can either:

- type them in Alpha mode and then enter their arguments, or
- select them from a CAS menu or by pressing an appropriate key, provided that you have already written and selected the first argument.

You move from one argument to the other by pressing **▶** and **◀**. The comma enables you to write a complex number: when you type (1,2), the parentheses are automatically placed when you type the comma. If you want to type (-1,2), you must select -1 before you type the comma.

### How to enter prefix functions

A prefix function is one that is typed *before* its arguments. To enter a prefix function, you can:

- type the first argument, select it, then select the function from a menu, or
- you can select the function from a menu, or by directly entering it in Alpha mode, and then type the arguments.

The following example illustrates the various ways of entering a prefix function. Suppose you want to factor the expression  $x^2 - 4$ , then find its value for  $x = 4$ . **FACTOR** is the function for factoring, and it is found on the **ALG3** menu. **SUBST** is the function for substituting a value for a variable in an expression, and it is also found in the **ALG3** menu.

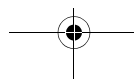
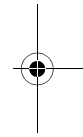
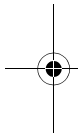

**First option: function first, then arguments**

In the Equation Writer, press **ALG**, select FACTOR and then press **ENTER** or **RTN**. FACTOR ( ) is displayed in the Equation Writer, with the cursor between the parentheses (as shown at the right).



Enter your expression, using the rules of selection described earlier.

**X,T,θ** **X<sup>Y</sup>** 2 **▶** - 4 **▶**  
**▶**

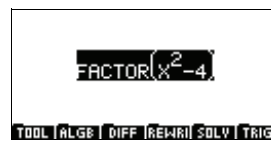

The entire expression is now selected.

Press **ENTER** then produce the result.

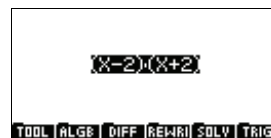

With a blank Equation Writer screen, press **ALG**, select SUBST and then press **ENTER** or **RTN**.

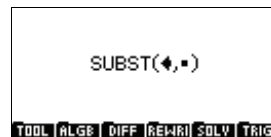

With the cursor between the parentheses at the location of the first argument, type your expression.

Note that SUBST has two arguments. When you have finished entering the first argument (the expression), press **▶** to move to the second argument.

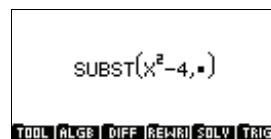

Now enter the second argument, x=4.

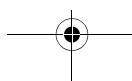
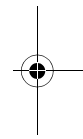
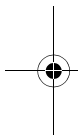
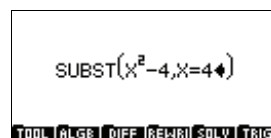

Press **ENTER** to obtain the an intermediate result  $(4^2 - 4)$  and **ENTER** again to evaluate the intermediate result. The final answer is 12.



### Second option: arguments first, then function

Enter your expression, using the rules of selection described earlier.



**X,T,θ** **X<sup>Y</sup>** 2 **▶** **-** 4 **▶**  
**▶** **▶**

The entire expression is now selected.

Now press **ALGB** and select **FACTOR**. Notice that the **FACTOR** is applied to whatever was selected (which is automatically placed in parentheses).

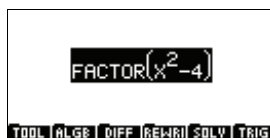

Press **ENTER** to evaluate the expression. The result is the factors of the expression.

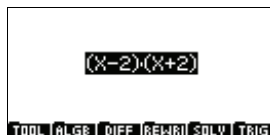

Because the result of an evaluation is always selected, you can immediately apply another command to it.

To illustrate this, press **ALGB**, select **SUBST** and then press **ENTER** or **↵**. Note that **SUBST** is applied to whatever was selected (which is automatically placed in parentheses). Note too that the cursor is automatically placed in the position of the second argument.

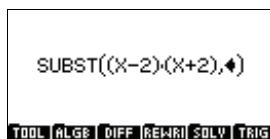

Enter the second argument,  $x=4$ .

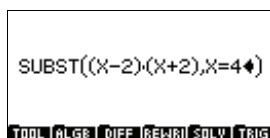



Press **ENTER** to obtain an intermediate result,  $(4 - 2)(4 + 2)$ , and **ENTER** again to evaluate the intermediate result. The final answer, as before, is 12.



**Note** If you call a CAS function while you're writing an expression, whatever is currently selected is copied to the function's first or main argument. If nothing is selected, the cursor is placed at the appropriate location for completing the arguments.

## Equation Writer variables

You can store objects in variables, then access an object by using the name of its variable. However, you should note the following:

- Variables used in CAS cannot be used in HOME, and vice versa.
- In HOME or in the program editor, use **STORE** to store an object in a variable.
- In CAS, use the STORE command (on the **ALG** menu) to store a value in a variable.
- The **VAR** key displays a menu that contains all the available variables. Pressing **VAR** while you are in HOME displays the names of the variables defined in HOME and in the Aplets. Pressing **VAR** while you are in the Equation Writer displays the names of the variables defined in CAS (as explained on page 15-18).

## Predefined CAS variables

- **VX** contains the name of the current symbolic variable. Generally, this is  $X$ , so you should not use  $X$  as the name of a numeric variable. Nor should you erase the contents of  $X$  with the **UNASSIGN** command (on the **ALG** menu) after having done a symbolic calculation.
- **EPS** contains the value of epsilon used in the **EPSX0** command.

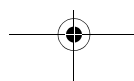



- **MODULO** contains the value of  $p$  for performing symbolic calculations in  $Z/pZ$  or in  $Z/pZ[X]$ . You can change the value of  $p$  either with the **MODSTO** command on the **MODULAR** menu, (by typing, for example, **MODSTO(n)** to give  $p$  a value of  $n$ ), or from **CAS MODES** screen (see page 14-5).
- **PERIOD** must contain the period of a function before you can find its Fourier coefficients.
- **PRIMIT** contains the primitive of the last integrated function.
- **REALASSUME** contains a list of the names of the symbolic variables that are considered reals. If you've chosen the **Cmplx vars** option on the **CFG** configuration menu, the defaults are  $X, Y, t, S1$  and  $S2$ , as well as any integration variables that are in use.

If you've chosen the **Real vars** option on the **CFG** configuration menu, all symbolic variables are considered reals. You can also use an assumption to define a variable such as  $X > 1$ . In a case like this, you use the **ASSUME(X>1)** command to make **REALASSUME** contain  $X > 1$ . The command **UNASSUME(X)** cancels all the assumptions you have previously made about  $X$ .

To see these variables, as well as those that you've defined in **CAS**, press **[VARS]** in the Equation Editor (see "CAS variables" on page 14-4).

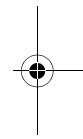
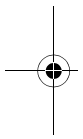

## The keyboard in the Equation Writer

The keys mentioned in this section have different functions when pressed in the Equation Writer than when used elsewhere.

### MATH key

The **[MATH]** key, if pressed in the Equation Writer, displays just those functions used in symbolic calculation. These functions are contained in the following menus:



- The five function-containing Equation Writer menus outlined in the previous section: **Algebra** (**[ALGB]**),

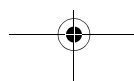

Diff&Int (**DIFF**), Rewrite (**REWR**), Solve (**SOLV**) and Trig (**TRIG**).

- The **Complex** menu, providing functions specific to manipulating with complex numbers.
- The **Constant** menu, containing  $e$ ,  $i$ ,  $\infty$  and  $\pi$ .
- The **Hyperb.** menu, containing hyperbolic functions.
- The **Integer** menu, containing functions that enable you to perform integer arithmetic.
- The **Modular** menu, containing functions that enable you to perform modular arithmetic (using the value contained in the **MODULO** variable).
- The **Polynom.** menu, containing functions that enable you to perform calculations with polynomials.
- The **Real** menu, containing functions specific to common real-number calculations
- The **Tests** menu, containing logic functions for working with hypotheses.

### SHIFT MATH keys

The **SHIFT** **MATH** key combination opens an alphabetical menu of all CAS commands. You can enter a command by selecting it from this menu, so that you don't have to type it in ALPHA mode.



### VARS key

Pressing **VARS** while you're in the Equation Writer displays the names of the variables defined in CAS. Take special note of **namVX**, which contains the name of the current variable.



The menu options on the variables screen are:

- ECHO** Press to copy the name of the highlighted variable to the position of the cursor in Equation Writer.
- VIEW** Press to see the contents of the highlighted variable.
- EDIT** Press to change the contents of the highlighted variable.

- PURE** Press to clear the value of the highlighted variable.
- RENA** Press to change the name of the highlighted variable.
- NEW** Press to define a new variable (which you do by specifying an object and a name for the object).

### SYMB key

Pressing the **SYMB** key in the Equation Writer gives you access to CAS history. As in the HOME screen history, the calculations are written on the left and the results are written on the right. Using the arrow keys, you can scroll through the history.

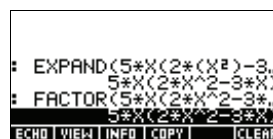

Press **COPY** to copy the highlighted entry in history to the clipboard in order to paste it in the Equation Writer. Press **ENTER** or **EDIT** to replace the current selection in Equation Writer with the highlighted entry in CAS history. Press **ON** to leave CAS history without changing it in any way.

### SHIFT SYMB or SHIFT HOME keys

While you are working in the Equation Writer, pressing **SHIFT SYMB** or **SHIFT HOME** opens CAS MODES screen. The various CAS modes are described in "CAS modes" on page 14-5.



### SHIFT , key

Pressing **SHIFT ,** followed by the comma key undoes (that is, cancels) your last operation.

### PLOT key

Pressing **PLOT** in the Equation Writer displays a menu of plot types. You can choose to graph a function, a parametric curve, or a polar curve.



Depending on what you choose, the highlighted expression is copied into the appropriate aplet, to the destination that you specify.

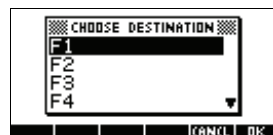

**NOTE**

---

This operation supposes that the current variable is also the variable of the function or curve you want to graph. When the expression is copied, it is evaluated, and the current variable (contained in VX) is changed to X, T, or  $\theta$ , depending on the type of plot you chose.

---

If the function depends on a parameter, it is preferable to give the parameter a value before pressing **PLOT**. If, however, you want the parameterized expression to be copied with its parameter, then the name of the parameter must consist of a single letter other than X, T, or  $\theta$ , so that there is no confusion. If the highlighted expression has real values, the Function, Aplet or Polar Aplet can be chosen, and the graph will be of Function or Polar type. If the highlighted expression has complex values, the Parametric Aplet must be chosen, and the graph will be of Parametric type.

To summarize. If you choose:

- the Function Aplet, the highlighted expression is copied into the chosen function  $F_i$ , and the current variable is changed to X.
- the Parametric Aplet, the real part and the imaginary part of the highlighted expression are copied into the chosen functions  $X_i, Y_i$ , and the current variable is changed to T.
- the Polar Aplet, the highlighted expression is copied into the chosen function  $R_i$  and the current variable is changed to  $\theta$ .

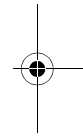
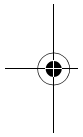
**NUM key**

Pressing **NUM** in the Equation Writer causes the highlighted expression to be replaced by a numeric approximation. **NUM** puts the calculator into approximate mode.

**SHIFT NUM key**

Pressing **SHIFT NUM** in the Equation Writer causes the highlighted expression to be replaced by a rational number. **SHIFT NUM** puts the calculator into exact mode.

**VIEWS key**

Pressing **VIEWS** in the Equation Writer enables you to move the cursor with the **▶** and **◀** arrow keys to see the entire highlighted expression. Press **↩** to return in the Equation Writer.

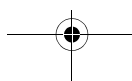





### Short-cut keys

In the Equation Writer, the following are short-cut keys to the symbols indicated:

**SHIFT** 0 for  $\infty$

**SHIFT** 1 for  $i$

**SHIFT** 3 for  $\pi$

**SHIFT** 5 for  $<$

**SHIFT** 6 for  $>$

**SHIFT** 8 for  $\leq$

**SHIFT** 9 for  $\geq$

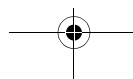
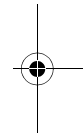
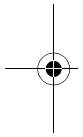

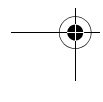
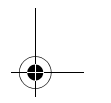
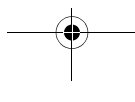
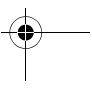
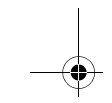
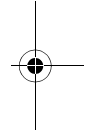
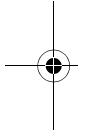
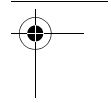
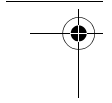
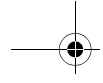



## Step-by-Step Examples

---

### Introduction

This chapter illustrates the power of CAS, and the Equation Writer, by working through a number of examples. Some of these examples are variations on questions from senior math examination papers.

The examples are given in order of increasing difficulty.

### Example 1

If A is: 
$$\frac{\frac{3}{2} - 1}{\frac{1}{2} + 1}$$

calculate the result of A in the form of an irreducible fraction, showing each step of the calculation.

**Solution:** In the Equation Writer, enter A by typing:

3  $\div$  2  $\blacktriangleright$  - 1  $\blacktriangleright$   
 $\blacktriangleright$   $\div$  1  $\div$  2  $\blacktriangleright$   
 + 1

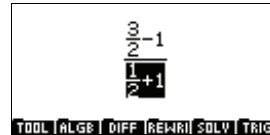

Now press  $\blacktriangleright$  to select the denominator (as shown above).

Press  $\text{ENTER}$  to simplify the denominator.

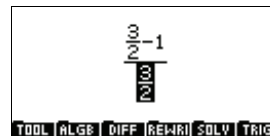

Now select the numerator by pressing  $\blacktriangleleft$ .

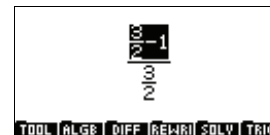



Press **ENTER** to simplify the numerator.



Press **▲** to select the entire fraction.

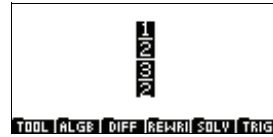

Press **ENTER** to simplify the selected fraction, giving the result shown at the right.



## Example 2

Given that  $C = 2\sqrt{45} + 3\sqrt{12} - \sqrt{20} - 6\sqrt{3}$

write  $C$  in the form  $d\sqrt{3}$ , where  $d$  is a whole number.

**Solution:** In the Equation Writer, enter  $C$  by typing:

2 **SHIFT** **X<sup>2</sup>** 45 **▶**  
**▶** **+** 3 **SHIFT** **X<sup>2</sup>**  
 12 **▶** **▶** **-** **SHIFT**  
**X<sup>2</sup>** 20 **▶** **▶** **-** 6  
**SHIFT** **X<sup>2</sup>** 3

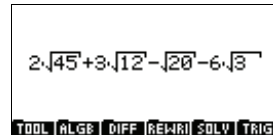

Press **▶** **▶** **▶** to select  $-6\sqrt{3}$ .

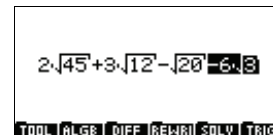

Press **◀** to select  $-\sqrt{20}$  and **▼** **▼** to select 20.

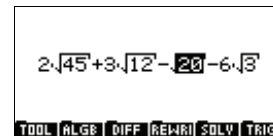

Now press **ALGB**, select FACTOR and press **EXE**.

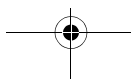
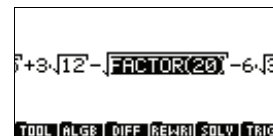



Press **ENTER** to factor  
20 into  $2^2 \cdot 5$ .

2√45+3√12-**20**-6√3

TOOL | ALG | DIFF | REWR | SOLV | TRIG

Press **▲** to select  
 $\sqrt{2^2 \cdot 5}$  and **ENTER** to  
simplify it.

2√45+3√12-**2√5**-6√3

TOOL | ALG | DIFF | REWR | SOLV | TRIG

Press **▶** to select  
 $-2\sqrt{5}$  and **SHIFT** **◀**  
to exchange  $3\sqrt{12}$  with  
 $-2\sqrt{5}$ .

2√45-**2√5**+3√12-6√3

TOOL | ALG | DIFF | REWR | SOLV | TRIG

Press **◀** to select  
 $2\sqrt{45}$  and **▼** **▶** **▼**  
to select 45.

2√**45**-2√5+3√12-6√3

TOOL | ALG | DIFF | REWR | SOLV | TRIG

Press **ALG**, select  
FACTOR and press  
**□**.

2√**FACTOR(45)**-2√5+3√12-6√3

TOOL | ALG | DIFF | REWR | SOLV | TRIG

Press **ENTER** to factor  
45 into  $3^2 \cdot 5$ .

2√**3<sup>2</sup>·5**-2√5+3√12-6√3

TOOL | ALG | DIFF | REWR | SOLV | TRIG

Press **▲** to select  
 $\sqrt{3^2 \cdot 5}$  and **ENTER** to  
simplify the selection.

2√**3·5**-2√5+3√12-6√3

TOOL | ALG | DIFF | REWR | SOLV | TRIG

Press **▲** to select  
 $2 \cdot 3\sqrt{5}$ , and **SHIFT**  
**▶** to select  
 $2 \cdot 3\sqrt{5} - 2\sqrt{5}$ .

**2·3√5**-2√5+3√12-6√3

TOOL | ALG | DIFF | REWR | SOLV | TRIG

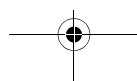



Press **ENTER** to evaluate the selection.

4. $\sqrt{5}$ +3. $\sqrt{12}$ -6. $\sqrt{3}$

TOOL | ALGB | DIFF | REWR | SOLV | TRIG

It remains to transform  $3\sqrt{12}$  and combine it with  $-6\sqrt{3}$ . Follow the same procedure as undertaken a number of times above. You will find that  $3\sqrt{12}$  is equal to  $6\sqrt{3}$ , and so the final two terms cancel each other out.

4. $\sqrt{5}$ +6. $\sqrt{3}$ -6. $\sqrt{3}$

TOOL | ALGB | DIFF | REWR | SOLV | TRIG

Hence the result is  $C = 4\sqrt{5}$

4. $\sqrt{5}$

TOOL | ALGB | DIFF | REWR | SOLV | TRIG

### Example 3

Given the expression  $D = (3x - 1)^2 - 81$ :

- expand and reduce  $D$
- factor  $D$
- solve the equation  $(3x - 10) \cdot (3x + 8) = 0$  and
- evaluate  $D$  for  $x = 5$ .

**Solution:** First, enter  $D$  using the Equation Writer:

3 **ALPHA** X **-** 1 **▶**  
**▶** **X<sup>Y</sup>** 2 **▶** **-** 81

(3X-1)<sup>2</sup>-81

TOOL | ALGB | DIFF | REWR | SOLV | TRIG

Press **▶** **◀** to select  $(3X - 1)^2$  and **ENTER** to expand the expression. This gives:  $9x^2 - 6x + 1 - 81$

9X<sup>2</sup>-6X+1-81

TOOL | ALGB | DIFF | REWR | SOLV | TRIG

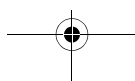

Press  $\blacktriangle$  to select the entire equation, then press  $\text{ENTER}$  to reduce it to  $9x^2 - 6x - 80$ .

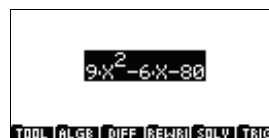

Press  $\text{ALG}$ , select FACTOR, press  $\text{F2}$  and then  $\text{ENTER}$ . The result is as shown at the right.

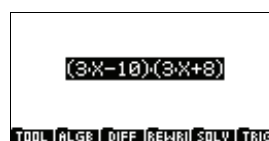

Now press  $\text{SOLV}$ , select SOLVEVX, press  $\text{F2}$  and press  $\text{ENTER}$ . The result is shown at the right.

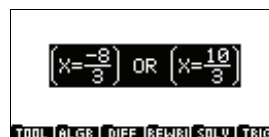

Press  $\text{SYMB}$  to display CAS history, select D or a version of it, and press  $\text{ENTER}$ .

Press  $\text{ALG}$ , select SUBST, press  $\text{F2}$  and, then complete the second argument:  $x = -5$

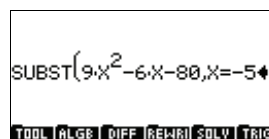

Press  $\blacktriangleright \blacktriangleright \blacktriangleright$  to select the entire expression and then  $\text{ENTER}$  to obtain the intermediate result shown.

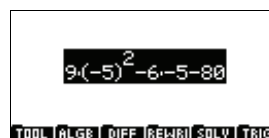

Press  $\text{ENTER}$  once more to yield the result: 175. Therefore,  $D = 175$  when  $x = -5$ .



### Example 4

A baker produces two assortments of biscuits and macaroons. A packet of the first assortment contains 17 biscuits and 20 macaroons. A packet of the second assortment contains 10 biscuits and 25 macaroons. Both packets cost 90 cents.

Calculate the price of one biscuit, and the price of one macaroon.

**Solution:** Let  $x$  be the price of one biscuit, and  $y$  the price of one macaroon. The problem is to solve:

$$17x + 20y = 90$$

$$10x + 25y = 90$$

Press **SOLV**, select LINSOLVE and press **ENTER**.

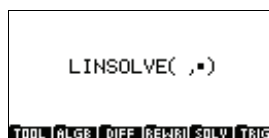

Enter 17 **ALPHA** X **+** 20 **ALPHA** Y **-** 90 **ENTER** **RIGHT** **RIGHT** **SHIFT** **(-)** 10 **ALPHA** X **+** 25 **ALPHA** Y **-** 90 **ENTER** **ALPHA** X **SHIFT** **(-)** **ALPHA** Y

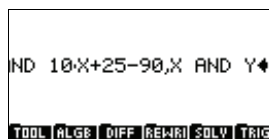

If you are working in step by step mode, pressing **ENTER** produces the result at the right.

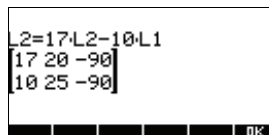

Press **ENTER** again to produce the next step in the solution:

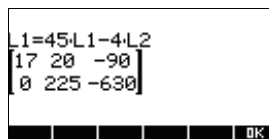

Press **ENTER** again to produce the reduction result:

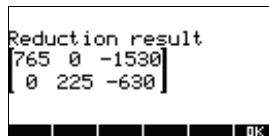

Pressing **ENTER** again produces the final result:

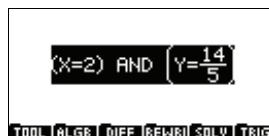

If you select  $\frac{14}{5}$ , and press **NUM** you get X = 2 and Y = 2.8. In other words, the price of one biscuit is 2 cents, and the price of one macaroon is 2.8 cents.

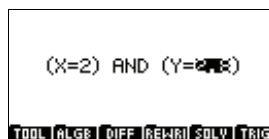

### Exercise 5

Suppose that A and B are points having the coordinates (-1, 3) and (-3,-1) respectively, and where the unit of measure is the centimetre.



1. Find the exact length of  $AB$  in centimetres.
2. Determine the equation of the line  $AB$ .

### First method

Type:

STORE ( (-1, 3) , A)

and press **ENTER**.

Accept the change to Complex mode, if necessary.

Note that pressing **ENTER** returns the coordinates in complex form:  $-1+3i$ .

Now type:

STORE ( (-3, -1) , B)

and press **ENTER**.

The coordinates this time are represented as  $-3-1\cdot i$ .

The vector  $AB$  has coordinates  $B - A$ .

Type:

**SHIFT** **[ ]** ( B - A)

Press **ENTER**. The result is  $2\sqrt{5}$ .

Now apply the DROITE command to determine the equation of the line  $AB$ :

**MATH** Complex

DROITE **[ALPHA]** A **[▶]**

**[ALPHA]** B

Pressing **ENTER** gives an intermediate result.

STORE((-1,3),A)

TOOL ALGE DIFF [REWR] SOLV TRIG

-1+3i

TOOL ALGE DIFF [REWR] SOLV TRIG

[B-A]

TOOL ALGE DIFF [REWR] SOLV TRIG

2\*sqrt(5)

TOOL ALGE DIFF [REWR] SOLV TRIG

DROITE(A,B)

TOOL ALGE DIFF [REWR] SOLV TRIG

Y=2(X--1)+3

TOOL ALGE DIFF [REWR] SOLV TRIG



Press **ENTER** again to simplify the result to  $Y = 2X+5$ .



### Second method

Type:

$$(-3, -1) - (-1, 3) \text{ ENTER}$$

The answer is  $-(2+4i)$ .

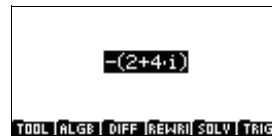

With the answer still selected, apply the **ABS** command by pressing **SHIFT** **( )**.

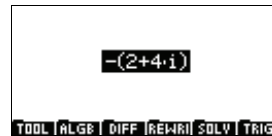

Pressing **ENTER** gives  $2\sqrt{5}$ , the same answer as with method 1 above.

You can also determine the equation of the line  $AB$  by typing:

$$\text{DROITE}(( -1, 3), (-3, -1)) \text{ ENTER}$$

Pressing **ENTER** then gives the result obtained before:  $Y = -(2X+5)$ .

### Exercise 6

In this exercise, we consider some examples of integer arithmetic.

#### Part 1

For  $n$ , a strictly positive integer, we define:

$$a_n = 4 \times 10^n - 1, b_n = 2 \times 10^n - 1, c_n = 2 \times 10^n + 1$$

1. Compute  $a_1, b_1, c_1, a_2, b_2, c_2, a_3, b_3$  and  $c_3$ .
2. Determine how many digits the decimal representations of  $a_n$  and  $c_n$  can have. Show that  $a_n$  and  $c_n$  are divisible by 3.
3. Using a list of prime numbers less than 100, show that  $b_3$  is a prime.

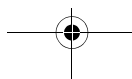

4. Show that for every integer  $n > 0$ ,  $b_n \times c_n = a_{2n}$ .
5. Deduce the prime factor decomposition of  $a_6$ .
6. Show that  $\text{GCD}(b_n, c_n) = \text{GCD}(c_n, 2)$ . Deduce that  $b_n$  and  $c_n$  are prime together.

**Solution:** Begin by entering the three definitions. Type:

$$\text{DEF}(A(N) = 4 \cdot 10^{N-1})$$

$$\text{DEF}(B(N) = 2 \cdot 10^{N-1})$$

$$\text{DEF}(C(N) = 2 \cdot 10^{N+1})$$

Here are the keystrokes for entering the first definition:

First select the **DEF** command by pressing **ALG**  $\downarrow$  **DEF**.

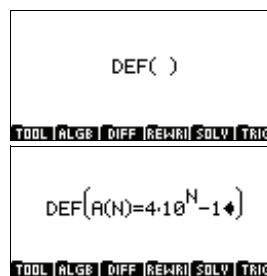

Now press **ALPHA** **A** **(** **ALPHA** **N** **)** **SHIFT** **=** **4** **(** **X** **10** **X** **Y** **ALPHA** **N** **)** **-** **1**

Finally press **ENTER**.

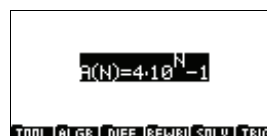

Do likewise to define the other two expressions.

You can now calculate various values of  $A(N)$ ,  $B(N)$  and  $C(N)$  simply by typing the defined variable and a value for  $N$ , and then pressing **ENTER**. For example:

- $A(1)$  **ENTER** yields 39
- $A(2)$  **ENTER** yields 399
- $A(3)$  **ENTER** yields 3999
- $B(1)$  **ENTER** yields 19
- $B(2)$  **ENTER** yields 199
- $B(3)$  **ENTER** yields 1999

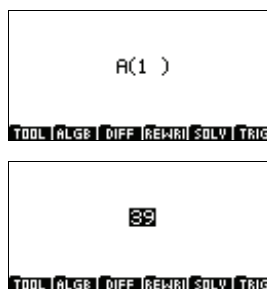

and so on.

In determining the number of digits the decimal representations of  $a_n$  and  $c_n$  can have, the calculator is used only to try out different values of  $n$ .



Show that the whole numbers  $k$  such that:

$10^n \leq k < 10^{n+1}$  have  $(n+1)$  digits in decimal notation.

We have:

$$10^n < 3 \cdot 10^n < a_n < 4 \cdot 10^n < 10^{n+1}$$

$$10^n < b_n < 2 \cdot 10^n < 10^{n+1}$$

$$10^n < 2 \cdot 10^n < c_n < 3 \cdot 10^n < 10^{n+1}$$

so  $a_n, b_n, c_n$  have  $(n+1)$  digits in decimal notation.

Moreover,  $d_n = 10^n - 1$  is divisible by 9, since its decimal notation can only end in 9.

We also have:

$$a_n = 3 \cdot 10^n + d_n$$

and

$$c_n = 3 \cdot 10^n - d_n$$

so  $a_n$  and  $c_n$  are both divisible by 3.

Let's consider whether  $B(3)$  is a prime number.

Type `ISPRIME?(B(3))` and press `ENTER`. The result is 1, which means true. In other words,  $B(3)$  is a prime.

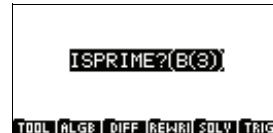

Note: `ISPRIME?` is not available from a CAS soft menu, but you can select it from from `CAS FUNCTIONS` menu while you are in the Equation Writer by pressing `MATH`, choosing the `INTEGER` menu, and scrolling to the `ISPRIME?` function.

To prove that  $b_3 = 1999$  is a prime number, it is necessary to show that 1999 is not divisible by any of the prime numbers less than or equal to  $\sqrt{1999}$ . As  $1999 < 2025 = 45^2$ , that means testing the divisibility of 1999 by  $n = 2, 3, 5, 7, 11, 13, 17, 19, 23, 29, 31, 37, 41$ . 1999 is not divisible by any of these numbers, so we can conclude that 1999 is prime.

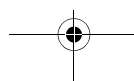
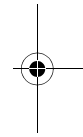
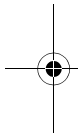

Now consider the product of two of the definitions entered above:  $B(N) \times C(N)$ :

$\boxed{\text{ALPHA}} \boxed{B} \boxed{\text{C}} \boxed{\text{ALPHA}} \boxed{N}$   
 $\boxed{\text{ALPHA}} \boxed{C} \boxed{\text{C}} \boxed{\text{ALPHA}} \boxed{N} \boxed{\text{ENTER}}$

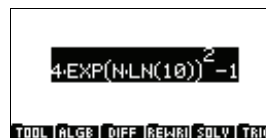

Press  $\boxed{\text{MATH}}$ ,  $\boxed{\downarrow}$ ,  $\boxed{\downarrow}$ ,  $\boxed{\downarrow}$  to select EXP2POW and press  $\boxed{\text{MATH}}$ .

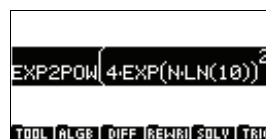

Press  $\boxed{\text{ENTER}}$  to evaluate the expression, yielding the result of  $B(N) \times C(N)$ .

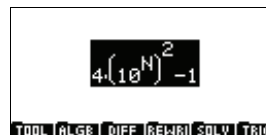

Consider now the decomposition of  $A(6)$  into its prime factors.

Press  $\boxed{\text{MATH}}$ ,  $\boxed{\downarrow}$ ,  $\boxed{\downarrow}$ ,  $\boxed{\downarrow}$  to select FACTOR and press  $\boxed{\text{MATH}}$ .

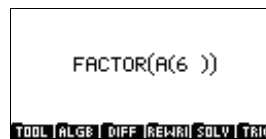

Now press  $\boxed{\text{ALPHA}} \boxed{A} \boxed{\text{C}} \boxed{6}$ .

Finally, press  $\boxed{\text{ENTER}}$  to get the result. The factors are listed, separated by a medial period. In this case, the factors are 3, 23, 29 and 1999.

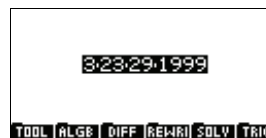

Now let's consider whether  $b_n$  and  $c_n$  are relatively prime. Here, the calculator is useful only for trying out different values of  $n$ .

To show that  $b_n$  and  $c_n$  are relatively prime, it is enough to note that:

$$c_n = b_n + 2$$

That means that the common divisors of  $b_n$  and  $c_n$  are the common divisors of  $b_n$  and 2, as well as the common divisors of  $c_n$  and 2.  $b_n$  and 2 are relatively prime because  $b_n$  is a prime number other than 2. So:



$$GCD(c_n, b_n) = GCD(c_n, 2) = GCD(b_n, 2) = 1$$

**Part 2**

Given the equation:

$$b_3 \cdot x + c_3 \cdot y = 1 \quad [1]$$

where the integers  $x$  and  $y$  are unknown and  $b_3$  and  $c_3$  are defined as in part 1 above:

1. Show that [1] has at least one solution.
2. Apply Euclid's algorithm to  $b_3$  and  $c_3$  and find a solution to [1].
3. Find all solutions of [1].

**Solution:** Equation [1] must have at least one solution, as it is actually a form of Bézout's Identity.

In effect, Bézout's Theorem states that if  $a$  and  $b$  are relatively prime, there exists an  $x$  and  $y$  such that:

$$a \cdot x + b \cdot y = 1$$

Therefore, the equation  $b_3 \cdot x + c_3 \cdot y = 1$  has at least one solution.

Now enter IEGCD(B(3), C(3)).

Note that the IEGCD function can be found on the INTEGER submenu of the MATH menu.

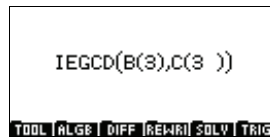

Pressing **ENTER** a number of times returns the result shown at the right:

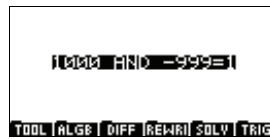

In other words:

$$b_3 \times 1000 + c_3 \times (-999) = 1$$

Therefore, we have a particular solution:

$$x = 1000, y = -999.$$

The rest can be done on paper:

$$c_3 = b_3 + 2, b_3 = 999 \times 2 + 1$$

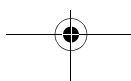



so,  $b_3 = 999 \times (c_3 - b_3) + 1$ , or

$$b_3 \times 1000 + c_3 \times (-999) = 1$$

The calculator is not needed for finding the general solution to equation [1].

We started with  $b_3 \cdot x + c_3 \cdot y = 1$

and have established that  $b_3 \times 1000 + c_3 \times (-999) = 1$ .

So, by subtraction we have:

$$b_3 \cdot (x - 1000) + c_3 \cdot (y + 999) = 0$$

$$\text{or } b_3 \cdot (x - 1000) = -c_3 \cdot (y + 999)$$

According to Gauss's Theorem,  $c_3$  is prime with  $b_3$ , so  $c_3$  is a divisor of  $(x - 1000)$ .

Hence there exists  $k \in Z$  such that:

$$(x - 1000) = k \times c_3$$

and

$$-(y + 999) = k \times b_3$$

Solving for  $x$  and  $y$ , we get:

$$x = 1000 + k \times c_3$$

and

$$y = -999 - k \times b_3$$

for  $k \in Z$ .

This gives us:

$$b_3 \cdot x + c_3 \cdot y = b_3 \times 1000 + c_3 \times (-999) = 1$$

The general solution for all  $k \in Z$  is therefore:

$$x = 1000 + k \times c_3$$

$$y = -999 - k \times b_3$$

## Exercise 7

Let  $m$  be a point on the circle  $C$  of center  $O$  and radius 1. Consider the image  $M$  of  $m$  defined on their affixes by the transformation  $F : z \rightarrow \frac{1}{2} \cdot z^2 - Z$ . When  $m$  moves on

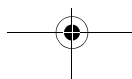

the circle  $C$ ,  $M$  will move on a curve  $\Gamma$ . In this exercise we will study and plot  $\Gamma$ .

1. Let  $t \notin [-\pi, \pi]$  and  $m$  be the point on  $C$  of affix  $z = e^{i \cdot t}$ . Find the coordinates of  $M$  in terms of  $t$ .
2. Compare  $x(-t)$  with  $x(t)$  and  $y(-t)$  with  $y(t)$ .
3. Compute  $x'(t)$  and find the variations of  $x$  over  $[0, \pi]$ .
4. Repeat step 3 for  $y$ .
5. Show the variations of  $x$  and  $y$  in the same table.
6. Put the points of  $\Gamma$  corresponding to  $t = 0, \pi/3, 2\pi/3$  and  $\pi$ , and draw the tangent to  $\Gamma$  at these points.

### Part 1

First go to CAS MODES screen and make  $t$  the VX variable. To do this, press  $\text{MODE}$  to open the Equation Writer, and then press  $\text{SHIFT}$   $\text{HOME}$ . This opens CAS MODES screen. Press  $\text{EDIT}$  and delete the current variable. Type  $\text{SHIFT}$   $\text{ALPHA}$  T and press  $\text{OK}$ .

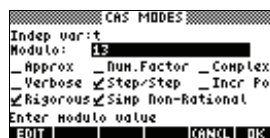

Now enter the expression  $\frac{1}{2} \cdot z^2 - z$  and press  $\text{▶}$   $\text{▶}$  to select it.

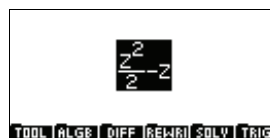

Now invoke the SUBST command from the  $\text{ALGB}$  menu. Because the expression was highlighted, the SUBST command is automatically applied to it.

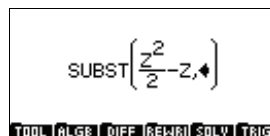

Note that the cursor is positioned in the second parameter. Since we know that  $z = e^{i \cdot t}$ , we can enter this as the second parameter.

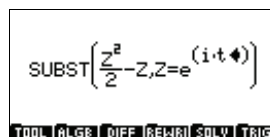



Selecting the entire expression and pressing **ENTER** gives the result at the right:

$$\frac{e^{(i \cdot t)^2}}{2} - e^{i \cdot t}$$

TOOL | ALGE | DIFF | REWR | SOLV | TRIG

Now linearize the result by applying the **LIN** command (which can be found on the **REWR** menu).

$$\text{LIN} \left( \frac{e^{(i \cdot t)^2}}{2} - e^{i \cdot t} \right)$$

TOOL | ALGE | DIFF | REWR | SOLV | TRIG

The result, after accepting the switch to complex mode, is shown at the right:

$$-1 \cdot \text{EXP}(i \cdot t) + \frac{1}{2} \cdot \text{EXP}(2 \cdot i \cdot t)$$

TOOL | ALGE | DIFF | REWR | SOLV | TRIG

Now store the result in variable M. Note that **STORE** is on the **ALGE** menu.

$$\text{STORE} \left( -1 \cdot \text{EXP}(i \cdot t) + \frac{1}{2} \cdot \text{EXP}(2 \cdot i \cdot t), M \right)$$

TOOL | ALGE | DIFF | REWR | SOLV | TRIG

To calculate the real part of the expression, apply the **RE** command (available on the **COMPLEX** submenu of the **MATH** menu).

$$\text{RE} \left( -1 \cdot \text{EXP}(i \cdot t) + \frac{1}{2} \cdot \text{EXP}(2 \cdot i \cdot t) \right)$$

TOOL | ALGE | DIFF | REWR | SOLV | TRIG

Pressing **ENTER** yields the result at the right:

$$\frac{\cos(t \cdot 2) - 2 \cdot \cos(t)}{2}$$

TOOL | ALGE | DIFF | REWR | SOLV | TRIG

We are now going to define this result as  $x(t)$ .

To do this, enter  $=X(t)$ , highlight the  $X(t)$  by pressing **▶** and press **SHIFT** **◀** to swap the two parts of the expression, as shown at the right:

$$X(t) = \frac{\cos(t \cdot 2) - 2 \cdot \cos(t)}{2}$$

TOOL | ALGE | DIFF | REWR | SOLV | TRIG

Now select the entire expression and apply the

$$\text{DEF} \left( X(t) = \frac{\cos(t \cdot 2) - 2 \cdot \cos(t)}{2} \right)$$

TOOL | ALGE | DIFF | REWR | SOLV | TRIG

DEF command to it. Press **ENTER** to complete the definition.

To calculate the real part of the expression, apply the IM command (available on the COMPLEX submenu of the MATH menu) to the stored variable M.



Press **ENTER** to get the result at the right:

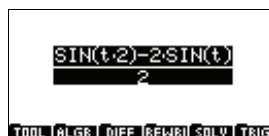

Finally, define the result as Y(t) in the same way that you defined X(t): by firstly adding `Y(t) =` to the expression (as shown at the right) and then applying the DEF command.

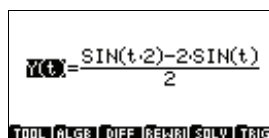

We have now found the coordinates of M in terms of t.

## Part 2

To find an axis of symmetry for  $\Gamma$ , calculate  $x(-t)$  and  $y(-t)$  by typing:

**ALPHA** X **(** **SHIFT**  
**ALPHA** t **▶** **(-)**

Press **▶** to highlight the expression.

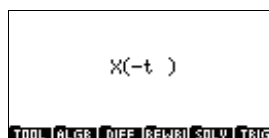

Then press **ENTER** to produce the result at the right:



In other words,  
 $x(-t) = x(t)$

Now type **ALPHA** Y **(** **SHIFT** **ALPHA** t **▶** **(-)**

Press **▶** to highlight the expression.

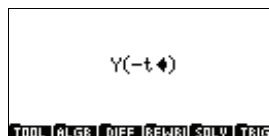

Then press **ENTER** to produce the result at the right:



In other words,  
 $y(-t) = -y(t)$ .

If  $M_1(x(t),y(t))$  is part of  $\Gamma$ , then  $M_x(x(-t),y(-t))$  is also part of  $\Gamma$ .

Since  $M_1$  and  $M_2$  are symmetrical with respect to the x-axis, we can deduce that the x-axis is an axis of symmetry for  $\Gamma$ .

### Part 3

Calculate  $x'(t)$  by typing:

**DIFF** **DERVX** **OK**  
**ALPHA** X **(** **SHIFT**  
**ALPHA** t. Press **▶** **▶**  
 to highlight the expression.



Pressing **ENTER** returns the result at the right:

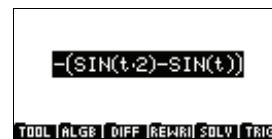

Press **ENTER** to simplify the result:

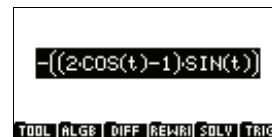

You can now define the function  $x'(t)$  by invoking **DEF**.

Note: You will first need to type =X1 (t) then exchange X1 (t) with the previous expression.

To do this, highlight X1(t) and type **SHIFT** **◀**.

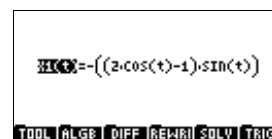

Now select the entire expression and apply the **DEF** command to it:

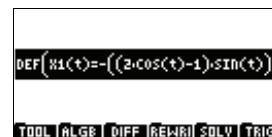

Finally press **ENTER** to finish the definition.



### Part 4

To calculate  $y'(t)$ , begin by typing: `DERVX(Y(t))`. Pressing `ENTER` returns:

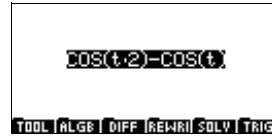

Press `ENTER` again to simplify the result:

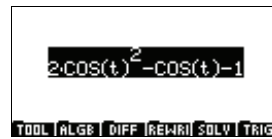

Select `FACTOR` and press `ENTER`.

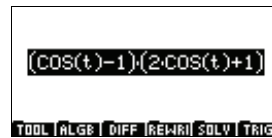

You can now define the function  $y'(t)$  (in the same way that you defined  $x'(t)$ ).

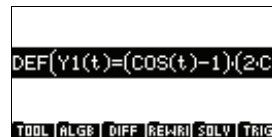

### Part 5

To show the variations of  $x(t)$  and  $y(t)$ , we will trace  $x(t)$  and  $y(t)$  on the same graph.

The independent variable must be  $t$  which it should be as a result of the previous calculations. (You can check this by pressing `SHIFT` `SYMB`.)

Type  $X(t)$  in the Equation Writer and press `ENTER`. The corresponding expression is displayed.



Now press `PLOT`, select Function, press `EXIT`, select `F1` as the destination and press `EXIT`.

Now do the same thing with  $Y(t)$ , making `F2` the destination.

To graph the functions, quit CAS (by pressing `HOME`), choose the Function applet, and check `F1` and `F2`.

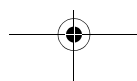
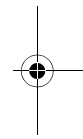
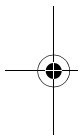
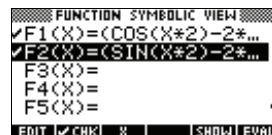



Now press **PLOT** to see the graphs.

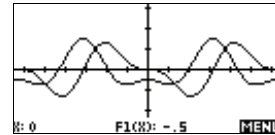

### Part 6

To find the values of  $x(t)$  and  $y(t)$  for  $t = 0, \frac{\pi}{3}, \frac{2 \cdot \pi}{3}, \pi$  return to CAS, type each function in turn and press **ENTER**. (You may need to press **ENTER** twice for further simplification).

For example, pressing

**ALPHA** X **( )** 0 **ENTER**

gives the result at the right:



Likewise, pressing **ALPHA**

X **( )** **SHIFT**  $\pi$  **÷** 3

**ENTER** **ENTER** gives this answer at the right:

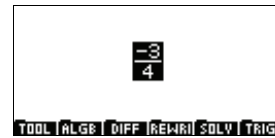

The other results are:

$$X\left(\frac{2\pi}{3}\right) = \frac{1}{4}$$

$$X(\pi) = \frac{3}{2}$$

$$Y(0) = 0$$

$$Y\left(\frac{\pi}{3}\right) = \frac{-\sqrt{3}}{4}$$

$$Y\left(\frac{2\pi}{3}\right) = \frac{-3 \cdot \sqrt{3}}{4}$$

$$Y(\pi) = 0$$

The slope of the tangents is  $m = \frac{y'(t)}{x'(t)}$ .

We can find the values of  $\frac{y'(t)}{x'(t)}$  for  $t = 0, \frac{\pi}{3}, \frac{2 \cdot \pi}{3}, \pi$  by using the **lim** command.

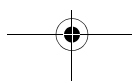



The example at the right shows the case for  $t = 0$ . Select the entire expression and press **ENTER** to get the answer:

$$\lim\left(\frac{Y1(t)}{X1(t)}, t=0\right)$$

TOOL ALGEB DIFF REWRIT SOLV TRIG

0

The example at the right shows the case for  $t = \pi/3$ .

$$\lim\left(\frac{Y1(t)}{X1(t)}, t=\frac{\pi}{3}\right)$$

TOOL ALGEB DIFF REWRIT SOLV TRIG

Selecting the entire expression and pressing **ENTER** displays the message shown at the right. Accept YES and press **EXIT**. Press **ENTER** again to get the result:

UNSIGNED INF. SOLVE?  
YES  
NO

CANCL OK

$\infty$

The next example is for  $t = 2\pi/3$ . Selecting the entire expression and pressing **ENTER** displays the result:

$$\lim\left(\frac{Y1(t)}{X1(t)}, t=\frac{2\pi}{3}\right)$$

TOOL ALGEB DIFF REWRIT SOLV TRIG

0

The final example is for the case where  $t = \pi$ . Press **ENTER**, accept YES to the message UNSIGNED INF. SOLVE?, press **EXIT** and press **ENTER** to get the result:

$$\lim\left(\frac{Y1(t)}{X1(t)}, t=\pi\right)$$

TOOL ALGEB DIFF REWRIT SOLV TRIG

$\infty$

Here, then, are the variations of  $x(t)$  and  $y(t)$  :

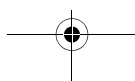
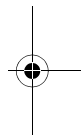
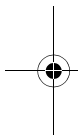

$t$	0		$\frac{\pi}{3}$		$\frac{2\pi}{3}$		$\pi$
$x'(t)$	0	-	0	+	$\sqrt{3}$	+	0
$x(t)$	$-\frac{1}{2}$	↓	$-\frac{3}{4}$	↑	$\frac{1}{4}$	↑	$\frac{3}{2}$
$y(t)$	0	↓	$-\frac{\sqrt{3}}{4}$	↓	$-\frac{3\sqrt{3}}{4}$	↑	0
$y'(t)$	0	-	-1	-	0	+	2
$m$	0		$\infty$		0		$\infty$

Now we will graph  $\Gamma$ , which is a parametric curve.

In the Equation Writer, type  $X(t) + i \times Y(t)$ .

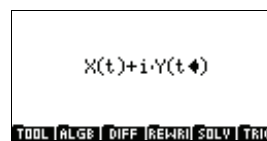

Select the entire expression and press **ENTER**.



Now press **PLOT**, select Parametric and press **DI**. Select X1, Y1 as the destination and press **DI**.

To make the graph of  $\Gamma$ , quit CAS and choose the Parametric aplet. Check X1(T) and Y1(T).

Now press **PLOT** to see the graph.

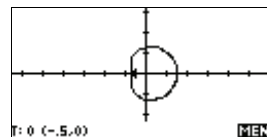

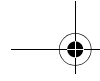
**Exercise 8**

For this exercise, make sure that the calculator is in exact real mode with  $X$  as the current variable.

**Part 1**

For an integer,  $n$ , define the following:

$$u_n = \int_0^2 \frac{2x+3}{x+2} e^{\frac{x}{n}} dx$$

Define  $g$  over  $[0,2]$  where:

$$g(x) = \frac{2x+3}{x+2}$$

1. Find the variations of  $g$  over  $[0,2]$ . Show that for every real  $x$  in  $[0,2]$ :

$$\frac{3}{2} \leq g(x) \leq \frac{7}{4}$$

2. Show that for every real  $x$  in  $[0,2]$ :

$$\frac{3}{2} e^{\frac{x}{n}} \leq g(x) e^{\frac{x}{n}} \leq \frac{7}{4} e^{\frac{x}{n}}$$

3. After integration, show that:

$$\frac{3}{2} \left( n e^{\frac{2}{n}} - n \right) \leq u_n \leq \frac{7}{4} \left( n e^{\frac{2}{n}} - n \right)$$

4. Using:

$$\lim_{x \rightarrow 0} \frac{e^x - 1}{x} = 1$$

show that if  $u_n$  has a limit  $L$  as  $n$  approaches infinity, then:

$$3 \leq L \leq \frac{7}{2}$$

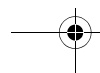
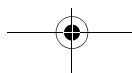
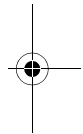
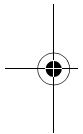



### Solution 1

Start by defining G(X):

$\boxed{\text{ALG}}$   $\boxed{\text{DEF}}$   $\boxed{\text{ALPHA}}$   $\boxed{G}$   
 $\boxed{\text{C}}$   $\boxed{\text{ALPHA}}$   $\boxed{X}$   $\boxed{\text{R}} \rightarrow$   
 $\boxed{\text{SHIFT}}$   $\boxed{=}$   $\boxed{2}$   $\boxed{\text{ALPHA}}$   $\boxed{X}$   
 $\boxed{+}$   $\boxed{3}$   $\boxed{\text{R}} \rightarrow$   $\boxed{\div}$   $\boxed{\text{ALPHA}}$   
 $\boxed{X}$   $\boxed{+}$   $\boxed{2}$

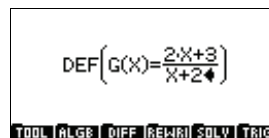

Now press  $\boxed{\text{ENTER}}$  :

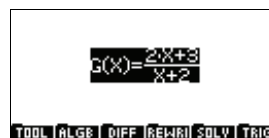

Press  $\boxed{\text{V}}$  and  $\boxed{\text{R}} \rightarrow$  to select the numerator and denominator, and then press  $\boxed{\text{SHIFT}}$   $\boxed{\text{DEL}}$ . This leaves G(X) displayed:



Finally, apply the TABVAR function:

$\boxed{\text{DIFF}}$   $\boxed{\text{TABVAR}}$   $\boxed{\text{M}}$

and press  $\boxed{\text{ENTER}}$  a number of times until the variation table appears (shown above).

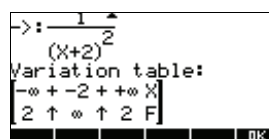

The first line of the variation table gives the sign of  $g'(x)$  according to  $x$ , and the second line the variations of  $g(x)$ . Note that for TABVAR the function is always called F.

We can deduce, then, that  $g(x)$  increases over  $[0, 2]$ .

If you had been in step-by-step mode, you would have obtained:

$$F = \frac{2 \cdot X + 3}{X + 2}$$

Press  $\boxed{\text{ENTER}}$  to get the result at the right.

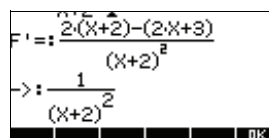



Now press  $\blacktriangledown$  and scroll down the screen to:

$$\rightarrow \frac{1}{(x+2)^2}$$

Now press  $\text{ENTER}$  to obtain the table of variations.

If you are not in step-by-step mode, you can also get the calculation of the derivative by typing:

DERVX ( G ( X ) )

which produces the preceding result.

To prove the stated inequality, first calculate  $g(0)$  by typing  $G(0)$  and pressing  $\text{ENTER}$ . The answer is:  $\frac{3}{2}$ .

Now calculate  $g(2)$  by typing  $G(2)$  and pressing  $\text{ENTER}$ . The answer is  $\frac{7}{4}$ .

The two results prove that:

$$\frac{3}{2} \leq g(x) \leq \frac{7}{4} \text{ for } x \in [0,2]$$

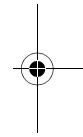
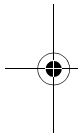

### Solution 2

The calculator is not needed here. Simply stating that:

$$e^{\frac{x}{n}} \geq 0 \text{ for } x \in [0,2]$$

is sufficient to show that, for  $x \in [0,2]$ , we have:

$$\frac{3}{2} e^{\frac{x}{n}} \leq g(x) e^{\frac{x}{n}} \leq \frac{7}{4} e^{\frac{x}{n}}$$

### Solution 3

To integrate the preceding inequality, type the expression at the right:

Pressing  $\text{ENTER}$  produces the result at the right:

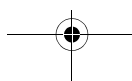

We can now see that:

$$\frac{3}{2} \left( n e^{\frac{2}{n}} - n \right) \leq u_n \leq \frac{7}{4} \left( n e^{\frac{2}{n}} - n \right)$$

To justify the preceding calculation, we must assume that  $n \cdot e^{\frac{x}{n}}$  is a primitive of  $e^{\frac{x}{n}}$ .

If you are not sure, you can use the `INTVX` function as illustrated at the right:

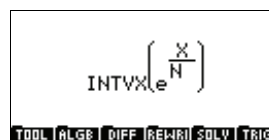

Note that the `INTVX` command is on the `DIFF` menu.



The simplified result, got by pressing `ENTER` twice, is shown at the right:



**Solution 4**  
To find the limit of  $\left( n e^{\frac{2}{n}} - n \right)$  when  $n \rightarrow +\infty$ , enter the expression at the right:

Note that the `lim` command is on the `DIFF` menu. The infinity sign can be selected from the character map, opened by pressing `SHIFT` `[VARS]`.

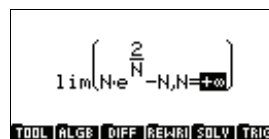

Pressing `ENTER` once after selecting the infinity sign adds a "+" character to the infinity sign.

Select the entire expression and press `ENTER` to get the result, which is:



2

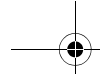

**NOTE:** The variable  $VX$  is now set to  $N$ . Reset it to  $X$  by pressing  $\text{[SHIFT] [SYMB]}$  (to display CAS MODES screen) and change the INDEP VAR setting.

To check the result, we can say that:

$$\lim_{x \rightarrow 0} \frac{e^x - 1}{x} = 1$$

and that therefore:

$$\lim_{n \rightarrow +\infty} \frac{e^{\frac{2}{n}} - 1}{\frac{2}{n}} = 1$$

or, simplifying:

$$\lim_{n \rightarrow +\infty} \left( e^{\frac{2}{n}} - 1 \right) \cdot n = 2$$

If the limit  $L$  of  $u_n$  exists as  $n$  approaches  $+\infty$  in the inequalities in solution 2 above, we get:

$$\frac{3}{2} \cdot 2 \leq L \leq \frac{7}{4} \cdot 2$$

## Part 2

1. Show that for every  $x$  in  $[0, 2]$ :

$$\frac{2x+3}{x+2} = 2 - \frac{1}{x+2}$$

2. Find the value of:

$$I = \int_0^2 \frac{2x+3}{x+2} dx$$

3. Show that for every  $x$  in  $[0, 2]$ :

$$1 \leq e^{\frac{x}{n}} \leq e^{\frac{2}{n}}$$

4. Deduce that:

$$1 \leq u_n \leq e^{\frac{2}{n}} \cdot I$$

5. Show that  $u_n$  is convergent and find its limit,  $L$ .

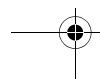
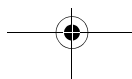
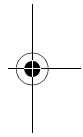
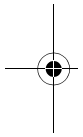

**Solution 1**

Start by defining the following:  $g(x) = 2 - \frac{1}{x+2}$

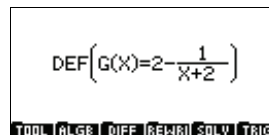

Now type `PROPFrac(G(X))`. Note that `PROPFrac` can be found on the `POLYNOMIAL` submenu of the `MATH` menu.

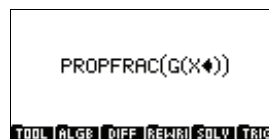

Pressing `ENTER` yields the result shown at the right.

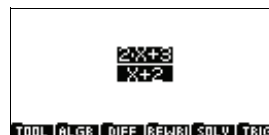

**Solution 2**

Enter the integral:

$$I = \int_0^2 g(x) dx$$

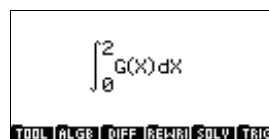

Pressing `ENTER` yields the result shown at the right:

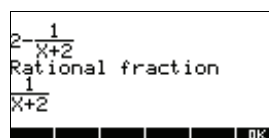

Pressing `ENTER` again yields:

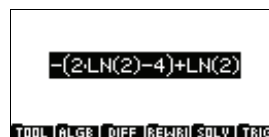

Working by hand:

$$2x + 3 = 2(x + 2) - 1, \text{ so: } g(x) = 2 - \frac{1}{x + 2}$$

Then, integrating term by term between 0 and 2 produces:

$$\int_0^2 g(x) dx = [2x - \ln(x + 2)] \Big|_{x=0}^{x=2}$$

that is, since  $\ln 4 = 2 \ln 2$  :

$$\int_0^2 g(x) dx = 4 - \ln 2$$

**Solution 3**

The calculator is not needed here. Simply stating that  $e^{\frac{x}{n}}$  increases for  $x \in [0,2]$  is sufficient to yield the inequality:

$$1 \leq e^{\frac{x}{n}} \leq e^{\frac{2}{n}}$$

**Solution 4**

Since  $g(x)$  is positive over  $[0, 2]$ , through multiplication we get:

$$g(x) \leq g(x)e^{\frac{x}{n}} \leq g(x)e^{\frac{2}{n}}$$

and then, integrating:

$$I \leq u_n \leq e^{\frac{2}{n}} I$$

**Solution 5**  
First find the limit of  $e^{\frac{2}{n}}$  when  $n \rightarrow +\infty$ .

Note: pressing **ENTER** after you have selected the infinity sign from the character map places a "+" character in front of the infinity sign.

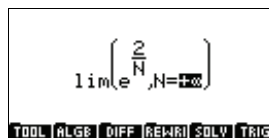

Selecting the entire expression and pressing **ENTER** yields:



In effect,  $\frac{2}{n}$  tends to 0 as  $n$  tends to  $+\infty$ , so  $e^{\frac{2}{n}}$  tends to  $e^0 = 1$  as  $n$  tends to  $+\infty$ .

As  $n$  tends to  $+\infty$ ,  $u_n$  is the portion between  $I$  and a quantity that tends to  $I$ .

Hence,  $u_n$  converges, and its limit is  $I$ .

We have therefore shown that:  $L = I = 4 - \ln 2$

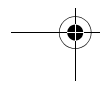
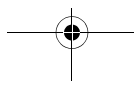
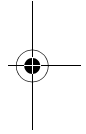
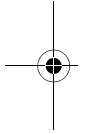
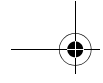

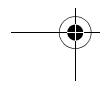
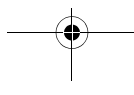
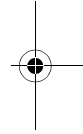
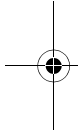
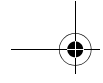



## Variables and memory management

---

### Introduction

The HP 40gs has approximately 200K of user memory. The calculator uses this memory to store variables, perform computations, and store history.

A variable is an object that you create in memory to hold data. The HP 40gs has two types of variables, home variables and aplet variables.

- Home variables are available in all aplets. For example, you can store real numbers in variables A to Z and complex numbers in variables Z0 to Z9. These can be numbers you have entered, or the results of calculations. These variables are available within all aplets and within any programs.
- Aplet variables apply only to a single aplet. Aplets have specific variables allocated to them which vary from aplet to aplet.

You use the calculator's memory to store the following objects:

- copies of aplets with specific configurations
- new aplets that you download
- aplet variables
- home variables
- variables created through a catalog or editor, for example a matrix or a text note
- programs that you create.

You can use the Memory Manager (`[SHIFT] MEMORY`) to view the amount of memory available. The catalog views, which are accessible via the Memory Manager, can be used to transfer variables such as lists or matrices between calculators.



## Storing and recalling variables

You can store numbers or expressions from a previous input or result into variables.

### Numeric Precision

A number stored in a variable is always stored as a 12-digit mantissa with a 3-digit exponent. Numeric precision in the display, however, depends on the display mode (Standard, Fixed, Scientific, Engineering, or Fraction). A displayed number has only the precision that is displayed. If you copy it from the HOME view display history, you obtain only the precision displayed, not the full internal precision. On the other hand, the variable *Ans* always contains the most recent result to full precision.

### To store a value

1. On the command line, enter the value or the calculation for the result you wish to store.
2. Press **STO**.
3. Enter a name for the variable.
4. Press **ENTER**.

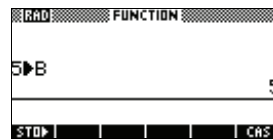
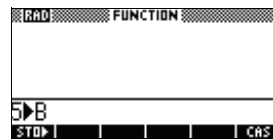

### To store the results of a calculation

If the value you want to store is in the HOME view display history, for example the results of a previous calculation, you need to copy it to the command line, then store it.

1. Perform the calculation for the result you want to store.

3 **(x)** ( **( )** 8 **(x)** 6 **( )**  
**(X<sup>Y</sup>)** 3 **ENTER**

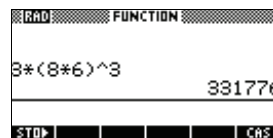

2. Press **(▲)** to highlight to the result you wish to store.
3. Press **COPY** to copy the result to the command line.
4. Press **STO**.



5. Enter a name for the variable.

**[ALPHA]** A



6. Press **[ENTER]** to store the result.

The results of a calculation can also be stored directly to a variable. For example:

2 **[x<sup>y</sup>]** ( 5 **[÷]** 3 **)**

**[STO]** **[ALPHA]** B

**[ENTER]**

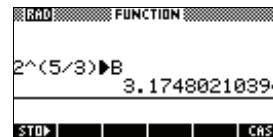

### To recall a value

To recall a variable's value, type the name of the variable and press **[ENTER]**.

**[ALPHA]** A **[ENTER]**

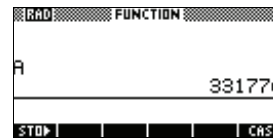

### To use variables in calculations

You can use variables in calculations. The calculator substitutes the variable's value in the calculation:

65 **[+]** **[ALPHA]** A **[ENTER]**

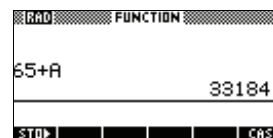

### To clear a variable

You can use the CLRVAR command to clear a specified variable. For example, if you have stored {1,2,3,4} in variable L1, entering CLRVAR L1

**[ENTER]** will clear L1. (You can find the CLRVAR command by pressing **[SHIFT]** **[MATH]** and choosing the PROMPT category of commands.)

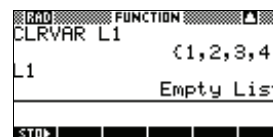

## The VARS menu

You use the VARS menu to access all variables in the calculator. The VARS menu is organised by category. For each variable category in the left column, there is a list of variables in the right column. You select a variable category and then select a variable in the category.

1. Open the VARS menu.

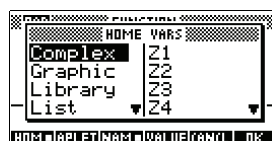

2. Use the arrow keys or press the alpha key of the first letter in the category to select a variable category.

*For example, to select the Matrix category, press .*

*Note: In this instance, there is no need to press the ALPHA key.*



3. Move the highlight to the variables column.

4. Use the arrow keys to select the variable that you want. For example, to select the M2 variable, press



5. Choose whether to place the variable name or the variable value on the command line.
  - Press **VALUE** to indicate that you want the variable's contents to appear on the command line.
  - Press **NAME** to indicate that you want the variable's name to appear on the command line.
6. Press **VAR** to place the value or name on the command line. The selected object appears on the command line.

**VAR**



*Note: The VARS menu can also be used to enter the names or values of variables into programs.*

### Example

This example demonstrates how to use the VARS menu to add the contents of two list variables, and to store the result in another list variable.

1. Display the List Catalog.

**SHIFT** LIST  
to select L1  
**EDIT**

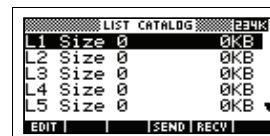

2. Enter the data for L1.

88 **OK** 90 **OK** 89 **OK**  
65 **OK** 70 **OK**

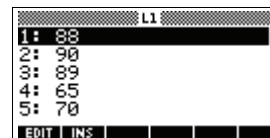

3. Return to the List Catalog to create L2.

**SHIFT** LIST  
▼ to select L2  
**EDIT**



4. Enter data for L2.

55  $\square$  48  $\square$  86  $\square$   
 90  $\square$  77  $\square$



5. Press  $\square$  to access HOME.

6. Open the variable menu and select L1.

$\square$   $\square$   $\square$   $\square$   $\square$



7. Copy it to the command line. *Note: Because the  $\square$  option is highlighted, the variable's name, rather than its contents, is copied to the command line.*

$\square$

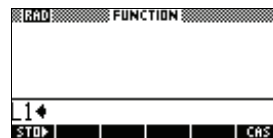

8. Insert the + operator and select the L2 variable from the List variables.

$\square$   $\square$   $\square$   $\square$   $\square$   $\square$   $\square$



9. Store the answer in the List catalog L3 variable.

$\square$   $\square$  L3

$\square$

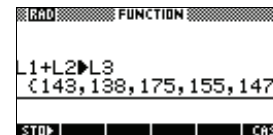

*Note: You can also type list names directly from the keyboard.*

## Home variables

It is not possible to store data of one type in a variable of another type. For example, you use the Matrix catalog to create matrices. You can create up to ten matrices, and you can store these in variables M0 to M9. You cannot store matrices in variables other than M0 to M9.

Category	Available names
Complex	Z0 to Z9 For example, $(1,2)$ <b>STO</b> Z0 or $2+3i$ <b>STO</b> Z1. You can enter a complex number by typing $(r;i)$ , where $r$ represents the real part, and $i$ represents the imaginary part.
Graphic	G0 to G9 See "Graphic commands" on page 21-21 for more information on storing graphic objects via programming commands. See "To store into a graphics variable" on page 20-5 for more information on storing graphic object via the sketch view.
Library	Aplet library variables can store aplets that you have created, either by saving a copy of a standard aplet, or downloading an aplet from another source.
List	L0 to L9 For example, $\{1,2,3\}$ <b>STO</b> L1.
Matrix	M0 to M9 can store matrices or vectors. For example, $[[1,2],[3,4]]$ <b>STO</b> M0.
Modes	Modes variables store the modes settings that you can configure using <b>SHIFT</b> <b>MODES</b> .
Notepad	Notepad variables store notes.
Program	Program variables store programs.
Real	A to Z and $\theta$ . For example, 7.45 <b>STO</b> A.
Symbolic	E0...9, S1...S5, s1...s5 and n1...n5.



## Aplet variables

Most aplet variables store values that are unique to a particular aplet. These include symbolic expressions and equations (see below), settings for the Plot and Numeric views, and the results of some calculations such as roots and intersections.

See the Reference Information chapter for more information about aplet variables.

Category	Available names
Function	F0 to F9 (Symbolic view). See "Function aplet variables" on page R-7.
Parametric	X0, Y0 to X9, Y9 (Symbolic view). See "Parametric aplet variables" on page R-8.
Polar	R0 to R9 (Symbolic view). See "Polar aplet variables" on page R-9.
Sequence	U0 to U9 (Symbolic view). See "Sequence aplet variables" on page R-10.
Solve	E0 to E9 (Symbolic view). See "Solve aplet variables" on page R-11.
Statistics	C0 to C9 (Numeric view). See "Statistics aplet variables" on page R-12.

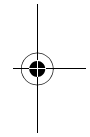
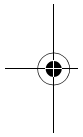

### To access an aplet variable

1. Open the aplet that contains the variable you want to recall.
2. Press **[VARS]** to display the VARS menu.
3. Use the arrow keys to select a variable category in the left column, then press **[▶]** to access the variables in the right column.
4. Use the arrow keys to select a variable in the right column.
5. To copy the name of the variable onto the edit line, press **[F1]**. (**[NAME]** is the default setting.)
6. To copy the value of the variable into the edit line, press **[VALUE]** and press **[F1]**.

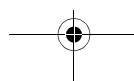





## Memory Manager

You can use the Memory Manager to determine the amount of available memory on the calculator. You can also use Memory Manager to organize memory. For example, if the available memory is low, you can use the Memory Manager to determine which aplets or variables consume large amounts of memory. You can make deletions to free up memory.

### Example

1. Start the Memory Manager. A list of variable categories is displayed.

`[SHIFT] MEMORY`

Free memory is displayed in the top right corner and the body of the screen lists each category, the memory it uses, and the percentage of the total memory it uses.

MEMORY MANAGER		198KB
Aplets	.1KB	<1%
Programs	0KB	<1%
Notes	0KB	<1%
Matrices	0KB	<1%
Lists	.1KB	<1%
		VIEW

2. Select the category with which you want to work and press `[VIEW]`. Memory Manager displays memory details of variables within the category.

`[▼] [▼] [▼] [VIEW]`

MATRIX CATALOG		198KB
M1	1x1 REAL MATRIX	0KB
M2	1x1 REAL MATRIX	0KB
M3	1x1 REAL MATRIX	0KB
M4	1x1 REAL MATRIX	0KB
M5	1x1 REAL MATRIX	0KB
EDIT   NEW		SEND   RECV

3. To delete variables in a category:

- Press `[DEL]` to delete the selected variable.
- Press `[SHIFT] CLEAR` to delete all variables in the selected category.

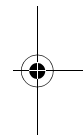
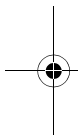

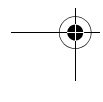
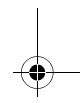
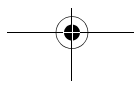
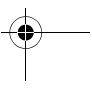
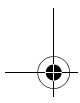
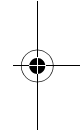
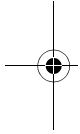
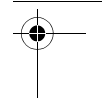
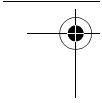
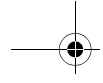

## Matrices

---

### Introduction

You can perform matrix calculations in HOME and in programs. The matrix *and each row* of a matrix appear in brackets, and the elements and rows are separated by commas. For example, the following matrix:

$$\begin{bmatrix} 1 & 2 & 3 \\ 4 & 5 & 6 \end{bmatrix}$$

is displayed in the history as:  
[[1,2,3],[4,5,6]]

(If the Decimal Mark mode is set to `Comma`, then separate each element and each row with a period.)

You can enter matrices directly in the command line, or create them in the matrix editor.

### Vectors

Vectors are one-dimensional arrays. They are composed of just one row. A vector is represented with single brackets; for example, [1,2,3]. A vector can be a real number vector or a complex number vector, for example [(1,2), (7,3)].

### Matrices

Matrices are two-dimensional arrays. They are composed of more than one row and more than one column. Two-dimensional matrices are represented with nested brackets; for example, [[1,2,3],[4,5,6]]. You can create complex matrices, for example, [[[1,2), (3,4)], [(4,5), (6,7)]]].

### Matrix Variables

There are ten matrix variables available, named M0 to M9. You can use them in calculations in HOME or in a program. You can retrieve the matrix names from the VARS menu, or just type their names from the keyboard.

## Creating and storing matrices

You can create, edit, delete, send, and receive matrices in the Matrix catalog.



To open the Matrix catalog, press  $\text{[SHIFT] MATRIX}$ .

You can also create and store matrices—named or unnamed—in HOME. For example, the command:

```
POLYROOT([1, 0, -1, 0]) ► M1
```

stores the root of the complex vector of length 3 into the M1 variable. M1 now contains the three roots of  $x^3 - x = 0$

### Matrix Catalog keys

The table below lists the operations of the menu keys in the Matrix Catalog, as well as the use of Delete ( $\text{[DEL]}$ ) and Clear ( $\text{[SHIFT] CLEAR}$ ).

Key	Meaning
$\text{[EDIT]}$	Opens the highlighted matrix for editing.
$\text{[NEW]}$	Prompts for a matrix type, then opens an empty matrix with the highlighted name.
$\text{[SEND]}$	Transmits the highlighted matrix to another HP 40gs or a disk drive. See .
$\text{[RECU]}$	Receives a matrix from another HP 40gs or a disk drive. See .
$\text{[DEL]}$	Clears the highlighted matrix.
$\text{[SHIFT] CLEAR}$	Clears all matrices.
$\text{[SHIFT] } \downarrow \text{ or } \uparrow$	Moves to the end or the beginning of the catalog.

### To create a matrix in the Matrix Catalog

1. Press  $\text{[SHIFT] MATRIX}$  to open the Matrix Catalog. The Matrix catalog lists the 10 available matrix variables, M0 to M9.

2. Highlight the matrix variable name you want to use and press **NEW**.
3. Select the type of matrix to create.
  - **For a vector (one-dimensional array)**, select Real vector or Complex vector. Certain operations (+, −, CROSS) do not recognize a one-dimensional matrix as a vector, so this selection is important.
  - **For a matrix (two-dimensional array)**, select Real matrix or Complex matrix.
4. For each element in the matrix, type a number or an expression, and press **ENTER**. (The expression may not contain symbolic variable names.)
 

**For complex numbers**, enter each number in complex form; that is,  $(a, b)$ , where  $a$  is the real part and  $b$  is the imaginary part. You must include the parentheses and the comma.
5. Use the cursor keys to move to a different row or column. You can change the direction of the highlight bar by pressing **FOV**. The **FOV** menu key toggles between the following three options:
  - **FOV↓** specifies that the cursor moves to the cell below the current cell when you press **ENTER**.
  - **FOV→** specifies that the cursor moves to the cell to the right of the current cell when you press **ENTER**.
  - **FOV** specifies that the cursor stays in the current cell when you press **ENTER**.
6. When done, press **SHIFT** **MATRIX** to see the Matrix catalog, or press **HOME** to return to HOME. The matrix entries are automatically stored.

M2	1	2	3
1	25	56	14
2	89	-27	23

EDIT | INS | GO→ | BIG

MATRIX CATALOG		EDIT
M1	1x1 REAL MATRIX	OKB
M2	2x3 REAL MATRIX	OKB
M3	1x1 REAL MATRIX	OKB
M4	1x1 REAL MATRIX	OKB
M5	1x1 REAL MATRIX	OKB

EDIT | NEW | SEND | RECV

A matrix is listed with two dimensions, even if it is  $3 \times 1$ . A vector is listed with the number of elements, such as 3.



### To transmit a matrix

You can send matrices between calculators just as you can send aplets, programs, lists, and notes.

1. Connect the calculators using an appropriate cable.
2. Open the Matrix catalogs on both calculators.
3. Highlight the matrix to send.
4. Press **SEND** and choose the method of sending.
5. Press **RECV** on the receiving calculator and choose the method of receiving.

For more information on sending and receiving files, see "Sending and receiving aplets" on page 22-4.

## Working with matrices

### To edit a matrix

In the Matrix catalog, highlight the name of the matrix you want to edit and press **EDIT**.

### Matrix edit keys

The following table lists the matrix edit key operations.

Key	Meaning
<b>EDIT</b>	Copies the highlighted element to the edit line.
<b>INS</b>	Inserts a row of zeros above, or a column of zeros to the left, of the highlighted cell. (You are prompted to choose row or column.)
<b>GO</b>	A three-way toggle for cursor advancement in the Matrix editor. <b>GO+</b> advances to the right, <b>GO-</b> advances downward, and <b>GO</b> does not advance at all.
<b>BIG</b>	Switches between larger and smaller font sizes.
<b>DEL</b>	Deletes the highlighted cells, row, or column (you are prompted to make a choice).
<b>SHIFT CLEAR</b>	Clears all elements from the matrix.

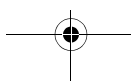
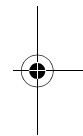
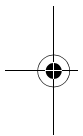

Key	Meaning (Continued)
$\left[ \text{SHIFT} \right] \left[ \blacktriangle \right]$ $\left[ \blacktriangledown \right] \left[ \blacktriangleright \right] \left[ \blacktriangleleft \right]$	Moves to the first row, last row, first column, or last column respectively.

### To display a matrix

- In the Matrix catalog ( $\left[ \text{SHIFT} \right] \text{MATRIX}$ ), highlight the matrix name and press  $\left[ \text{EDIT} \right]$ .
- In HOME, enter the name of the matrix variable and press  $\left[ \text{ENTER} \right]$ .

### To display one element

In HOME, enter  $\text{matrixname}(\text{row}, \text{column})$ . For example, if M2 is  $[[3, 4], [5, 6]]$ , then  $\text{M2}(1, 2) \left[ \text{ENTER} \right]$  returns 4.

### To create a matrix in HOME

1. Enter the matrix in the edit line. Start and end the matrix *and each row* with square brackets (the shifted  $\left[ 5 \right]$  and  $\left[ 6 \right]$  keys).
2. Separate each element *and each row* with a comma. Example:  $[[1, 2], [3, 4]]$ .
3. Press  $\left[ \text{ENTER} \right]$  to enter and display the matrix.

The left screen below shows the matrix  $[[2.5, 729], [16, 2]]$  being stored into M5. The screen on the right shows the vector  $[66, 33, 11]$  being stored into M6. Note that you can enter an expression (like  $5/2$ ) for an element of the matrix, and it will be evaluated.

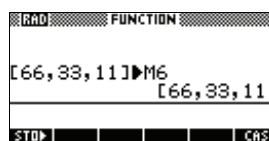
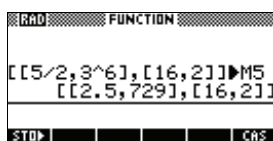



### To store one element

In HOME, enter, value **STO** matrixname(row, column). For example, to change the element in the first row and second column of M5 to 728, then display the resulting matrix:

728 **STO** **ALPHA**  
 M5 **(** 1 **,** 2 **)** **ENTER**  
**ALPHA** M5 **ENTER**.

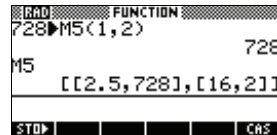

An attempt to store an element to a row or column beyond the size of the matrix results in an error message.

## Matrix arithmetic

You can use the arithmetic functions (+, -, ×, / and powers) with matrix arguments. Division left-multiplies by the inverse of the divisor. You can enter the matrices themselves or enter the names of stored matrix variables. The matrices can be real or complex.

For the next examples, store [[1,2],[3,4]] into M1 and [[5,6],[7,8]] into M2.

### Example

1. Create the first matrix.

**SHIFT** **MATRIX** **NEW**  
**0** 1 **ENTER** 2 **ENTER**  
**▼** 3 **ENTER** 4  
**ENTER**

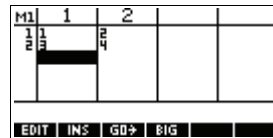

2. Create the second matrix.

**SHIFT** **MATRIX** **▼**  
**NEW** **0** 5 **ENTER** 6  
**ENTER** **▼** 7 **ENTER**  
 8 **ENTER**

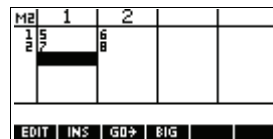

3. Add the matrices that you created.

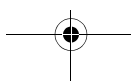
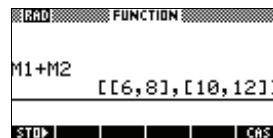



`HOME` `ALPHA` `M1` `+` `ALPHA` `M2` `ENTER`

### To multiply and divide by a scalar

For division by a scalar, enter the matrix first, then the operator, then the scalar. For multiplication, the order of the operands does not matter.

The matrix and the scalar can be real or complex. For example, to divide the result of the previous example by 2, press the following keys:

`÷` `2` `ENTER`

```

RAD  FUNCTION
M1+M2  [[6,8],[10,12]]
Ans/2   [[3,4],[5,6]]
STO>   CAS
    
```

### To multiply two matrices

To multiply the two matrices M1 and M2 that you created for the previous example, press the following keys:

`ALPHA` `M1` `×` `ALPHA` `M2` `ENTER`

```

RAD  FUNCTION
Ans/2  [[3,4],[5,6]]
M1*M2  [[19,22],[43,50]]
STO>   CAS
    
```

To multiply a matrix by a vector, enter the matrix first, then the vector. The number of elements in the vector must equal the number of columns in the matrix.

### To raise a matrix to a power

You can raise a matrix to any power as long as the power is an integer. The following example shows the result of raising matrix M1, created earlier, to the power of 5.

`ALPHA` `M1` `XY` `5` `ENTER`

```

RAD  FUNCTION
M1^5  [[1069,1558],[2337,34..]]
STO>   CAS
    
```

*Note:* You can also raise a matrix to a power without first storing it as a variable.

Matrices can be raised to negative powers. In this case, the result is equivalent to  $1/[\text{matrix}]^{\text{ABS}(\text{power})}$ . In the following example, M1 is raised to the power of -2.

`ALPHA` `M1` `XY` `(-)` `2` `ENTER`

```

RAD  FUNCTION
M1^-2  [[5.5,-2.5],[-3.75,1..]]
STO>   CAS
    
```



### To divide by a square matrix

For division of a matrix or a vector by a square matrix, the number of rows of the dividend (or the number of elements, if it is a vector) must equal the number of rows in the divisor.

This operation is not a mathematical division: it is a left-multiplication by the inverse of the divisor.  $M1/M2$  is equivalent to  $M2^{-1} * M1$ .

To divide the two matrices  $M1$  and  $M2$  that you created for the previous example, press the following keys:

**[ALPHA]** M1 **[÷]**  
**[ALPHA]** M2 **[ENTER]**

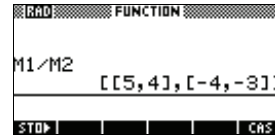

### To invert a matrix

You can invert a *square matrix* in HOME by typing the matrix (or its variable name) and pressing **[SHIFT]**  $x^{-1}$  **[ENTER]**. Or you can use the matrix INVERSE command. Enter INVERSE (*matrixname*) in HOME and press **[ENTER]**.

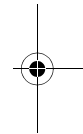
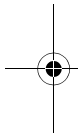

### To negate each element

You can change the sign of each element in a matrix by pressing **[(-)]** before the matrix name.

## Solving systems of linear equations

### Example

Solve the following linear system:

$$\begin{aligned} 2x + 3y + 4z &= 5 \\ x + y - z &= 7 \\ 4x - y + 2z &= 1 \end{aligned}$$

1. Open the Matrix catalog and create a vector.

**[SHIFT]** MATRIX **[NEW]**

**[v]** **[ENTER]**



2. Create the vector of the constants in the linear system.

5 **[ENTER]** 7 **[ENTER]**

1 **[ENTER]**

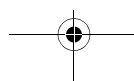
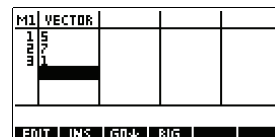

3. Return to the Matrix Catalog.

$\text{[SHIFT] MATRIX}$

In this example, the vector you created is listed as M1.

MATRIX CATALOG		EDIT
M1	3 REAL VECTOR	.08KB
M2	1x1 REAL MATRIX	0KB
M3	1x1 REAL MATRIX	0KB
M4	1x1 REAL MATRIX	0KB
M5	2x2 REAL MATRIX	.04KB
EDIT   NEW		SEND   RECV

4. Create a new matrix.

$\text{[v] NEW}$

Select Real matrix

$\text{[OK]}$

CREATE NEW...		EDIT
M1	Real matrix	8
M2	Real vector	8
M3	Complex matrix	8
M4	Complex matrix	8
M5	Complex vector	8
EDIT   INS		CANCEL   OK

5. Enter the equation coefficients.

2  $\text{[ENTER]}$  3  $\text{[ENTER]}$

4  $\text{[ENTER]}$   $\text{[v]}$

1  $\text{[ENTER]}$  1  $\text{[ENTER]}$

$\text{[(-)]}$  1  $\text{[ENTER]}$  4  $\text{[ENTER]}$

$\text{[(-)]}$  1  $\text{[ENTER]}$  2  $\text{[ENTER]}$

M2	1	2	3	
1	2	3	4	
2	1	-1	-1	
3			2	
EDIT   INS   GO $\rightarrow$   BIG				

In this example, the matrix you created is listed as M2.

6. Return to HOME and enter the calculation to left-multiply the constants vector by the inverse of the coefficients matrix.

$\text{[HOME]}$   $\text{[ALPHA]}$  M2

$\text{[SHIFT]}$   $x^{-1}$   $\text{[x]}$

$\text{[ALPHA]}$  M1  $\text{[ENTER]}$

FUNCTION	
M2 <sup>-1</sup> *M1	[2, 3, -2]
STO $\rightarrow$   CAS	

The result is a vector of the solutions  $x = 2$ ,  $y = 3$  and  $z = -2$ .

An alternative method, is to use the RREF function. See "RREF" on page 18-12.



## Matrix functions and commands

### About functions

- Functions can be used in any aplet or in HOME. They are listed in the MATH menu under the Matrix category. They can be used in mathematical expressions—primarily in HOME—as well as in programs.
- Functions always produce and display a result. They do not change any stored variables, such as a matrix variable.
- Functions have arguments that are enclosed in parentheses and separated by commas; for example, `CROSS(vector1,vector2)`. The matrix input can be either a matrix variable name (such as `M1`) or the actual matrix data inside brackets. For example, `CROSS(M1,[1,2])`.

### About commands

Matrix commands are listed in the CMDS menu (`SHIFT` `CMDS`), in the matrix category.

See “Matrix commands” on page 21-24 for details of the matrix commands available for use in programming.

Functions differ from commands in that a function can be used in an expression. Commands cannot be used in an expression.

### Argument conventions

- For *row#* or *column#*, supply the number of the row (counting from the top, starting with 1) or the number of the column (counting from the left, starting with 1).
- The argument *matrix* can refer to either a vector or a matrix.

### Matrix functions

#### COLNORM

Column Norm. Finds the maximum value (over all columns) of the sums of the absolute values of all elements in a column.

`COLNORM(matrix)`

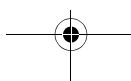
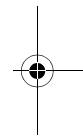
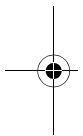



**COND** Condition Number. Finds the 1-norm (column norm) of a square *matrix*.

`COND(matrix)`

**CROSS** Cross Product of *vector1* with *vector2*.

`CROSS(vector1, vector2)`

**DET** Determinant of a square *matrix*.

`DET(matrix)`

**DOT** Dot Product of two arrays, *matrix1* *matrix2*.

`DOT(matrix1, matrix2)`

**EIGENVAL** Displays the eigenvalues in vector form for *matrix*.

`EIGENVAL(matrix)`

**EIGENVV** Eigenvectors and Eigenvalues for a square *matrix*. Displays a list of two arrays. The first contains the eigenvectors and the second contains the eigenvalues.

`EIGENVV(matrix)`

**IDENMAT** Identity matrix. Creates a square matrix of dimension *size* × *size* whose diagonal elements are 1 and off-diagonal elements are zero.

`IDENMAT(size)`

**INVERSE** Inverts a square matrix (real or complex).

`INVERSE(matrix)`

**LQ** LQ Factorization. Factors an  $m \times n$  *matrix* into three matrices:

`{[[  $m \times n$  lowertrapezoidal]], [[  $n \times n$  orthogonal]], [[  $m \times m$  permutation]]}`.

`LQ(matrix)`

**LSQ** Least Squares. Displays the minimum norm least squares *matrix* (or *vector*).

`LSQ(matrix1, matrix2)`

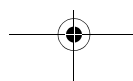
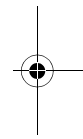
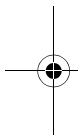

**LU**

LU Decomposition. Factors a square *matrix* into three matrices:  
 {{{lowertriangular}},[[uppertriangular]],[[permutation]]}  
 The *uppertriangular* has ones on its diagonal.

LU(*matrix*)

**MAKEMAT**

Make Matrix. Creates a matrix of dimension *rows* × *columns*, using *expression* to calculate each element. If *expression* contains the variables I and J, then the calculation for each element substitutes the current row number for I and the current column number for J.

MAKEMAT(*expression*, *rows*, *columns*)

Example

MAKEMAT(0, 3, 3) returns a 3×3 zero matrix,  
 [[0,0,0],[0,0,0],[0,0,0]].

**QR**

QR Factorization. Factors an  $m \times n$  *matrix* into three matrices: {{{[m×m orthogonal]},[[m×n uppertrapezoidal]],[[n×n permutation]]}.

QR(*matrix*)

**RANK**

Rank of a rectangular *matrix*.

RANK(*matrix*)

**ROWNORM**

Row Norm. Finds the maximum value (over all rows) for the sums of the absolute values of all elements in a row.

ROWNORM(*matrix*)

**RREF**

Reduced-Row Echelon Form. Changes a rectangular *matrix* to its reduced row-echelon form.

RREF(*matrix*)

**SCHUR**

Schur Decomposition. Factors a square *matrix* into two matrices. If *matrix* is real, then the result is {{{orthogonal}},[[upper-quasi triangular]]}. If *matrix* is complex, then the result is {{{unitary}},[[upper-triangular]]}.

SCHUR(*matrix*)

**SIZE**

Dimensions of *matrix*. Returned as a list: {rows,columns}.

SIZE(*matrix*)

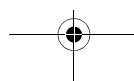
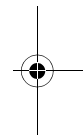
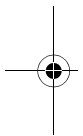

**SPECNORM**Spectral Norm of *matrix*.SPECNORM(*matrix*)**SPECRAD**Spectral Radius of a square *matrix*.SPECRAD(*matrix*)**SVD**Singular Value Decomposition. Factors an  $m \times n$  *matrix* into two matrices and a vector:  
{[[ $m \times m$  square orthogonal]], [[ $n \times n$  square orthogonal]], [real]}.SVD(*matrix*)**SVL**Singular Values. Returns a vector containing the singular values of *matrix*.SVL(*matrix*)**TRACE**Finds the trace of a square *matrix*. The trace is equal to the sum of the diagonal elements. (It is also equal to the sum of the eigenvalues.)TRACE(*matrix*)**TRN**Transposes *matrix*. For a complex matrix, TRN finds the conjugate transpose.TRN(*matrix*)

## Examples

**Identity Matrix**You can create an identity matrix with the IDENMAT function. For example, IDENMAT(2) creates the  $2 \times 2$  identity matrix [[1,0],[0,1]].You can also create an identity matrix using the MAKEMAT (*make matrix*) function. For example, entering MAKEMAT(I¼J,4,4) creates a  $4 \times 4$  matrix showing the numeral 1 for all elements except zeros on the diagonal. The logical operator ¼ returns 0 when I (the row number) and J (the column number) are equal, and returns 1 when they are not equal.**Transposing a Matrix**

The TRN function swaps the row-column and column-row elements of a matrix. For instance, element 1,2 (row 1,

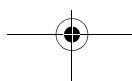
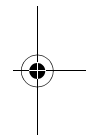
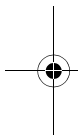



### Reduced-Row Echelon Form

column 2) is swapped with element 2,1; element 2,3 is swapped with element 3,2; and so on.

For example,  $\text{TRN}([ [1, 2], [3, 4] ])$  creates the matrix  $[ [1, 3], [2, 4] ]$ .

The following set of equations 
$$\begin{aligned} x - 2y + 3z &= 14 \\ 2x + y - z &= -3 \\ 4x - 2y + 2z &= 14 \end{aligned}$$

can be written as the augmented matrix

$$\left[ \begin{array}{ccc|c} 1 & -2 & 3 & 14 \\ 2 & 1 & -1 & -3 \\ 4 & -2 & 2 & 14 \end{array} \right]$$

which can then stored as a  $3 \times 4$  real matrix in any matrix variable. M1 is used in this example.

M1	1	2	3	4
1	1	-2	3	14
2	2	1	-1	-3
3	4	-2	2	14

1  
EDIT INE GD+ BIG

You can use the RREF function to change this to reduced row echelon form, storing it in any matrix variable. M2 is used in this example.

RAD:	FUNCTION:
RREF(M1)M2	
[[1,0,0,1],[0,1,0,-2]..	

STO CAS

The reduced row echelon matrix gives the solution to the linear equation in the fourth column.

M2	1	2	3	4
1	1	0	0	1
2	0	1	0	-2
3	0	0	1	3

EDIT INE GD+ BIG

An advantage of using the RREF function is that it will also work with inconsistent matrices resulting from systems of equations which have no solution or infinite solutions.

For example, the following set of equations has an infinite number of solutions:

$$\begin{aligned} x + y - z &= 5 \\ 2x - y &= 7 \\ x - 2y + z &= 2 \end{aligned}$$







The final row of zeros in the reduced-row echelon form of the augmented matrix indicates an inconsistent system with infinite solutions.

M2	1	2	3	4
1	1	0	- .33333	4
2	0	1	- .66667	1
3	0	0	0	0

1

EDIT INE GO B/G

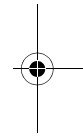
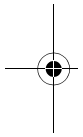

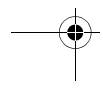
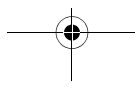
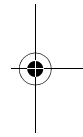
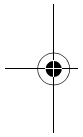
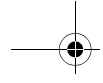

## Lists

You can do list operations in HOME and in programs. A list consists of comma-separated real or complex numbers, expressions, or matrices, all enclosed in braces. A list may, for example, contain a sequence of real numbers such as  $\{1, 2, 3\}$ . (If the Decimal Mark mode is set to *Comma*, then the separators are periods.) Lists represent a convenient way to group related objects.

There are ten list variables available, named L0 to L9. You can use them in calculations or expressions in HOME or in a program. Retrieve the list names from the VARS menu, or just type their names from the keyboard.

You can create, edit, delete, send, and receive named lists in the List catalog ( $\text{[SHIFT] LIST}$ ). You can also create and store lists—named or unnamed—in HOME lists

List variables are identical in behaviour to the columns C1.C0 in the Statistics aplet. You can store a statistics column to a list (or vice versa) and use any of the list functions on the statistics columns, or the statistics functions, on the list variables.

### Create a list in the List Catalog

1. Open the List catalog.

$\text{[SHIFT] LIST}$ .

LIST CATALOG	SIZE	MEM
L1	Size 5	0KB
L2	Size 5	0KB
L3	Size 5	0KB
L4	Size 0	0KB
L5	Size 0	0KB

2. Highlight the list name you want to assign to the new list (L1, etc.) and press  $\text{[EDIT]}$  to display the List editor.

L1
Empty List

$\text{[EDIT]}$



3. Enter the values you want in the list, pressing **ENTER** after each one.

Values can be real or complex numbers (or an expression). If you enter a calculation, it is evaluated and the result is inserted in the list.

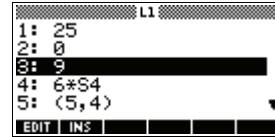

4. When done, press **SHIFT** *LIST* to see the List catalog, or press **HOME** to return to HOME.

### List catalog keys

The list catalog keys are:

Key	Meaning
<b>EDIT</b>	Opens the highlighted list for editing.
<b>SEND</b>	Transmits the highlighted list to another HP 40gs or a PC. See "Sending and receiving aplets" on page 22-4 for further information.
<b>RECV</b>	Receives a list from another HP 40gs or a PC. See "Sending and receiving aplets" on page 22-4 for further information.
<b>DEL</b>	Clears the highlighted list.
<b>SHIFT</b> <i>CLEAR</i>	Clears all lists.
<b>SHIFT</b> <b>▼</b> or <b>▲</b>	Moves to the end or the beginning of the catalog.

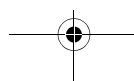
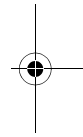
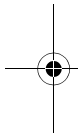



## List edit keys

When you press **EDIT** to create or change a list, the following keys are available to you:

Key	Meaning
<b>EDIT</b>	Copies the highlighted list item into the edit line.
<b>INS</b>	Inserts a new value before the highlighted item.
<b>DEL</b>	Deletes the highlighted item from the list.
<b>SHIFT CLEAR</b>	Clears all elements from the list.
<b>SHIFT</b> <b>▼</b> or <b>▲</b>	Moves to the end or the beginning of the list.

## Create a list in HOME

1. Enter the list on the edit line. Start and end the list with braces (the shifted **8** and **9** keys) and separate each element with a comma.
2. Press **ENTER** to evaluate and display the list.

Immediately after typing in the list, you can store it in a variable by pressing **EDIT** *listname* **ENTER**. The list variable names are L0 through L9.

This example stores the list {25,147,8} in L1.

*Note: You can omit the final brace when entering a list.*

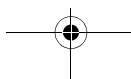
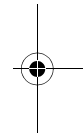
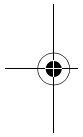
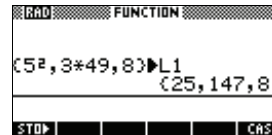

## Displaying and editing lists

### To display a list

- In the List catalog, highlight the list name and press **EDIT**.
- In HOME, enter the name of the list and press **ENTER**.

### To display one element

In HOME, enter *listname(element#)*. For example, if L2 is {3,4,5,6}, then `L2(2)` **ENTER** returns 4.

### To edit a list

1. Open the List catalog.

**SHIFT** **LIST**.



2. Press **▲** or **▼** to highlight the name of the list you want to edit (L1, etc.) and press **EDIT** to display the list contents.

**EDIT**



3. Press **▲** or **▼** to highlight the element you want to edit. In this example, edit the third element so that it has a value of 5.

**▼** **▼** **EDIT**

**DEL** **DEL**

5



4. Press **OK**.



### To insert an element in a list

1. Open the List catalog.

**SHIFT** **LIST**.

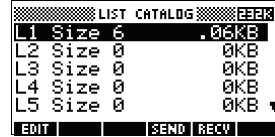

2. Press **▲** or **▼** to highlight the name of the list you want to edit (L1, etc.) and press **EDIT** to display the list contents.



New elements are inserted above the highlighted position. In this example, an element, with the value of 9, is inserted between the first and second elements in the list.

3. Press **▼** to the insertion position, then press **INS**, and press 9.



4. Press **INS**.

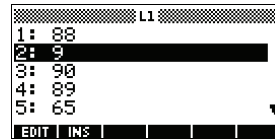

### To store one element

In HOME, enter value **STORE** *listname(element)*. For example, to store 148 as the second element in L1, type 148 **STORE** L1 (2) **ENTER**.

## Deleting lists

### To delete a list

In the List catalog, highlight the list name and press **[DEL]**. You are prompted to confirm that you want to delete the contents of the highlighted list variable. Press **[ENTER]** to delete the contents.

### To delete all lists

In the List catalog, press **[SHIFT]** **CLEAR**.

## Transmitting lists

You can send lists to calculators or PCs just as you can aplets, programs, matrices, and notes.

1. Connect the calculators using an appropriate cable).
2. Open the List catalogs on both calculators.
3. Highlight the list to send.
4. Press **[SEND]** and choose the method of sending.
5. Press **[RECV]** on the receiving calculator and choose the method of receiving.

For more information on sending and receiving files, see "Sending and receiving aplets" on page 22-4.

## List functions

List functions are found in the MATH menu. You can use them in HOME, as well as in programs.

You can type in the name of the function, or you can copy the name of the function from the List category of the MATH menu. Press **[MATH]** **[L]** (the alpha L character key). This



highlights the List category in the left column. Press **[▶]** to move the cursor to the right column which contain the List functions, select a function, and press **[EXE]**.

List functions have the following syntax:

- Functions have arguments that are enclosed in parentheses and separated by commas. Example: `CONCAT (L1, L2)`. An argument can be either a list



variable name (such as L1) or the actual list. For example, `REVERSE({1,2,3})`.

- If Decimal Mark in Modes is set to Comma, use periods to separate arguments. For example, `CONCAT(L1.L2)`.

Common operators like  $+$ ,  $-$ ,  $\times$ , and  $/$  can take lists as arguments. If there are two arguments and both are lists, then the lists must have the same length, since the calculation pairs the elements. If there are two arguments and one is a real number, then the calculation pairs the number with each element of the list.

**Example**

`5 * {1,2,3}` returns `{5,10,15}`.

Besides the common operators that can take numbers, matrices, or lists as arguments, there are commands that can only operate on lists.

**CONCAT**

Concatenates two lists into a new list.

`CONCAT(list1,list2)`

**Example**

`CONCAT({1,2,3},{4})` returns `{1,2,3,4}`.

**$\Delta$ LIST**

Creates a new list composed of the first differences, that is, the differences between the sequential elements in *list1*. The new list has one fewer elements than *list1*. The first differences for  $\{x_1, x_2, \dots, x_n\}$  are  $\{x_2 - x_1, \dots, x_n - x_{n-1}\}$ .

`$\Delta$ LIST(list1)`

**Example**

In HOME, store `{3,5,8,12,17,23}` in L5 and find the first differences for the list.

<code>[HOME]</code> <code>[SHIFT]</code>	
<code>{3,5,8,12,17,23</code>	
<code>[SHIFT]</code> <code>[LIST]</code> <code>[ALPHA]</code>	
<code>L 5</code> <code>[ENTER]</code>	
<code>[MATH]</code> <code>L</code> <code>[▶]</code>	
Select <code><math>\Delta</math>LIST</code> <code>[]</code>	
<code>[ALPHA]</code> <code>L5</code> <code>[ENTER]</code>	



## MAKELIST

Calculates a sequence of elements for a new list. Evaluates *expression* with *variable* from *begin* to *end* values, taken at *increment* steps.

`MAKELIST (expression, variable, begin, end, increment)`

The MAKELIST function generates a series by automatically producing a list from the repeated evaluation of an expression.

### Example

In HOME, generate a series of squares from 23 to 27.

`[MATH] L [▶] Select`  
`MAKELIST [MATH]`  
`[ALPHA] A [X2]`  
`[,] [ALPHA] A [,] 23 [,]`  
`27 [,] 1 [)] [ENTER]`

READ	FUNCTION
MAKELIST(A <sup>2</sup> ,A,23,27,1)	
{529,576,625,676,729}	
STOP	CAS

## ΠLIST

Calculates the product of all elements in list.

`ΠLIST (list)`

### Example

`ΠLIST ({2, 3, 4})` returns 24.

## POS

Returns the position of an element within a list. The *element* can be a value, a variable, or an expression. If there is more than one instance of the element, the position of the first occurrence is returned. A value of 0 is returned if there is no occurrence of the specified element.

`POS (list, element)`

### Example

`POS ({3, 7, 12, 19}, 12)` returns 3

## REVERSE

Creates a list by reversing the order of the elements in a list.

`REVERSE (list)`

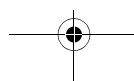



## SIZE

Calculates the number of elements in a list.

$SIZE(list)$

Also works with matrices.

## $\Sigma$ LIST

Calculates the sum of all elements in list.

$\Sigma LIST(list)$

### Example

$\Sigma LIST(\{2, 3, 4\})$  returns 9.

## SORT

Sorts elements in ascending order.

$SORT(list)$

## Finding statistical values for list elements

To find values such as the mean, median, maximum, and minimum values of the elements in a list, use the Statistics aplet.

### Example

In this example, use the Statistics aplet to find the mean, median, maximum, and minimum values of the elements in the list, L1.

1. Create L1 with values 88, 90, 89, 65, 70, and 89.

$\boxed{SHIFT} \{ 88 \boxed{,} 90 \boxed{,}$   
 $89 \boxed{,} 65 \boxed{,} 70 \boxed{,} 89$   
 $\boxed{SHIFT} \} \boxed{ENTER}$   
 $\boxed{ALPHA} L1$

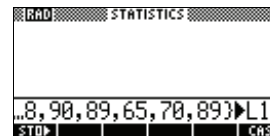

$\boxed{ENTER}$

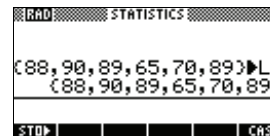

2. In HOME, store L1 into C1. You will then be able to see the list data in the Numeric view of the Statistics aplet.

$\boxed{ALPHA} L1$   
 $\boxed{STORE} \boxed{ALPHA} C1$   
 $\boxed{ENTER}$

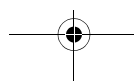
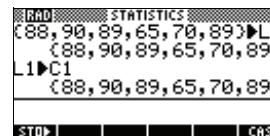

3. Start the Statistics aplet, and select 1-variable mode (press **APLET**, if necessary, to display **STATS**).

**APLET** Select  
Statistics  
**STATS**

n	C1	C2	C3	C4
1	88			
2	40			
3	89			
4	55			
5	79			
6	89			
88				

EDIT INS SORT BIG AVAR STATS

*Note: Your list values are now in column 1 (C1).*

4. In the Symbolic view, define H1 (for example) as C1 (sample) and 1 (frequency).

**SYMB**

STATISTICS SYMBOLIC VIEW

✓H1:	C1	1
H2:		
H3:		
H4:		

ENTER SAMPLE  
EDIT ✓CHK C SHOW EVAL

5. Go to the Numeric view to display calculated statistics.

**NUM** **STATS**

1-VAR	H1		
NΣ	6		
TOTΣ	441		
MEANΣ	81.83333		
VARΣ	105.1389		
STDEVΣ	10.25373		
PSDEV	10.25373		
6			

OK

See "One-variable" on page 10-14 for the meaning of each computed statistic.



## 20

# Notes and sketches

---

## Introduction

The HP 40gs has text and picture editors for entering notes and sketches.

- Each aplet has its own independent **Note view** and **Sketch view**. Notes and sketches that you create in these views are associated with the aplet. When you save the aplet, or send it to another calculator, the notes and sketches are saved or sent as well.
- The **Notepad** is a collection of notes independent of all aplets. These notes can also be sent to another calculator via the Notepad Catalog.

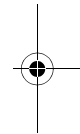
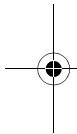

## Aplet note view

You can attach text to an aplet in its Note view.

### To write a note in Note view

1. In an aplet, press **[SHIFT]NOTE** for the Note view.
2. Use the note editing keys shown in the table in the following section.
3. Set Alpha lock (**[ALPHA]**) for quick entry of letters. For lowercase Alpha lock, press **[SHIFT] [ALPHA]**.
4. While Alpha lock is on:
  - To type a single letter of the opposite case, press **[SHIFT] letter**.
  - To type a single non-alpha character (such as 5 or [ ), press **[ALPHA]** first. (This turns off Alpha lock for one character.)

*Your work is automatically saved.* Press any view key (**[NUM]**, **[SYMB]**, **[PLOT]**, **[VIEWS]**) or **[HOME]** to exit the Notes view.

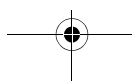



### Note edit keys

Key	Meaning
<b>SPACE</b>	Space key for text entry.
<b>PAGE</b>	Displays next page of a multi-page note.
<b>A...2</b>	Alpha-lock for letter entry.
<b>SHIFT</b> <b>A...2</b>	Lower-case alpha-lock for letter entry.
<b>BACKSP</b>	Backspaces cursor and deletes character.
<b>DEL</b>	Deletes current character.
<b>ENTER</b>	Starts a new line.
<b>SHIFT</b> <i>CLEAR</i>	Erases the entire note.
<b>VAR</b>	Menu for entering variable names, and contents of variables.
<b>MATH</b>	Menu for entering math operations, and constants.
<b>SHIFT</b> <i>CMDS</i>	Menu for entering program commands.
<b>SHIFT</b> <i>CHARS</i>	Displays special characters. To type one, highlight it and press <b>OK</b> . To copy a character <i>without</i> closing the CHARS screen, press <b>ECHO</b> .

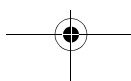
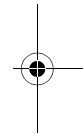
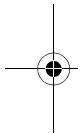



## Aplet sketch view

You can attach pictures to an aplet in its Sketch view (**SHIFT** *SKETCH*). Your work is automatically saved with the aplet. Press any other view key or **HOME** to exit the Sketch view

### Sketch keys

Key	Meaning
<b>STOP</b>	Stores the specified portion of the current sketch to a graphics variable (G1 through G0).
<b>NEW</b>	Adds a new, blank page to the current sketch set.
<b>PAGE</b>	Displays next sketch in the sketch set. Animates if held down.
<b>TEXT</b>	Opens the edit line to type a text label.
<b>DRAW</b>	Displays the menu-key labels for drawing.
<b>DEL</b>	Deletes the current sketch.
<b>SHIFT</b> <i>CLEAR</i>	Erases the entire sketch set.
<b>-</b>	Toggles menu key labels on and off. If menu key labels are hidden, <b>-</b> or any menu key, redisplay the menu key labels.

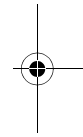
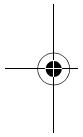

### To draw a line

1. In an aplet, press **SHIFT** *SKETCH* for the Sketch view.
2. In Sketch view, press **DRAW** and move the cursor to where you want to start the line
3. Press **LINE**. This turns on line-drawing.
4. Move the cursor in any direction to the end point of the line by pressing the **▲**, **▼**, **▶**, **◀** keys.
5. Press **OK** to finish the line.

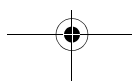



### To draw a box

1. In Sketch view, press **DRAW** and move the cursor to where you want any corner of the box to be.
2. Press **BOX**.
3. Move the cursor to mark the opposite corner for the box. You can adjust the size of the box by moving the cursor.
4. Press **OK** to finish the box.

### To draw a circle

1. In Sketch view, press **DRAW** and move the cursor to where you want the center of the circle to be.
2. Press **CIRCL**. This turns on circle drawing.
3. Move the cursor the distance of the radius.
4. Press **OK** to draw the circle.

### DRAW keys

Key	Meaning
<b>DOT+</b>	Dot on. Turns pixels on as the cursor moves.
<b>DOT-</b>	Dot off. Turns pixels off as the cursor moves.
<b>LINE</b>	Draws a line from the cursor's starting position to the cursor's current position. Press <b>OK</b> when you have finished. You can draw a line at any angle.
<b>BOX</b>	Draws a box from the cursor's starting position to the cursor's current position. Press <b>OK</b> when you have finished.
<b>CIRCL</b>	Draws a circle with the cursor's starting position as the center. The radius is the distance between the cursor's starting and ending position. Press <b>OK</b> to draw the circle.

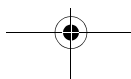
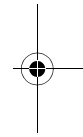
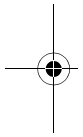





### To label parts of a sketch

1. Press **TEXT** and type the text on the edit line. To lock the Alpha shift on, press **ALPHA** (for uppercase) or **SHIFT** **ALPHA** (for lowercase).

To make the label a smaller character size, turn off **SIZE** before pressing **ALPHA**. (**SIZE** is a toggle between small and large font size). The smaller character size cannot display lowercase letters.

2. Press **OK**.
3. Position the label where you want it by pressing the **▲**, **▼**, **▶**, **◀** keys.
4. Press **OK** again to affix the label.
5. Press **DRAW** to continue drawing, or press **HOME** to exit the Sketch view.

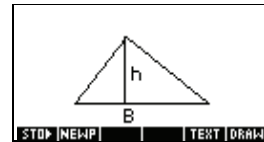

### To create a set of sketches

You can create a set of up to ten sketches. This allows for simple animation.

- After making a sketch, press **NEWP** to add a new, blank page. You can now make a new sketch, which becomes part of the current set of sketches.
- To view the next sketch in an existing set, press **PAGE▶**. Hold **PAGE▶** down for animation.
- To remove the current page in the current sketch series, press **DEL**.

### To store into a graphics variable

You can define a portion of a sketch inside a box, and then store that graphic into a graphics variable.

1. In the Sketch view, display the sketch you want to copy (store into a variable).
2. Press **STOP**.
3. Highlight the variable name you want to use and press **OK**.
4. Draw a box around the portion you want to copy: move the cursor to one corner, press **OK**, then move the cursor to the opposite corner, and press **OK**.

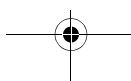
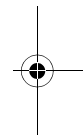
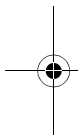



### To import a graphics variable

You can copy the contents of a graphics variable into the Sketch view of an aplet.

1. Open the Sketch view of the aplet (**SHIFT** SKETCH). The graphic will be copied here.
2. Press **VAR**, **HOME**.
3. Highlight **Graphic**, then press **▶** and highlight the name of the variable (**G1**, etc.).
4. Press **VALUE** **OK** to recall the contents of the graphics variable.
5. Move the box to where you would like to copy the graphic, then press **OK**.

## The notepad

Subject to available memory, you can store as many notes as you want in the Notepad (**SHIFT** NOTEPAD). These notes are independent of any aplet. The Notepad catalog lists the existing entries by name. *It does not include notes that were created in aplets' Note views, but these can be imported. See "To import a note" on page 20-8.*

### To create a note in the Notepad

1. Display the Notepad catalog.

**SHIFT** NOTEPAD



2. Create a new note.

**NEW**



3. Enter a name for your note.

**HOME** MYNOTE **OK**

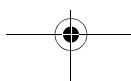



4. Write your note.

See "Note edit keys" on page 20-2 for more information on the entry and editing of notes.

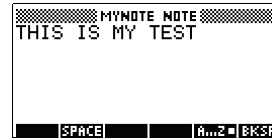

5. When you are finished, press **HOME** or an aplet key to exit Notepad. Your work is automatically saved.

### Notepad Catalog keys

Key	Meaning
<b>EDIT</b>	Opens the selected note for editing.
<b>NEW</b>	Begins a new note, and asks for a name.
<b>SEND</b>	Transmits the selected note to another HP 40gs or PC.
<b>RECV</b>	Receives a note being transmitted from another HP 40gs or PC.
<b>DEL</b>	Deletes the selected note.
<b>SHIFT CLEAR</b>	Deletes all notes in the catalog.

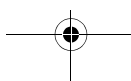
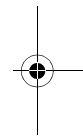
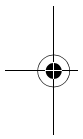



### To import a note

You can import a note from the Notepad into an aplet's Note view, and vice versa. Suppose you want to copy a note named "Assignments" from the Notepad into the Function Note view:

1. In the Function aplet, display the Note view (**SHIFT** **NOTE**).
2. Press **VAR** **HOME**, highlight **Note** in the left column, then highlight the name "Assignments" in the right column.
3. Press **VALUE** **OK** to copy the contents of "Assignments" to the Function Note view.

*Note: To recall the name instead of the contents, press **HOME** instead of **VALUE**.*

Suppose you want to copy the Note view from the current aplet into the note, Assignments, in the Notepad.

1. In the Notepad (**SHIFT** **NOTEPAD**), open the note, "Assignments".
2. Press **VAR** **APLET**, highlight **Note** in the left column, then press **▶** and highlight **NoteText** in the right column.
3. Press **VALUE** **OK** to recall the contents of the Note view into the note "Assignments".

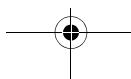
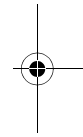
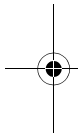



# Programming

---

## Introduction

This chapter describes how to program using the HP 40gs. In this chapter you'll learn about:

- using the Program catalog to create and edit programs
- programming commands
- storing and retrieving variables in programs
- programming variables.

### HINT

More information on programming, including examples and special tools, can be found at HP's calculators web site:

<http://www.hp.com/calculators>

## The Contents of a Program

An HP 40gs program contains a sequence of numbers, mathematical expressions, and commands that execute automatically to perform a task.

These items are separated by a colon (:). Commands that take multiple arguments have those arguments separated by a semicolon (;). For example,

`PIXON xposition ; yposition :`

## Structured Programming

Inside a program you can use branching structures to control the execution flow. You can take advantage of structured programming by creating building-block programs. Each building-block program stands alone—and it can be called from other programs. *Note: If a program has a space in its name then you have to put quotes around it when you want to run it.*

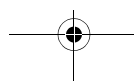
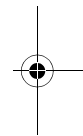
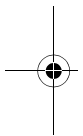



### Example

RUN GETVALUE: RUN CALCULATE: RUN  
"SHOW ANSWER":

This program is separated into three main tasks, each an individual program. Within each program, the task can be simple—or it can be divided further into other programs that perform smaller tasks.

## Program catalog

The Program catalog is where you create, edit, delete, send, receive, or run programs. This section describes how to

- open the Program catalog
- create a new program
- enter commands from the program commands menu
- enter functions from the MATH menu
- edit a program
- run and debug a program
- stop a program
- copy a program
- send and receive a program
- delete a program or its contents
- customize an aplet.

### Open Program Catalog

1. Press  $\boxed{\text{SHIFT}}$  *PROGRM*.

The Program Catalog displays a list of program names. The Program Catalog contains a built-in entry called *Editline*.

*Editline* contains the last expression that you entered from the edit line in HOME, or the last data you entered in an input form. (If you press  $\boxed{\text{ENTER}}$  from HOME without entering any data, the HP 40gs runs the contents of *Editline*.)

Before starting to work with programs, you should take a few minutes to become familiar with the Program catalog menu keys. You can use any of the following keys (both menu and keyboard), to perform tasks in the Program catalog.

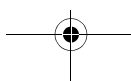



## Program catalog keys

The program catalog keys are:

Key	Meaning
<b>EDIT</b>	Opens the highlighted program for editing.
<b>NEW</b>	Prompts for a new program name, then opens an empty program.
<b>SEND</b>	Transmits the highlighted program to another HP 40gs or to a disk drive.
<b>RECV</b>	Receives the highlighted program from another HP 40gs or from a disk drive.
<b>RUN</b>	Runs the highlighted program.
<b>SHIFT</b> ▲ or ▼	Moves to the beginning or end of the Program catalog.
<b>DEL</b>	Deletes the highlighted program.
<b>SHIFT</b> CLEAR	Deletes all programs in the program catalog.

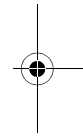
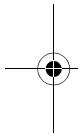

## Creating and editing programs

### Create a new program

1. Press **[SHIFT]PROGRAM** to open the Program catalog.
2. Press **[NEW]**.

The HP 40gs prompts you for a name.



A program name can contain special characters, such as a space. However, if you use special characters and then run the program by typing it in HOME, you must enclose the program name in double quotes (" "). Don't use the " symbol within your program name.

3. Type your program name, then press **[F1]**.

When you press **[F1]**, the Program Editor opens.



4. Enter your program. When done, start any other activity. Your work is saved automatically.

### Enter commands



Until you become familiar with the HP 40gs commands, the easiest way to enter commands is to select them from the Commands menu from the Program editor. You can also type in commands using alpha characters.

1. From the Program editor, press **[SHIFT]CMDS** to open the Program Commands menu.

**[SHIFT]CMDS**





- On the left, use  or  to highlight a command category, then press  to access the commands in the category. Select the command that you want.





- Press  to paste the command into the program editor.

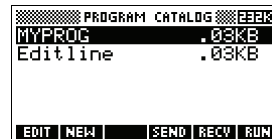

## Edit a program

- Press  *PROGRAM* to open the Program catalog.



- Use the arrow keys to highlight the program you want to edit, and press . The HP 40gs opens the Program Editor. The name of your program appears in the title bar of the display. You can use the following keys to edit your program.

## Editing keys

The editing keys are:

Key	Meaning
	Inserts the  character at the editing point.
	Inserts space into text.
	Displays previous page of the program.
	Displays next page of the program.
	Moves up or down one line.
	Moves right or left one character.
	Alpha-lock for letter entry. Press  A...Z to lock lower case.
	Backspaces cursor and deletes character.
	Deletes current character.
	Starts a new line.
CLEAR	Erases the entire program.
	Displays menus for selecting variable names, contents of variables, math functions, and program constants.
CMDS	Displays menus for selecting program commands.
CHARS	Displays all characters. To type one, highlight it and press  . To enter several characters in a row, use the  menu key while in the CHARS menu.



## Using programs

### Run a program

From HOME, type `RUN program_name`.

or

From the Program catalog, highlight the program you want to run and press **▶▶▶**

*Regardless of where you start the program, all programs run in HOME. What you see will differ slightly depending on where you started the program. If you start the program from HOME, the HP 40gs displays the contents of `Ans` (Home variable containing the last result), when the program has finished. If you start the program from the Program catalog, the HP 40gs returns you to the Program catalog when the program ends.*

### Debug a program

If you run a program that contains errors, the program will stop and you will see an error message.



To debug the program:

1. Press **EDIT** to edit the program.

The insert cursor appears in the program at the point where the error occurred.

2. Edit the program to fix the error.
3. Run the program.
4. Repeat the process until you correct all errors.

### Stop a program

You can stop the running of a program at any time by pressing `CANCEL` (the **ON** key). *Note: You may have to press it a couple of times.*

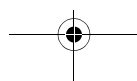



## Copy a program

You can use the following procedure if you want to make a copy of your work before editing—or if you want to use one program as a template for another.

1. Press  $\boxed{\text{SHIFT}} \boxed{\text{PROGRM}}$  to open the Program catalog.
2. Press  $\boxed{\text{NEW}}$ .
3. Type a new file name, then choose  $\boxed{\text{OK}}$ .  
The Program Editor opens with a new program.
4. Press  $\boxed{\text{VARS}}$  to open the variables menu.
5. Press  $\boxed{7}$  to quickly scroll to Program.
6. Press  $\boxed{\text{▶}}$ , then highlight the program you want to copy.
7. Press  $\boxed{\text{WRITE}}$ , then press  $\boxed{\text{OK}}$ .  
The contents of the highlighted program are copied into the current program at the cursor location.

### HINT

---

If you use a programming routine often, save the routine under a different program name, then use the above method to copy it into your programs.

---

## Transmit a program

You can send programs to, and receive programs from, other calculators just as you can send and receive aplets, matrices, lists, and notes.

After connecting the calculators with an appropriate cable, open the Program catalogs on both calculators. Highlight the program to send, then press  $\boxed{\text{SEND}}$  on the sending calculator and  $\boxed{\text{RECV}}$  on the receiving calculator.

You can also send programs to, and receive programs from, a remote storage device (aplet disk drive or computer). This takes place via a cable connection and requires an aplet disk drive or specialized software running on a PC (such as a connectivity kit).

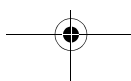
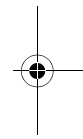
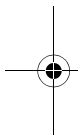



## Delete a program

To delete a program:

1. Press **[SHIFT] PROGRAM** to open the Program catalog.
2. Highlight a program to delete, then press **[DEL]**.

## Delete all programs

You can delete all programs at once.

1. In the Program catalog, press **[SHIFT] CLEAR**.
2. Press **[YES]**.

## Delete the contents of a program

You can clear the contents of a program without deleting the program name.

1. Press **[SHIFT] PROGRAM** to open the Program catalog.
2. Highlight a program, then press **[EDIT]**.
3. Press **[SHIFT] CLEAR**, then press **[YES]**.
4. The contents of the program are deleted, but the program name remains.

## Customizing an aplet

You can customize an aplet and develop a set of programs to work with the aplet.

Use the SETVIEWS command to create a custom VIEWS menu which links specially written programs to the new aplet.

A useful method for customizing an aplet is illustrated below:

1. Decide on the built-in aplet that you want to customize. For example you could customize the Function aplet or the Statistics aplet. The customized aplet inherits all the properties of the built-in aplet. Save the customized aplet with a unique name.
2. Customize the new aplet if you need to, for example by presetting axes or angle measures.
3. Develop the programs to work with your customized aplet. When you develop the aplet's programs, use the standard aplet naming convention. This allows you to keep track of the programs in the Program catalog that belong to each aplet. See "Aplet naming convention" on page 21-10.

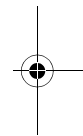
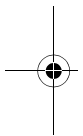



4. Develop a program that uses the SETVIEWS command to modify the aplet's VIEWS menu. The menu options provide links to associated programs. You can specify any other programs that you want transferred with the aplet. See "SETVIEWS" on page 21-14 for information on the command.
5. Ensure that the customized aplet is selected, then run the menu configuration program to configure the aplet's VIEWS menu.
6. Test the customized aplet and debug the associated programs. (Refer to "Debug a program" on page 16-7).

## Aplet naming convention

To assist users in keeping track of aplets and associated programs, use the following naming convention when setting up an aplet's programs:

- Start all program names with an abbreviation of the aplet name. We will use APL in this example.
- Name programs called by menu entries in the VIEWS menu number, after the entry, for example:
  - APL.ME1 for the program called by menu option 1
  - APL.ME2 for the program called by menu option 2
- Name the program that configures the new VIEWS menu option APL.SV where SV stands for SETVIEWS.

For example, a customized aplet called "Differentiation" might call programs called DIFF.ME1, DIFF.ME2, and DIFF.SV.

## Example

This example aplet is designed to demonstrate the process of customizing an aplet. The new aplet is based on the Function aplet. *Note: This aplet is not intended to serve a serious use, merely to illustrate the process.*

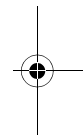
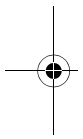



## Save the aplet

1. Open the Function aplet and save it as "EXPERIMENT". The new aplet appears in the Aplet library.

```

[APLET] Select
Function [F1]
[ALPHA] EXPERIMENT

```



2. Create a program called EXP.ME1 with contents as shown. This program configures the plot ranges, then runs a program that allows you to set the angle format.

```

EXP.ME1 PROGRAM
-10 Xmin:
10 Xmax:
-5 Ymin:
5 Ymax:
RUN "EXP.ANG":

```

3. Create a program called EXP.ME2 with contents as shown. This program sets the numeric view options for the aplet, and runs the program that you can use to configure the angle mode.

```

EXP.ME2 PROGRAM
10 NumStart:
2 NumStep:
MSGBOX "Numeric
values set.":
RUN "EXP.ANG":

```

4. Create a program called EXP.ANG which the previous two programs call.

```

EXP.ANG PROGRAM
1 C:
CHOOSE C: "ANGLE
MEASURE":
"Degrees":
"Radians": "Grads":
C Angle:

```

5. Create a program called EXP.S which runs when you start the aplet, as shown. This program sets the angle mode to degrees, and sets up the initial function that the aplet plots.

```

EXP.S PROGRAM
1 Angle:
X2-2 F1(X):
CHECK 1:

```

## Configuring the Setviews menu option programs

In this section we will begin by configuring the VIEWS menu by using the SETVIEWS command. We will then create the "helper" programs called by the VIEWS menu which will do the actual work.

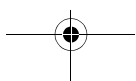



6. Open the Program catalog and create a program named "EXP.SV". Include the following code in the program.

Each entry line after the command SETVIEWS is a trio that consists of a VIEWS menu text line (a space indicates none), a program name, and a number that defines the view to go to after the program has run its course. All programs listed here will transfer with an aplet when the aplet is transferred.

```
SETVIEWS " "; " "; 18;
```

Sets the first menu option to be "Auto scale". This is the fourth standard Function aplet view menu option and the 18 "Auto scale", specifies that it is to be included in the new menu. The empty quotes will ensure that the old name of "Auto scale" appears on the new menu. See "SETVIEWS" on page 21-14.

```
"My Entry1"; "EXP.ME1"; 1;
```

Sets the second menu option. This option runs program EXP.ME1, then returns to view 1, Plot view.

```
"My Entry2"; "EXP.ME2"; 3;
```

Sets the third menu option. This option runs the program EXP.ME2, then returns to view 3, the NUM view.

```
" "; "EXP.SV"; 0;
```

This line specifies that the program to set the View menu (this program) is transferred with the aplet. The space character between the first set of quotes in the trio specifies that no menu option appears for the entry. You do not need to transfer this program with the aplet, but it allows users to modify the aplet's menu if they want to.

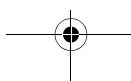
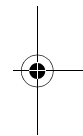
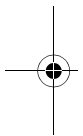



```
""; "EXP.ANG"; 0;
```

The program EXP.ANG is a small routine that is called by other programs that the aplet uses. This entry specifies that the program EXP.ANG is transferred when the aplet is transferred, but the space in the first quotes ensures that no entry appears on the menu.

```
"Start"; "EXP.S"; 7:
```

This specifies the Start menu option. The program that is associated with this entry, EXP.S, runs automatically when you start the aplet. Because this menu option specifies view 7, the VIEWS menu opens when you start the aplet.



You only need to run this program once to configure your aplet's VIEWS menu. Once the aplet's VIEWS menu is configured, it remains that way until you run SETVIEWS again.

You do not need to include this program for your aplet to work, but it is useful to specify that the program is attached to the aplet, and transmitted when the aplet is transmitted.

- Return to the program catalog. The programs that you created should appear as follows:

PROGRAM CATALOG		199KB
EXP.SV	.31KB	
EXP.S	.13KB	
EXP.ANG	.25KB	
EXP.ME2	.21KB	
EXP.ME1	.19KB	

EDIT NEW SEND RECV RUN

- You must now  the program EXP.SV to execute the SETVIEWS command and create the modified VIEWS menu. Check that the name of the new aplet is highlighted in the Aplet view.
- You can now return to the Aplet library and press  to run your new aplet.

## Programming commands

This section describes the commands for programming with HP 40gs. You can enter these commands in your program by typing them or by accessing them from the Commands menu.



## Aplet commands

### CHECK

Checks (selects) the corresponding function in the current aplet. For example, Check 3 would check F3 if the current aplet is Function. Then a checkmark would appear next to F3 in Symbolic view, F3 would be plotted in Plot view, and evaluated in Numeric view.

CHECK *n*:

### SELECT

Selects the named aplet and makes it the current aplet.  
*Note: Quotes are needed if the name contains spaces or other special characters.*

SELECT *apletname*:

### SETVIEWS

The SETVIEWS command is used to define entries in the VIEWS menu for aplets that you customize. See "Customizing an aplet" on page 21-9 for an example of using the SETVIEWS command.

When you use the SETVIEWS command, the aplet's standard VIEWS menu is deleted and the customized menu is used in its place. You only need to apply the command to an aplet once. The VIEWS menu changes remain unless you apply the command again.

Typically, you develop a program that uses the SETVIEWS command only. The command contains a trio of arguments for each menu option to create, or program to attach. Keep the following points in mind when using this command:

- The SETVIEWS command deletes an aplet's standard Views menu options. If you want to use any of the standard options on your reconfigured VIEWS menu, you must include them in the configuration.
- When you invoke the SETVIEWS command, the changes to an aplet's VIEWS menu remain with the aplet. You need to invoke the command on the aplet again to change the VIEWS menu.
- All the programs that are called from the VIEWS menu are transferred when the aplet is transferred, for example to another calculator or to a PC.
- As part of the VIEWS menu configuration, you can specify programs that you want transferred with the aplet, but are not called as menu options. For example, these can be sub-programs that menu

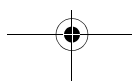
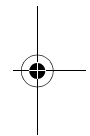
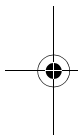



options use, or the program that defines the aplet's VIEWS menu.

- You can include a "Start" option in the VIEWS menu to specify a program that you want to run automatically when the aplet starts. This program typically sets up the aplet's initial configuration. The START option on the menu is also useful for resetting the aplet.

### Command syntax

The syntax for the command is as follows:

```

SETVIEWS
"Prompt1"; "ProgramName1"; ViewNumber1;
"Prompt2"; "ProgramName2"; ViewNumber2;
(You can repeat as many Prompt/ProgramName/
ViewNumber trios of arguments as you like.)

```

Within each *Prompt/ProgramName/ViewNumber* trio, you separate each item with a semi-colon.

### Prompt

*Prompt* is the text that is displayed for the corresponding entry in the Views menu. Enclose the prompt text in double quotes.

### Associating programs with your aplet

If *Prompt* consists of a single space, then no entry appears in the view menu. The program specified in the *ProgramName* item is associated with the aplet and transferred whenever the aplet is transmitted. Typically, you do this if you want to transfer the Setviews program with the aplet, or you want to transfer a sub-program that other menu programs use.

### Auto-run programs

If the *Prompt* item is "Start", then the *ProgramName* program runs whenever you start the aplet. This is useful for setting up a program to configure the aplet. Users can select the Start item from the VIEWS menu to reset the aplet if they change configurations.

You can also define a menu item called "Reset" which is auto-run if the user chooses the  button in the APLET view.

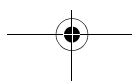
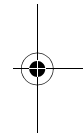
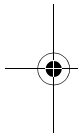



### ***ProgramName***

*ProgramName* is the name of the program that runs when the corresponding menu entry is selected. All programs that are identified in the aplet's SETVIEWS command are transferred when the aplet is transmitted.

### ***ViewNumber***

*ViewNumber* is the number of a view to start after the program finishes running. For example, if you want the menu option to display the Plot view when the associated program finishes, you would specify 1 as the *ViewNumber* value.

### ***Including standard menu options***

To include one of an aplet's standard VIEWS menu options in your customized menu, set up the arguments trio as follows:

- The first argument specifies the menu item name:
  - Leave the argument empty to use the standard Views menu name for the item, or
  - Enter a menu item name to replace the standard name.
- The second argument specifies the program to run:
  - Leave the argument empty to run the standard menu option.
  - Insert a program name to run the program before the standard menu option is executed.
- The third argument specifies the view and the menu number for the item. Determine the menu number from the View numbers table below.

*Note: SETVIEWS with no arguments resets the views to default of the base aplet.*

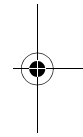
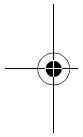



### **View numbers**

The Function applet views are numbered as follows:

0	HOME	11	List Catalog
1	Plot	12	Matrix Catalog
2	Symbolic	13	Notepad Catalog
3	Numeric	14	Program Catalog
4	Plot-Setup	15	Plot-Detail
5	Symbolic-Setup	16	Plot-Table
6	Numeric-Setup	17	Overlay Plot
7	Views	18	Auto scale
8	Note	19	Decimal
9	Sketch view	20	Integer
10	Applet Catalog	21	Trig

View numbers from 15 on will vary according to the parent applet. The list shown above is for the Function applet. Whatever the normal VIEWS menu for the parent applet, the first entry will become number 15, the second number 16 and so on.

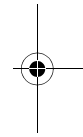
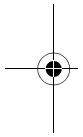

### **UNCHECK**

Unchecks (unselects) the corresponding function in the current applet. For example, Uncheck 3 would uncheck F3 if the current applet is Function.

UNCHECK *n*:

## **Branch commands**

*Branch commands* let a program make a decision based on the result of one or more tests. Unlike the other programming commands, the branch commands work in logical groups. Therefore, the commands are described together rather than each independently.

### **IF...THEN...END**

Executes a sequence of commands in the *true-clause* only if the *test-clause* evaluates to true. Its syntax is:

IF *test-clause*

THEN *true-clause* END

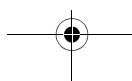

**Example**

```

1▶A :
IF A==1
  THEN MSGBOX " A EQUALS 1" :
END:

```

**IF... THEN... ELSE...  
END**

Executes the *true-clause* sequence of commands if the *test-clause* is true, or the *false-clause* sequence of commands if the *test-clause* is false.

```

IF test-clause
THEN true-clause ELSE false-clause END

```

**Example**

```

1▶A :
IF A==1 THEN
  MSGBOX "A EQUALS 1" :
ELSE
  MSGBOX "A IS NOT EQUAL TO 1" :
A+1▶A :
END:

```

**CASE...END**

Executes a series of test-clause commands that execute the appropriate *true-clause* sequence of commands. Its syntax is:

```

CASE
IF test-clause1 THEN true-clause1 END
IF test-clause2 THEN true-clause2 END
.
.
.
IF test-clausen THEN true-clausen END
END:

```

When CASE is executed, *test-clause*<sub>1</sub> is evaluated. If the test is true, *true-clause*<sub>1</sub> is executed, and execution skips to END. If *test-clause*<sub>1</sub> is false, execution proceeds to *test-clause*<sub>2</sub>. Execution with the CASE structure continues until a true-clause is executed (or until all the test-clauses evaluate to false).

**IFERR...  
THEN...  
ELSE...  
END...**

Many conditions are automatically recognized by the HP 40gs as *error conditions* and are automatically treated as errors in programs.

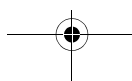



IFERR...THEN...ELSE...END allows a program to intercept error conditions that otherwise would cause the program to abort. Its syntax is:

```
IFERR trap-clause
THEN clause_1
ELSE clause_2
END :
```

### Example

```
IFERR
  60/X ► Y:
THEN
  MSGBOX "Error: X is zero.":
ELSE
  MSGBOX "Value is "Y:
END:
```

### RUN

Runs the named program. If your program name contains special characters, such as a space, then you must enclose the file name in double quotes (" ").

```
RUN "program name" : or RUN programname :
```

### STOP

Stops the current program.

```
STOP :
```

## Drawing commands

The drawing commands act on the display. The scale of the display depends on the current aplet's Xmin, Xmax, Ymin, and Ymax values. *The following examples assume the HP 40gs default settings with the Function aplet as the current aplet.*

### ARC

Draws a circular arc, of given radius, whose centre is at (x,y) The arc is drawn from *start\_angle\_measurement* to *end\_angle\_measurement*.

```
ARC x;y;radius;start_angle_measurement;  
end_angle_measurement:
```

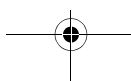
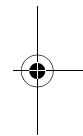
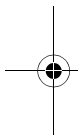

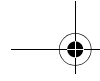

**Example**

ARC 0;0;2;0;2π:  
FREEZE:  
Draws a circle centered at (0,0) of radius 2. The FREEZE command causes the circle to remain displayed on the screen until you press a key.

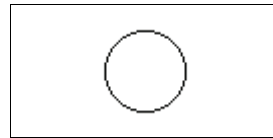

**BOX**

Draws a box with diagonally opposite corners (x1,y1) and (x2,y2).

BOX x1;y1;x2;y2:

**Example**

BOX -1;-1;1;1:  
FREEZE:  
Draws a box, lower corner at (-1,-1), upper corner at (1,1)

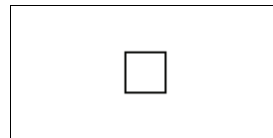

**ERASE**

Clears the display

ERASE:

**FREEZE**

Halts the program, freezing the current display. Execution resumes when any key is pressed.

**LINE**

Draws a line from (x1, y1) to (x2, y2).

LINE x1;y1;x2;y2:

**PIXOFF**

Turns off the pixel at the specified coordinates (x,y).

PIXOFF x;y:

**PIXON**

Turns on the pixel at the specified coordinates (x,y).

PIXON x;y:

**TLINE**

Toggles the pixels along the line from (x1, y1) to (x2, y2) on and off. Any pixel that was turned off, is turned on; any pixel that was turned on, is turned off. TLINE can be used to erase a line.

TLINE x1;y1;x2;y2:

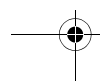
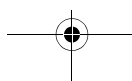





### Example

```
TLINE 0;0;3;3:
```

Erases previously drawn 45 degree line from (0,0) to (3,3), or draws that line if it doesn't already exist.

## Graphic commands

The graphic commands use the graphics variables G0 through G9—or the Page variable from Sketch—as *graphicname* arguments. The *position* argument takes the form (*x*, *y*). Position coordinates depend on the current aplet's scale, which is specified by Xmin, Xmax, Ymin, and Ymax. The upper left corner of the target graphic (*graphic2*) is at (Xmin,Ymax).

You can capture the current display and store it in G0 by simultaneously pressing **ON** + **PLOT**.

### DISPLAY→

Stores the current display in *graphicname*.

```
DISPLAY→ graphicname:
```

### →DISPLAY

Displays graphic from *graphicname* in the display.

```
→DISPLAY graphicname:
```

### →GROB

Creates a graphic from *expression*, using *font\_size*, and stores the resulting graphic in *graphicname*. Font sizes are 1, 2, or 3. If the *fontsize* argument is 0, the HP 40gs creates a graphic display like that created by the SHOW operation.

```
→GROB graphicname; expression; fontsize :
```

### GROBNOT

Replaces graphic in *graphicname* with bitwise-inverted graphic.

```
GROBNOT graphicname :
```

### GROBOR

Using the logical OR, superimposes *graphicname2* onto *graphicname1*. The upper left corner of *graphicname2* is placed at *position*.

```
GROBOR graphicname1; (position); graphicname2 :
```

where *position* is expressed in terms of the current axes settings, not in terms of pixel position.

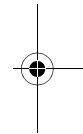
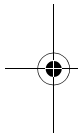



**GROBXOR**

Using the logical XOR, superimposes *graphicname2* onto *graphicname1*. The upper left corner of *graphicname2* is placed at *position*.

GROBXOR  
*graphicname1* ; (*position*) ; *graphicname2* :

**MAKEGROB**

Creates graphic with given width, height, and hexadecimal data, and stores it in *graphicname*.

MAKEGROB *graphicname* ; *width* ; *height* ; *hexdata* :

**PLOT→**

Stores the Plot view display as a graphic in *graphicname*.

PLOT→ *graphicname* :

PLOT→ and DISPLAY→ can be used to transfer a copy of the current PLOT view into the sketch view of the aplet for later use and editing.

**Example**

1 ►PageNum:  
PLOT→ Page:  
→DISPLAY Page:  
FREEZE:

This program stores the current PLOT view to the first page in the sketch view of the current aplet and then displays the sketch as a graphic object until any key is pressed.

**→PLOT**

Puts graph from *graphicname* into the Plot view display.

→PLOT *graphicname* :

**REPLACE**

Replaces portion of graphic in *graphicname1* with *graphicname2*, starting at *position*. REPLACE also works for lists and matrices.

REPLACE  
*graphicname1* ; (*position*) ; *graphicname2* :

**SUB**

Extracts a portion of the named graphic (or list or matrix), and stores it in a new variable, *name*. The portion is specified by *position* and *positions*.

SUB *name* ; *graphicname* ; (*position*) ; (*positions*) :

**ZEROGROB**

Creates a blank graphic with given *width* and *height*, and stores it in *graphicname*.

ZEROGROB *graphicname* ; *width* ; *height* :

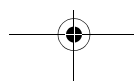



## Loop commands

Loop hp allow a program to execute a routine repeatedly. The HP 40gs has three loop structures. The example programs below illustrate each of these structures incrementing the variable A from 1 to 12.

### DO...UNTIL ...END

Do ... Until ... End is a loop command that executes the *loop-clause* repeatedly until *test-clause* returns a true (nonzero) result. Because the test is executed *after* the loop-clause, the loop-clause is always executed at least once. Its syntax is:

```
DO loop-clause UNTIL test-clause END

1 ▶ A:
DO
  A + 1 ▶ A:
  DISP 3;A:
UNTIL A == 12 END:
```

### WHILE... REPEAT... END

While ... Repeat ... End is a loop command that repeatedly evaluates *test-clause* and executes *loop-clause* sequence if the test is true. Because the test-clause is executed before the loop-clause, the loop-clause is not executed if the test is initially false. Its syntax is:

```
WHILE test-clause REPEAT loop-clause END

1 ▶ A:
WHILE A < 12 REPEAT
  A+1 ▶ A:
  DISP 3;A:
END:
```

### FOR...TO...STEP ...END

```
FOR name=start-expression TO end-expression
  [STEP increment]; loop-clause END

FOR A=1 TO 12 STEP 1;
  DISP 3;A:
END:
```

Note that the STEP parameter is optional. If it is omitted, a step value of 1 is assumed.

### BREAK

Terminates loop.

```
BREAK:
```

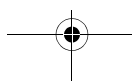
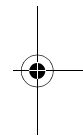
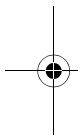



## Matrix commands

The matrix commands take variables M0–M9 as arguments.

### ADDCOL

Add Column. Inserts *values* into a column before *column\_number* in the specified matrix. You enter the *values* as a vector. The values must be separated by commas and the number of values must be the same as the number of rows in the matrix *name*.

ADDCOL  
*name*; [*value*<sub>1</sub>,...,*value*<sub>*n*</sub>]; *column\_number* :

### ADDFROW

Add Row. Inserts *values* into a row before *row\_number* in the specified matrix. You enter the values as a vector. The values must be separated by commas and the number of values must be the same as the number of columns in the matrix *name*.

ADDFROW *name*; [*value*<sub>1</sub>,..., *value*<sub>*n*</sub>]; *row\_number* :

### DELCOL

Delete Column. Deletes the specified column from the specified matrix.

DELCOL *name*; *column\_number* :

### DELFROW

Delete Row. Deletes the specified row from the specified matrix.

DELFROW *name*; *row\_number* :

### EDITMAT

Starts the Matrix Editor and displays the specified matrix. If used in programming, returns to the program when user presses .

EDITMAT *name* :

### RANDMAT

Creates random matrix with a specified number of rows and columns and stores the result in *name* (*name* must be M0 . . . M9). The entries will be integers ranging from -9 to 9.

RANDMAT *name*; *rows*; *columns* :

### REDIM

Redimensions the specified matrix or vector to *size*. For a matrix, *size* is a list of two integers  $\{n1,n2\}$ . For a vector, *size* is a list containing one integer  $\{n\}$ .

REDIM *name*; *size* :

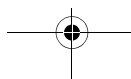
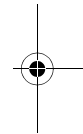
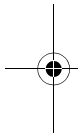

**REPLACE**

Replaces portion of a matrix or vector stored in *name* with an object starting at position *start*. *start* for a matrix is a list containing two numbers; for a vector, it is a single number. Replace also works with lists and graphics.

REPLACE *name ; start ; object :*

**SCALE**

Multiplies the specified *row\_number* of the specified matrix by *value*.

SCALE *name ; value ; rownumber :*

**SCALEADD**

Multiplies the row of the matrix *name* by *value*, then adds this result to the second specified row.

SCALEADD *name ; value ; row1 ; row2 :*

**SUB**

Extracts a *sub-object*—a portion of a list, matrix, or graphic from *object*—and stores it into *name*. *start* and *end* are each specified using a list with two numbers for a matrix, a number for vector or lists, or an ordered pair, (X, Y), for graphics.

SUB *name ; object ; start ; end :*

**SWAPCOL**

Swaps Columns. Exchanges *column1* and *column2* of the specified matrix.

SWAPCOL *name ; column1 ; column2 :*

**SWAPROW**

Swap Rows. Exchanges *row1* and *row2* in the specified matrix.

SWAPROW *name ; row1 ; row2 :*

**Print commands**

These commands print to an HP infrared printer, for example the HP 82240B printer.

**PRDISPLAY**

Prints the contents of the display.

PRDISPLAY :

**PRHISTORY**

Prints all objects in the history.

PRHISTORY :

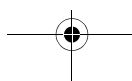
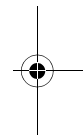
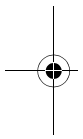



## PRVAR

Prints name and contents of *variablename*.

`PRVAR variablename :`

You can also use the PRVAR command to print the contents of a program or a note.

`PRVAR programname ; PROG :`

`PRVAR notename ; NOTE :`

## Prompt commands

### BEEP

Beeps at the frequency and for the time you specify.

`BEEP frequency ; seconds :`

### CHOOSE

Creates a choose box, which is a box containing a list of options from which the user chooses one. Each option is numbered, 1 through *n*. The result of the choose command is to store the number of the option chosen in a variable. The syntax is:

`CHOOSE variable_name ; title ; option1 ; option2 ;  
...optionn :`

where *variable\_name* is the name of a variable for storing a default option number, *title* is the text displayed in the title bar of the choose box, and *option*<sub>1</sub>...*option*<sub>*n*</sub> are the options listed in the choose box.

By pre-storing a value into *variable\_name* you can specify the default option number, as shown in the example below.

#### Example

```
3 ► A:CHOOSE A;  
"COMIC STRIPS";  
"DILBERT";  
"CALVIN&HOBBES";  
"BLONDIE";
```



### CLRVAR

Clears the specified variable. The syntax is:

`CLRVAR variable :`

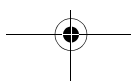

### Example

If you have stored {1,2,3,4} in variable L1, entering CLRVAR L1  will clear L1.

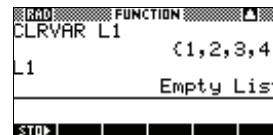

### DISP

Displays *textitem* in a row of the display at the *line\_number*. A text item consists of any number of expressions and quoted strings of text. The expressions are evaluated and turned into strings. Lines are numbered from the top of the screen, 1 being the top and 7 being the bottom.

`DISP line_number; textitem :`

### Example

`DISP 3;"A is" 2+2`  
 Result: A is 4  
 (displayed on line 3)



### DISPXY

Displays *object* at position (*x\_pos*, *y\_pos*) in size *font*. The syntax is:

`DISPXY x_pos; y_pos; font; object:`

The value of *object* can be a text string, a variable, or a combination of both. *x\_pos* and *y\_pos* are relative to the current settings of Xmin, Xmax, Ymin and Ymax (which you set in the PLOT SETUP view). The value of *font* is either 1 (small) or 2 (large).

### Example

`DISPXY`  
`-3.5; 1.5; 2; "HELLO`  
`WORLD":`

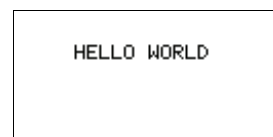

### DISPTIME

Displays the current date and time.

`DISPTIME`

To set the date and time, simply store the correct settings in the date and time variables. Use the following formats: M.DDYYYY for the date and H.MMSS for the time.

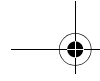

### Examples

5.152000 ► DATE (sets the date to May 15, 2000).

10.1500 ► TIME (sets the time to 10:15 am).

### EDITMAT

Matrix Editor. Opens the Matrix editor for the specified matrix. Returns to the program when user presses

EDITMAT *matrixname* :

The EDITMAT command can also be used to create matrices.

1. Press *CMD5*
2. Press *M 1*, and then press .

The Matrix catalog opens with M1 available for editing.

EDITMAT *matrixname* is an alternative to opening the matrix editor with *matrixname*. It can be used in a program to enter a matrix.

### FREEZE

This command prevents the display from being updated after the program runs. This allows you to view the graphics created by the program. Cancel FREEZE by pressing any key.

FREEZE :

### GETKEY

Waits for a key, then stores the keycode *rc.p* in *name*, where *r* is row number, *c* is column number, and *p* is key-plane number. The key-planes numbers are: 1 for unshifted; 2 for shifted; 4 for alpha-shifted; and 5 for both alpha-shifted and shifted.

GETKEY *name* :

### INPUT

Creates an input form with a title bar and one field. The field has a label and a default value. There is text help at the bottom of the form. The user enters a value and presses the menu key. The value that the user enters is stored in the variable *name*. The *title*, *label*, and *help* items are text strings and need to be enclosed in double quotes.

Use *CHARS* to type the quote marks " " .

INPUT *name* ; *title* , *label* ; *help* ; *default* :

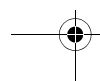
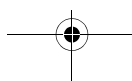
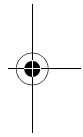
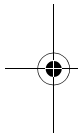



**Example**

```
INPUT R; "Circular Area";
      "Radius";
      "Enter Number";1:
```

**MSGBOX**

Displays a message box containing *textitem*. A text item consists of any number of expressions and quoted strings of text. The expressions are evaluated and turned into strings of text.

For example, "AREA IS: " 2 + 2 becomes AREA IS: 4. Use **[SHIFT]** *CHARS* to type the quote marks " ".

MSGBOX *textitem* :

**Example**

```
1 ► A:
MSGBOX "AREA IS: "π*A^2:
```

You can also use the NoteText variable to provide text arguments. This can be used to insert line breaks. For example, press **[SHIFT]** *NOTE* and type AREA IS **[ENTER]**.

The position line

```
MSGBOX NoteText " " π*A^2:
```

will display the same message box as the previous example.

**PROMPT**

Displays an input box with *name* as the title, and prompts for a value for *name*. *name* can be a variable such as A...Z, θ, L1...L9, C1...C9 or Z1...Z9..

PROMPT *name* :

**WAIT**

Halts program execution for the specified number of seconds.

WAIT *seconds* :

**Stat-One and Stat-Two commands**

The following commands are used for analyzing one-variable and two-variable statistical data.

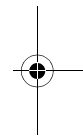
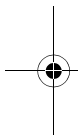



## Stat-One commands

### DO1VSTATS

Calculates STATS using *datasetname* and stores the results in the corresponding variables:  $N\Sigma$ ,  $Tot\Sigma$ ,  $Mean\Sigma$ ,  $PVar\Sigma$ ,  $SVar\Sigma$ ,  $PSDev$ ,  $SSDev$ ,  $Min\Sigma$ ,  $Q1$ ,  $Median$ ,  $Q3$ , and  $Max\Sigma$ . *Datasetname* can be H1, H2, ..., or H5. *Datasetname* must include at least two data points.

DO1VSTATS *datasetname* :

### SETFREQ

Sets *datasetname* frequency according to *column* or *value*. *Datasetname* can be H1, H2, ..., or H5, *column* can be C0–C9 and *value* can be any positive integer.

SETFREQ *datasetname* ; *column* :

or

SETFREQ *definition* ; *value* :

### SETSAMPLE

Sets *datasetname* sample according to *column*. *Datasetname* can be H1–H5, and *column* can be C0–C9.

SETSAMPLE *datasetname* ; *column* :

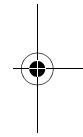
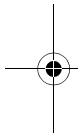

## Stat-Two commands

### DO2VSTATS

Calculates STATS using *datasetname* and stores the results in corresponding variables:  $MeanX$ ,  $\Sigma X$ ,  $\Sigma X^2$ ,  $MeanY$ ,  $\Sigma Y$ ,  $\Sigma Y^2$ ,  $\Sigma XY$ ,  $Corr$ ,  $PCov$ ,  $SCov$ , and  $RELERR$ . *Datasetname* can be S1, S2, ..., or S5. *Datasetname* must include at least two pairs of data points.

DO2VSTATS *datasetname* :

### SETDEPEND

Sets *datasetname* dependent *column*. *Datasetname* can be S1, S2, ..., or S5 and *column* can be C0–C9.

SETDEPEND *datasetname* ; *column* :

### SETINDEP

Sets *datasetname* independent *column*. *Datasetname* can be S1, S2, ..., or S5 and *column* can be C0–C9.

SETINDEP *datasetname* ; *column* :

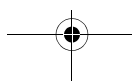



## Storing and retrieving variables in programs

The HP 40gs has both Home variables and Aplet variables. Home variables are used for real numbers, complex numbers, graphics, lists, and matrices. Home variables keep the same values in HOME and in aplets.

Aplet variables are those whose values depend on the current aplet. The aplet variables are used in programming to emulate the definitions and settings you make when working with aplets interactively.

You use the Variable menu (**VARS**) to retrieve either Home variables or aplet variables. See "The VARS menu" on page 17-4. Not all variables are available in every aplet. S1fit–S5fit, for example, are only available in the Statistics aplet. Under each variable name is a list of the aplets where the variable can be used.

## Plot-view variables

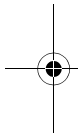

**Area**  
*Function*

Contains the last value found by the Area function in Plot-FCN menu.

**Axes**  
*All Aplets*

Turns axes on or off.

From Plot Setup, check (or uncheck) `__AXES`.

or

In a program, type:

- 1 ► `Axes`—to turn axes on (default).
- 0 ► `Axes`—to turn axes off.

*Connect*  
*Function*  
*Parametric*  
*Polar*  
*Solve*  
*Statistics*

Draws lines between successively plotted points.

From Plot Setup, check (or uncheck) `__CONNECT`.

or

In a program, type

- 1 ► `Connect`—to connect plotted points (default, except in Statistics where the default is off).
- 0 ► `Connect`—not to connect plotted points.

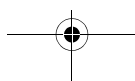
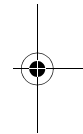



### Coord

*Function*  
*Parametric*  
*Polar*  
*Sequence*  
*Solve*  
*Statistics*

Turns the coordinate-display mode in Plot view on or off.

From Plot view, use the Menu mean key to toggle coordinate display on an off.

In a program, type

- 1 ► `Coord`—to turn coordinate display on (default).
- 0 ► `Coord`—to turn coordinate display off.

### Extremum

*Function*

Contains the last value found by the Extremum operation in the Plot-FCN menu.

### FastRes

*Function*  
*Solve*

Toggles resolution between plotting in every other column (faster), or plotting in every column (more detail).

From Plot Setup, choose Faster or More Detail.

or

In a program, type

- 1 ► `FastRes`—for faster.
- 0 ► `FastRes`—for more detail (default).

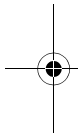

### Grid

*All Aplets*

Turns the background grid in Plot view on or off. From Plot setup, check (or uncheck) `__GRID`.

or

In a program, type

- 1 ► `Grid` to turn the grid on.
- 0 ► `Grid` to turn the grid off (default).

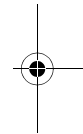

### Hmin/Hmax

*Statistics*

Defines minimum and maximum values for histogram bars.

From Plot Setup for one-variable statistics, set values for HRNG.

or

In a program, type

- $n_1$  ► `Hmin`
- $n_2$  ► `Hmax`
- where  $n_2 > n_1$

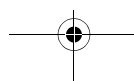

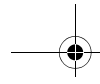

**Hwidth**  
*Statistics*

Sets the width of histogram bars.

From Plot Setup in TVAR stats set a value for `Hwidth`  
or

In a program, type

`n ▶ Hwidth`

**Indep**  
*All Aplets*

Defines the value of the independent variable used in tracing mode.

In a program, type

`n ▶ Indep`

**InvCross**  
*All Aplets*

Toggles between solid crosshairs or inverted crosshairs. (Inverted is useful if the background is solid).

From Plot Setup, check (or uncheck) `__InvCross`

or

In a program, type:

`1 ▶ InvCross`—to invert the crosshairs.

`0 ▶ InvCross` —for solid crosshairs (default).

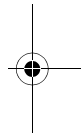
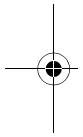

**Isect**  
*Function*

Contains the last value found by the Intersection function in the Plot-FCN menu.

**Labels**  
*All Aplets*

Draws labels in Plot view showing X and Y ranges.

From Plot Setup, check (or uncheck) `__Labels`

or

In a program, type

`1 ▶ Labels`—to turn labels on.

`0 ▶ Labels`—to turn labels off (default).

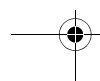
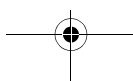

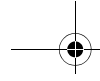

**Nmin / Nmax**  
*Sequence*

Defines the minimum and maximum independent variable values. Appears as the NRNG fields in the Plot Setup input form.

From Plot Setup, enter values for NRNG.

or

In a program, type

$n_1$  ► Nmin

$n_2$  ► Nmax

where  $n_2 > n_1$

**Recenter**  
*All Aplets*

Recenters at the crosshairs locations when zooming.

From Plot-Zoom-Set Factors, check (or uncheck)  Recenter

or

In a program, type

1 ► Recenter— to turn recenter on (default).

0 ► Recenter—to turn recenter off.

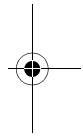
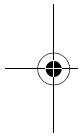

**Root**  
*Function*

Contains the last value found by the Root function in the Plot-FCN menu.

**S1mark–S5mark**  
*Statistics*

Sets the mark to use for scatter plots.

From Plot Setup for two-variable statistics, S1mark–S5mark, then choose a mark.

or

In a program, type

n ► S1mark

where n is 1, 2, 3, . . . 5

**SeqPlot**  
*Sequence*

Enables you to choose types of sequence plot: Stairstep or Cobweb.

From Plot Setup, select SeqPlot, then choose Stairstep or Cobweb.

or

In a program, type

1 ► SeqPlot—for Stairstep.

2 ► SeqPlot—for Cobweb.

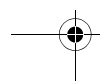
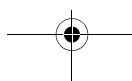



**Simult**

*Function*  
*Parametric*  
*Polar*  
*Sequence*

Enables you to choose between simultaneous and sequential graphing of all selected expressions.

From Plot Setup, check (or uncheck) `_SIMULT`

or  
In a program, type

- 1 ► `Simult`—for simultaneous graphing (default).
- 0 ► `Simult`—for sequential graphing.

**Slope**

*Function*

Contains the last value found by the Slope function in the Plot-FCN menu.

**StatPlot**

*Statistics*

Enables you to choose types of 1-variable statistics plot between Histogram or Box-and-Whisker.

From Plot Setup, select `StatPlot`, then choose Histogram or `BoxWhisker`.

or  
In a program, type

- 1 ► `StatPlot`—for Histogram.
- 2 ► `StatPlot`—for Box-and-Whisker.

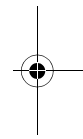
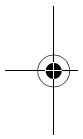

**Umin/Umax**

*Polar*

Sets the minimum and maximum independent values. Appears as the `URNG` field in the Plot Setup input form.

From the Plot Setup input form, enter values for `URNG`.

or  
In a program, type

- $n_1$  ► `Umin`
- $n_2$  ► `Umax`

where  $n_2 > n_1$

**Ustep**

*Polar*

Sets the step size for an independent variable.

From the Plot Setup input form, enter values for `USTEP`.

or  
In a program, type

- $n$  ► `Ustep`
- where  $n > 0$

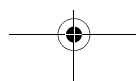

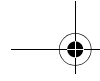

### **Tmin / Tmax**

*Parametric*

Sets the minimum and maximum independent variable values. Appears as the `TRNG` field in the Plot Setup input form.

From Plot Setup, enter values for `TRNG`.

or

In a program, type

`n1 ► Tmin`

`n2 ► Tmax`

where  $n_2 > n_1$

### **Tracing**

*All Aplets*

Turns the tracing mode on or off in Plot view.

In a program, type

`1 ► Tracing`—to turn Tracing mode on (default).

`0 ► Tracing`—to turn Tracing mode off.

### **Tstep**

*Parametric*

Sets the step size for the independent variable.

From the Plot Setup input form, enter values for `TSTEP`.

or

In a program, type

`n ► Tstep`

where  $n > 0$

### **Xcross**

*All Aplets*

Sets the horizontal coordinate of the crosshairs. Only works with `TRACE` off.

In a program, type

`n ► Xcross`

### **Ycross**

*All Aplets*

Sets the vertical coordinate of the crosshairs. Only works with `TRACE` off.

In a program, type

`n ► Ycross`

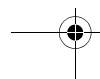
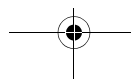
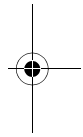
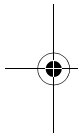





**Xtick**  
*All Aplets*

Sets the distance between tick marks for the horizontal axis.

From the Plot Setup input form, enter a value for Xtick.

or

In a program, type

$n \blacktriangleright$  Xtick where  $n > 0$

**Ytick**  
*All Aplets*

Sets the distance between tick marks for the vertical axis.

From the Plot Setup input form, enter a value for Ytick.

or

In a program, type

$n \blacktriangleright$  Ytick where  $n > 0$

**Xmin / Xmax**  
*All Aplets*

Sets the minimum and maximum horizontal values of the plot screen. Appears as the XRNG fields (horizontal range) in the Plot Setup input form.

From Plot Setup, enter values for XRNG.

or

In a program, type

$n_1 \blacktriangleright$  Xmin

$n_2 \blacktriangleright$  Xmax

where  $n_2 > n_1$

**Ymin / Ymax**  
*All Aplets*

Sets the minimum and maximum vertical values of the plot screen. Appears as the YRNG fields (vertical range) in the Plot Setup input form.

From Plot Setup, enter the values for YRNG.

or

In a program, type

$n_1 \blacktriangleright$  Ymin

$n_2 \blacktriangleright$  Ymax

where  $n_2 > n_1$

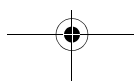
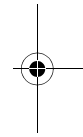
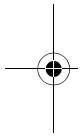



### **Xzoom**

*All Aplets*

Sets the horizontal zoom factor.

From Plot-ZOOM-Set Factors, enter the value for XZOOM.

or

In a program, type

$n \blacktriangleright$  XZOOM

where  $n > 0$

The default value is 4.

### **Yzoom**

*All Aplets*

Sets the vertical zoom factor.

From Plot-ZOOM-Set Factors, enter the value for YZOOM.

or

In a program, type

$n \blacktriangleright$  YZOOM

The default value is 4.

## **Symbolic-view variables**

### **Angle**

*All Aplets*

Sets the angle mode.

From Symbolic Setup, choose Degrees, Radians, or Grads for angle measure.

or

In a program, type

1  $\blacktriangleright$  Angle —for Degrees.

2  $\blacktriangleright$  Angle —for Radians.

3  $\blacktriangleright$  Angle—for Grads.

### **F1...F9, F0**

*Function*

Can contain any expression. Independent variable is X.

#### **Example**

'SIN(X)'  $\blacktriangleright$  F1(X)

You must put single quotes around an expression to keep it from being evaluated before it is stored. Use

**[SHIFT]** CHARS to type the single quote mark.

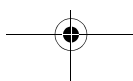
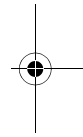
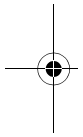



**X1, Y1...X9, Y9**  
**X0, Y0**

*Parametric*

Can contain any expression. Independent variable is T.

**Example**

'SIN(4\*T)' ► Y1(T) : '2\*SIN(6\*T)' ►  
X1(T)

**R1...R9, R0**

*Polar*

Can contain any expression. Independent variable is  $\theta$ .

**Example**

'2\*SIN(2\*\theta)' ► R1( $\theta$ )

**U1...U9, U0**

*Sequence*

Can contain any expression. Independent variable is N.

**Example**

RECURSE (U, U(N-1)\*N, 1, 2) ► U1(N)

**E1...E9, E0**

*Solve*

Can contain any equation or expression. Independent variable is selected by highlighting it in Numeric View.

**Example**

'X+Y\*X-2=Y' ► E1

**S1fit...S5fit**

*Statistics*

Sets the type of fit to be used by the FIT operation in drawing the regression line.

From Symbolic Setup view, specify the fit in the field for S1FIT, S2FIT, etc.

or

In a program, store one of the following constant numbers or names into a variable S1fit, S2fit, etc.

- 1 Linear
- 2 LogFit
- 3 ExpFit
- 4 Power
- 5 QuadFit
- 6 Cubic
- 7 Logist
- 8 ExptFit
- 9 TrigFit
- 10 User

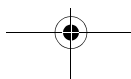
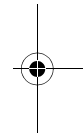
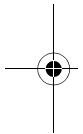



### Example

Cubic ► S2fit

or

6 ► S2fit

## Numeric-view variables

The following aplet variables control the Numeric view. The value of the variable applies to the current aplet only.

### **C1...C9, C0** *Statistics*

C0 through C9, for columns of data. Can contain lists.

Enter data in the Numeric view

or

In a program, type

LIST ► Cn

where  $n = 0, 1, 2, 3 \dots 9$

### **Digits** *All Aplets*

Number of decimal places to use for Number format in the HOME view and for labeling axes in the Plot view.

From the Modes view, enter a value in the second field of Number Format.

or

In a program, type

n ► Digits

where  $0 < n < 11$

### **Format** *All Aplets*

Defines the number display format to use for numeric format on the HOME view and for labeling axes in the Plot view.

From the Modes view, choose Standard, Fixed, Scientific, Engineering, Fraction or Mixed Fraction in the Number Format field.

or

In a program, store the constant number (or its name) into the variable Format.

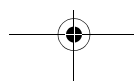
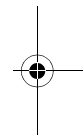
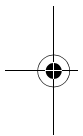



- 1 Standard
- 2 Fixed
- 3 Sci
- 4 Eng
- 5 Fraction
- 6 MixFraction

**Note:** if Fraction or Mixed Fraction is chosen, the setting will be disregarded when labeling axes in the Plot view. A setting of Scientific will be used instead.

**Example**

Scientific ► Format

or

3 ► Format

**NumCol**

*All Aplets except  
Statistics aplet*

Sets the column to be highlighted in Numeric view.

In a program, type

*n* ► NumCol

where *n* can be 0, 1, 2, 3, 4, 5, 6, 7, 8, 9.

**NumFont**

*Function  
Parametric  
Polar  
Sequence  
Statistics*

Enables you to choose the font size in Numeric view. Does not appear in the Num Setup input form. Corresponds to the **315** key in Numeric view.

In a program, type

0 ► NumFont for small (default).

1 ► NumFont for big.

**NumIndep**

*Function  
Parametric  
Polar  
Sequence*

Specifies the list of independent values to be used by Build Your Own Table.

In a program, type

LIST ► NumIndep

**NumRow**

*All Aplets except  
Statistics aplet*

Sets the row to be highlighted in Numeric view.

In a program, type

*n* ► NumRow

where *n* > 0

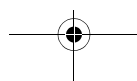



**NumStart**

*Function*  
*Parametric*  
*Polar*  
*Sequence*

Sets the starting value for a table in Numeric view.

From Num Setup, enter a value for NUMSTART.

or

In a program, type

$n \blacktriangleright$  NumStart

**NumStep**

*Function*  
*Parametric*  
*Polar*  
*Sequence*

Sets the step size (increment value) for an independent variable in Numeric view.

From Num Setup, enter a value for NUMSTEP.

or

In a program, type

$n \blacktriangleright$  NumStep

where  $n > 0$

**NumType**

*Function*  
*Parametric*  
*Polar*  
*Sequence*

Sets the table format.

From Num Setup, choose Automatic or Build Your Own.

or

In a program, type

0  $\blacktriangleright$  NumType for Build Your Own.

1  $\blacktriangleright$  NumType for Automatic (default).

**NumZoom**

*Function*  
*Parametric*  
*Polar*  
*Sequence*

Sets the zoom factor in the Numeric view.

From Num Setup, type in a value for NUMZOOM.

or

In a program, type

$n \blacktriangleright$  NumZoom

where  $n > 0$

**StatMode**

*Statistics*

Enables you to choose between 1-variable and 2-variable statistics in the Statistics aplet. Does not appear in the Plot Setup input form. Corresponds to the **1VAR** and **2VAR** menu keys in Numeric View.

In a program, store the constant name (or its number) into the variable StatMode. 1VAR=1, 2VAR=2.

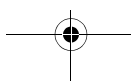
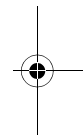
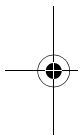



### Example

1VAR ► StatMode

or

1 ► StatMode

## Note variables

The following aplet variable is available in Note view.

### NoteText

All Aplets

Use `NoteText` to recall text previously entered in Note view.

## Sketch variables

The following aplet variables are available in Sketch view.

### Page

All Aplets

Sets a *page* in a sketch set. The graphics can be viewed one at a time using the `◀` and `▶` keys.

The Page variable refers to the currently displayed page of a sketch set.

In a program, type

`graphicname ► Page`

### PageNum

All Aplets

Sets a number for referring to a particular page of the sketch set (in Sketch view).

In a program, type the page that is shown when `◀` `SKETCH` is pressed.

`n ► PageNum`

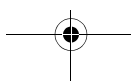
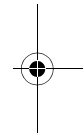
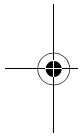

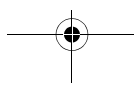
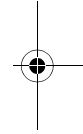
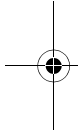
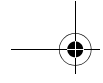





## 22

### Extending aplets

---

Aplets are the application environments where you explore different classes of mathematical operations.

You can extend the capability of the HP 40gs in the following ways:

- Create new aplets, based on existing aplets, with specific configurations such as angle measure, graphical or tabular settings, and annotations.
- Transmit aplets between HP 40gs calculators via a serial or USB cable.
- Download e-lessons (teaching aplets) from Hewlett-Packard's Calculator web site.
- Program new aplets. See chapter 21, "Programming", for further details.

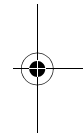
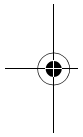

### Creating new aplets based on existing aplets

You can create a new aplet based on an existing aplet. To create a new aplet, save an existing aplet under a new name, then modify the aplet to add the configurations and the functionality that you want.

Information that defines an aplet is saved automatically as it is entered into the calculator.

To keep as much memory available for storage as possible, delete any aplets you no longer need.

#### Example

This example demonstrates how to create a new aplet by saving a copy of the built-in Solve aplet. The new aplet is saved under the name "TRIANGLES" and contains the formulas commonly used in calculations involving right-angled triangles.

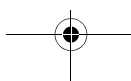



1. Open the Solve aplet and save it under the new name.

Solve  
   
 TRIANGLES



2. Enter the four formulas:

$\theta$   
    $\circ$   
  H   
   $\theta$     
 A   
 H   
   $\theta$     
  $\circ$    A   
 A    B   
  C



3. Decide whether you want the aplet to operate in Degrees, Radians, or Grads.

MODES   
 Degrees



4. View the Aplet Library. The "TRIANGLES" aplet is listed in the Aplet Library.

The Solve aplet can now be reset and used for other problems.

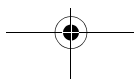

## Using a customized aplet

To use the “Triangles” aplet, simply select the appropriate formula, change to the Numeric view and solve for the missing variable.

Find the length of a ladder leaning against a vertical wall if it forms an angle of  $35^\circ$  with the horizontal and extends 5 metres up the wall.

1. Select the aplet.

**APLET** TRIANGLES  
**START**

```

XXXXXXXXXXXXXXXXXXXXXXXXXXXXXXXXXXXXXXXXXXXXXXXXXXXXXXXXXXXXXXXXXXXXXXXXXXXX
XXXXXXXXXXXXXXXXXXXXXXXXXXXXXXXXXXXXXXXXXXXXXXXXXXXXXXXXXXXXXXXXXXXXXXXXXXXX
E1: SIN(θ)=O/H
E2: COS(θ)=A/H
E3: TAN(θ)=O/A
✓E4: A²+B²=C²
E5:
XXXXXXXXXXXXXXXXXXXXXXXXXXXXXXXXXXXXXXXXXXXXXXXXXXXXXXXXXXXXXXXXXXXXXXXXXXXX
XXXXXXXXXXXXXXXXXXXXXXXXXXXXXXXXXXXXXXXXXXXXXXXXXXXXXXXXXXXXXXXXXXXXXXXXXXXX
EDIT ✓CHK = | SHOW EVAL
    
```

2. Choose the sine formula in E1.

**▲ ▲ ▲ ▲ ✓CHK**

```

XXXXXXXXXXXXXXXXXXXXXXXXXXXXXXXXXXXXXXXXXXXXXXXXXXXXXXXXXXXXXXXXXXXXXXXXXXXX
XXXXXXXXXXXXXXXXXXXXXXXXXXXXXXXXXXXXXXXXXXXXXXXXXXXXXXXXXXXXXXXXXXXXXXXXXXXX
✓E1: SIN(θ)=O/H
E2: COS(θ)=A/H
E3: TAN(θ)=O/A
E4: A²+B²=C²
E5:
XXXXXXXXXXXXXXXXXXXXXXXXXXXXXXXXXXXXXXXXXXXXXXXXXXXXXXXXXXXXXXXXXXXXXXXXXXXX
XXXXXXXXXXXXXXXXXXXXXXXXXXXXXXXXXXXXXXXXXXXXXXXXXXXXXXXXXXXXXXXXXXXXXXXXXXXX
EDIT ✓CHK = | SHOW EVAL
    
```

3. Change to the Numeric view and enter the known values.

**NUM**

35 **ENTER**

5 **ENTER**

```

XXXXXXXXXXXXXXXXXXXXXXXXXXXXXXXXXXXXXXXXXXXXXXXXXXXXXXXXXXXXXXXXXXXXXXXXXXXX
XXXXXXXXXXXXXXXXXXXXXXXXXXXXXXXXXXXXXXXXXXXXXXXXXXXXXXXXXXXXXXXXXXXXXXXXXXXX
XXXXXXXXXXXXXXXXXXXXXXXXXXXXXXXXXXXXXXXXXXXXXXXXXXXXXXXXXXXXXXXXXXXXXXXXXXXX
θ: 35
D: 5
H: 0
XXXXXXXXXXXXXXXXXXXXXXXXXXXXXXXXXXXXXXXXXXXXXXXXXXXXXXXXXXXXXXXXXXXXXXXXXXXX
XXXXXXXXXXXXXXXXXXXXXXXXXXXXXXXXXXXXXXXXXXXXXXXXXXXXXXXXXXXXXXXXXXXXXXXXXXXX
ENTER VALUE OR PRESS SOLVE
EDIT INFO | DEFN SOLVE
    
```

4. Solve for the missing value.

**SOLVE**

The length of the ladder is approximately 8.72 metres

```

XXXXXXXXXXXXXXXXXXXXXXXXXXXXXXXXXXXXXXXXXXXXXXXXXXXXXXXXXXXXXXXXXXXXXXXXXXXX
XXXXXXXXXXXXXXXXXXXXXXXXXXXXXXXXXXXXXXXXXXXXXXXXXXXXXXXXXXXXXXXXXXXXXXXXXXXX
XXXXXXXXXXXXXXXXXXXXXXXXXXXXXXXXXXXXXXXXXXXXXXXXXXXXXXXXXXXXXXXXXXXXXXXXXXXX
θ: 35
D: 5
H: 8.7172389781
XXXXXXXXXXXXXXXXXXXXXXXXXXXXXXXXXXXXXXXXXXXXXXXXXXXXXXXXXXXXXXXXXXXXXXXXXXXX
XXXXXXXXXXXXXXXXXXXXXXXXXXXXXXXXXXXXXXXXXXXXXXXXXXXXXXXXXXXXXXXXXXXXXXXXXXXX
ENTER VALUE OR PRESS SOLVE
EDIT INFO | DEFN SOLVE
    
```

## Resetting an aplet

Resetting an aplet clears all data and resets all default settings.

To reset an aplet, open the Library, select the aplet and press **RESET**.

You can only reset an aplet that is based on a built-in aplet if the programmer who created it has provided a Reset option.



## Annotating an applet with notes

The Note view (**[SHIFT]**NOTE) attaches a note to the current applet. See Chapter 20, "Notes and sketches".

## Annotating an applet with sketches

The Sketch view (**[SHIFT]**SKETCH) attaches a picture to the current applet. See chapter 20, "Notes and sketches".

### HINT

Notes and sketches that you attach to an applet become part of the applet. When you transfer the applet to another calculator, the associated note and sketch are transferred as well.

## Downloading e-lessons from the web

In addition to the standard applets that come with the calculator, you can download applets from the world wide web. For example, Hewlett-Packard's Calculators web site contains applets that demonstrate certain mathematical concepts. Note that you need the Graphing Calculator Connectivity Kit in order to load applets from a PC.

Hewlett-Packard's Calculators web site can be found at:

**<http://www.hp.com/calculators>**

## Sending and receiving applets

A convenient way to distribute or share problems in class and to turn in homework is to transmit (copy) applets directly from one HP 40gs to another. This can take place via a suitable cable. ( You can use a serial cable with a 4-pin mini-USB connector, which plugs into the RS232 port on the calculator. The serial cable is available as a separate accessory.)

You can also send applets to, and receive applets from, a PC. This requires special software running on the PC (such as the PC Connectivity Kit). A USB cable with a 5-pin mini-USB connector is provided with the hp40gs for connecting with a PC. It plugs into the USB port on the calculator.

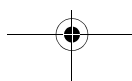
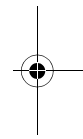
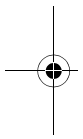



## To transmit an aplet

1. Connect the PC or aplet disk drive to the calculator by an appropriate cable.

2. Sending calculator: Open the Library, highlight the aplet to send, and press **SEND**.

- The **SEND TO** menu appears with the following options:

**HP39/40 (USB)** = to send via the USB port

**HP39/40 (SER)** = to send via the RS232 serial port

**USB DISK DRIVE** = to send to a disk drive via the USB port

**SER. DISK DRIVE** = to send to a disk drive via the RS232 serial port

*Note:* choose a disk drive option if you are using the hp40gs connectivity kit to transfer the aplet.

Highlight your selection and press **OK**.

- If transmitting to a disk drive, you have the options of sending to the current (default) directory or to another directory.

3. Receiving calculator: Open the aplet library and press **RECV**.

- The **RECEIVE FROM** menu appears with the following options:

**HP39/40 (USB)** = to receive via the USB port

**HP39/40 (SER)** = to receive via the RS232 serial port

**USB DISK DRIVE** = to receive from a disk drive via the USB port

**SER. DISK DRIVE** = to receive from a disk drive via the RS232 serial port

*Note:* choose a disk drive option if you are using the hp40gs connectivity kit to transfer the aplet.

Highlight your selection and press **OK**.

The Transmit annunciator—**↔**—is displayed until transmission is complete.

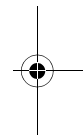
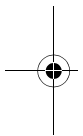



If you are using the PC Connectivity Kit to download aplets from a PC, you will see a list of aplets in the PC's current directory. Check as many items as you would like to receive.

## Sorting items in the aplet library menu list

Once you have entered information into an aplet, you have defined a new version of an aplet. The information is automatically saved under the current aplet name, such as "Function." To create additional aplets of the same type, you must give the current aplet a new name.

The advantage of storing an aplet is to allow you to keep a copy of a working environment for later use.

The aplet library is where you go to manage your aplets. Press **[APLET]**. Highlight (using the arrow keys) the name of the aplet you want to act on.

### To sort the aplet list

In the aplet library, press **[SORT]**. Select the sorting scheme and press **[ENTER]**.

- **Chronologically** produces a chronological order based on the date an aplet was last used. (The last-used aplet appears first, and so on.)
- **Alphabetically** produces an alphabetical order by aplet name.

### To delete an aplet

You cannot delete a built-in aplet. You can only clear its data and reset its default settings.

To delete a customized aplet, open the aplet library, highlight the aplet to be deleted, and press **[DEL]**. To delete all custom aplets, press **[SHIFT] CLEAR**.

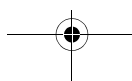
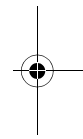
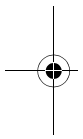



## Reference information

---

### Glossary

aplet	A small application, limited to one topic. The built-in aplet types are Function, Parametric, Polar, Sequence, Solve, Statistics, Inference, Finance, Trig Explorer, Quad Explorer, Linear Explorer and Triangle Solve. An aplet can be filled with the data and solutions for a specific problem. It is reusable (like a program, but easier to use) and it records all your settings and definitions.
command	An operation for use in programs. Commands can store results in variables, but do not display results. Arguments are separated by semicolons, such as <code>DISP expression; line#</code> .
expression	A number, variable, or algebraic expression (numbers plus functions) that produces a value.
function	An operation, possibly with arguments, that returns a result. It does not store results in variables. The arguments must be enclosed in parentheses and separated with commas (or periods in Comma mode), such as <code>CROSS(matrix1, matrix2)</code> .
HOME	The basic starting point of the calculator. Go to HOME to do calculations.
Library	For aplet management: to start, save, reset, send and receive aplets.

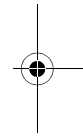
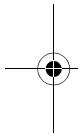



- list** A set of values separated by commas (periods if the Decimal Mark mode is set to `Comma`) and enclosed in braces. Lists are commonly used to enter statistical data and to evaluate a function with multiple values. Created and manipulated by the List editor and catalog.
- matrix** A two-dimensional array of values separated by commas (periods if the Decimal Mark mode is set to `Comma`) and enclosed in nested brackets. Created and manipulated by the Matrix catalog and editor. Vectors are also handled by the Matrix catalog and editor.
- menu** A choice of options given in the display. It can appear as a list or as a set of *menu-key labels* across the bottom of the display.
- menu keys** The top row of keys. Their operations depend on the current context. The labels along the bottom of the display show the current meanings.
- note** Text that you write in the Notepad or in the Note view for a specific applet.
- program** A reusable set of instructions that you record using the Program editor.
- sketch** A drawing that you make in the Sketch view for a specific applet.
- variable** The name of a number, list, matrix, note, or graphic that is stored in memory. Use **STO** to store and use **VAR** to retrieve.
- vector** A one-dimensional array of values separated by commas (periods if the Decimal Mark mode is set to `Comma`) and enclosed in single brackets. Created and manipulated by the Matrix catalog and editor.

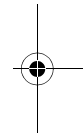
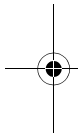





views

The possible contexts for an aplet: Plot, Plot Setup, Numeric, Numeric Setup, Symbolic, Symbolic Setup, Sketch, Note, and special views like split screens.



## Resetting the HP 40gs

If the calculator “locks up” and seems to be stuck, you must **reset** it. This is much like resetting a PC. It cancels certain operations, restores certain conditions, and clears temporary memory locations. However, it does *not* clear stored data (variables, aplet databases, programs) *unless* you use the procedure, “To erase all memory and reset defaults”.

### To reset using the keyboard

Press and hold the  key and the third menu key simultaneously, then release them.

If the calculator does not respond to the above key sequence, then:

1. Turn the calculator over and locate the small hole in the back of the calculator.
2. Insert the end of a straightened metal paper clip into the hole as far as it will go. Hold it there for 1 second, then remove it.
3. Press  If necessary, press  and the first and last menu keys simultaneously. (Note: This will erase your calculator memory.)

### To erase all memory and reset defaults

If the calculator does not respond to the above resetting procedures, you might need to restart it by erasing all of memory. *You will lose everything you have stored.* All factory-default settings are restored.

1. Press and hold the  key, the first menu key, and the last menu key simultaneously.
2. Release all keys in the reverse order.

*Note: To cancel this process, release only the top-row keys, then press the third menu key.*

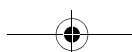
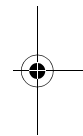
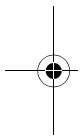



## If the calculator does not turn on

If the HP 40gs does not turn on follow the steps below until the calculator turns on. You may find that the calculator turns on before you have completed the procedure. If the calculator still does not turn on, please contact Customer Support for further information.

1. Press and hold the **ON** key for 10 seconds.
2. Press and hold the **ON** key and the third menu key simultaneously. Release the third menu key, then release the **ON** key.
3. Press and hold the **ON** key, the first menu key, and the sixth menu key simultaneously. Release the sixth menu key, then release the first menu key, and then release the **ON** key.
4. Locate the small hole in the back of the calculator. Insert the end of a straightened metal paper clip into the hole as far as it will go. Hold it there for 1 second, then remove it. Press the **ON** key.
5. Remove the batteries (see "Batteries" on page R-4), press and hold the **ON** key for 10 seconds, and then put the batteries back in. Press the **ON** key.

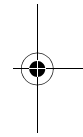
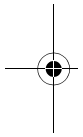

## Operating details

**Operating temperature:** 0° to 45°C (32° to 113°F).

**Storage temperature:** -20° to 65°C (-4° to 149°F).

**Operating and storage humidity:** 90% relative humidity at 40°C (104°F) maximum. *Avoid getting the calculator wet.*

Battery operates at 6.0V dc, 80mA maximum.

## Batteries

The calculator uses 4 AAA(LR03) batteries as main power and a CR2032 lithium battery for memory backup.

Before using the calculator, please install the batteries according to the following procedure.

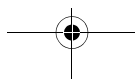



### To install the main batteries

- Slide up the battery compartment cover as illustrated.
- Insert 4 new AAA (LR03) batteries into the main compartment. Make sure each battery is inserted in the indicated direction.

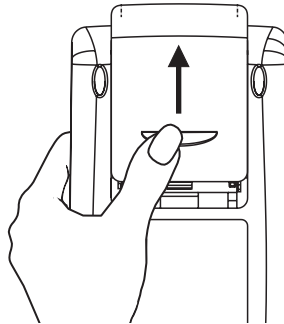

### To install the backup battery

- Press down the holder. Push the plate to the shown direction and lift it.

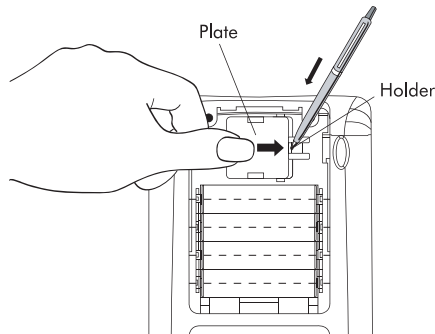

- Insert a new CR2032 lithium battery. Make sure its positive (+) side is facing up.
- Replace the plate and push it to the original place.

After installing the batteries, press **ON** to turn the power on.

**Warning:** It is recommended that you replace this battery every 5 years. When the low battery icon is displayed, you need to replace the batteries as soon as possible. However, avoid removing the backup battery and main batteries at the same time to avoid data lost.

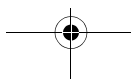
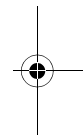
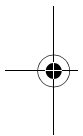



# Variables

## Home variables

The home variables are:

Category	Available name
Complex	Z1...Z9, Z0
Graphic	G1...G9, G0
Library	Function Parametric Polar Sequence Solve Statistics <i>User-named</i>
List	L1...L9, L0
Matrix	M1...M9, M0
Modes	Ans Date HAngle HDigits HFormat Ierr Time
Notepad	<i>User-named</i>
Program	Editline <i>User-named</i>
Real	A...Z, $\theta$

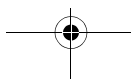
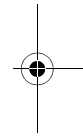
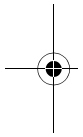



## Function applet variables

The function applet variables are:

Category	Available name		
Plot	Axes	Xcross	
	Connect	Ycross	
	Coord	Xtick	
	FastRes	Ytick	
	Grid	Xmin	
	Indep	Xmax	
	InvCross	Ymin	
	Labels	Ymax	
	Recenter	Xzoom	
	Simult	Yzoom	
	Tracing		
	Plot-FCN	Area	Root
		Extremum	Slope
Isect			
Symbolic	Angle	F6	
	F1	F7	
	F2	F8	
	F3	F9	
	F4	F0	
	F5		
Numeric	Digits	NumRow	
	Format	NumStart	
	NumCol	NumStep	
	NumFont	NumType	
	NumIndep	NumZoom	
Note	NoteText		
Sketch	Page	PageNum	

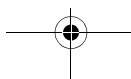
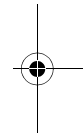
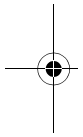



## Parametric applet variables

The parametric applet variables are:

Category	Available name		
Plot	Axes	Tracing	
	Connect	Tstep	
	Coord	Xcross	
	Grid	Ycross	
	Indep	Xtick	
	InvCross	Ytick	
	Labels	Xmin	
	Recenter	Xmax	
	Simult	Ymin	
	Tmin	Ymax	
	Tmax	Xzoom	
		Yzoom	
	Symbolic	Angle	Y5
		X1	X6
		Y1	Y6
		X2	X7
Y2		Y7	
X3		X8	
Y3		Y8	
X4		X9	
Y4		Y9	
X5		X0	
		Y0	
Numeric	Digits	NumRow	
	Format	NumStart	
	NumCol	NumStep	
	NumFont	NumType	
	NumIndep	NumZoom	
Note	NoteText		
Sketch	Page	PageNum	

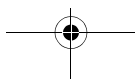
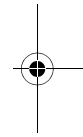
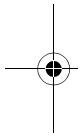



## Polar aplet variables

The polar aplet variables are:

Category	Available names		
Plot	Axes		
	Connect	Xcross	
	Coord	Ycross	
	Grid	Xtick	
	Indep	Ytick	
	InvCross	Xmin	
	Labels	Xmax	
	Recenter	Ymin	
	Simult	Ymax	
	Umin	Xzoom	
	Umax	Yzoom	
	$\theta$ step		
	Tracing		
	Symbolic	Angle	R6
		R1	R7
R2		R8	
R3		R9	
R4		R0	
R5			
Numeric	Digits	NumRow	
	Format	NumStart	
	NumCol	NumStep	
	NumFont	NumType	
	NumIndep	NumZoom	
Note	NoteText		
Sketch	Page	PageNum	

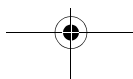
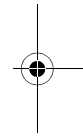
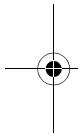



## Sequence applet variables

The sequence applet variables are:

Category	Available name	
Plot	Axes	Tracing
	Coord	Xcross
	Grid	Ycross
	Indep	Xtick
	InvCross	Ytick
	Labels	Xmin
	Nmin	Xmax
	Nmax	Ymin
	Recenter	Ymax
	SeqPlot	Xzoom
	Simult	Yzoom
	Symbolic	Angle
U1		U7
U2		U8
U3		U9
U4		U0
U5		
Numeric		Digits
	Format	NumStart
	NumCol	NumStep
	NumFont	NumType
	NumIndep	NumZoom
	Note	NoteText
Sketch	Page	PageNum

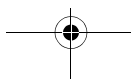
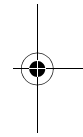
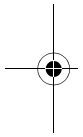





## Solve aplet variables

The solve aplet variables are:

Category	Available name	
Plot	Axes	Xcross
	Connect	Ycross
	Coord	Xtick
	FastRes	Ytick
	Grid	Xmin
	Indep	Xmax
	InvCross	Ymin
	Labels	Ymax
	Recenter	Xzoom
	Tracing	Yzoom
	Symbolic	Angle
E1		E7
E2		E8
E3		E9
E4		E0
E5		
Numeric	Digits	NumCol
	Format	NumRow
Note	NoteText	
Sketch	Page	PageNum

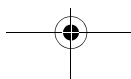
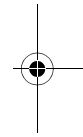
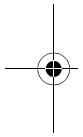



## Statistics applet variables

The statistics applet variables are:

Category	Available name		
Plot	Axes	S4mark	
	Connect	S5mark	
	Coord	StatPlot	
	Grid	Tracing	
	Hmin	Xcross	
	Hmax	Ycross	
	Hwidth	Xtick	
	Indep	Ytick	
	InvCross	Xmin	
	Labels	Xmax	
	Recenter	Ymin	
	S1mark	Ymax	
	S2mark	Xzoom	
	S3mark	Yzoom	
	Symbolic	Angle	S3fit
		S1fit	S4fit
S2fit		S5fit	
Numeric	C0, ... C9	NumFont	
	Digits	NumRow	
	Format	StatMode	
	NumCol		
Stat-One	Max $\Sigma$	Q3	
	Mean $\Sigma$	PSDev	
	Median	SSDev	
	Min $\Sigma$	PVar $\Sigma$	
	N $\Sigma$	SVar $\Sigma$	
	Q1	Tot $\Sigma$	
Stat-Two	Corr	$\Sigma X$	
	Cov	$\Sigma X^2$	
	Fit	$\Sigma XY$	
	MeanX	$\Sigma Y$	
	MeanY	$\Sigma Y^2$	
	RelErr		
Note	NoteText		
Sketch	Page	PageNum	

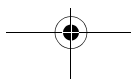
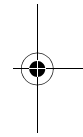
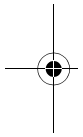



## MATH menu categories

### Math functions

The math functions are:

Category	Available name	
Calculus	$\partial$	
	$\int$	
	TAYLOR	
Complex	ARG	IM
	CONJ	RE
Constant	e	MAXREAL
	i	MINREAL
		$\pi$
Hyperb.	ACOSH	TANH
	ASINH	ALOG
	ATANH	EXP
	COSH	EXPM1
	SINH	LNP1
List	CONCAT	REVERSE
	$\Delta$ LIST	SIZE
	MAKELIST	$\Sigma$ LIST
	$\pi$ LIST	SORT
	POS	
Loop	ITERATE	
	RECURSE	
	$\Sigma$	

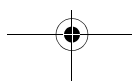
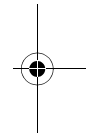
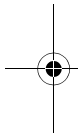



Category	Available name (Continued)		
Matrix	COLNORM	QR	
	COND	RANK	
	CROSS	ROWNORM	
	DET	RREF	
	DOT	SCHUR	
	EIGENVAL	SIZE	
	EIGENVV	SPECNORM	
	IDENMAT	SPECRAD	
	INVERSE	SVD	
	LQ	SVL	
	LSQ	TRACE	
	LU	TRN	
	MAKEMAT		
	Polynom.	POLYCOEF	POLYFORM
		POLYEVAL	POLYROOT
Prob.	COMB	UTPC	
	!	UTPF	
	PERM	UTPN	
	RANDOM	UTPT	
Real	CEILING	MIN	
	DEG→RAD	MOD	
	FLOOR	%	
	FNROOT	%CHANGE	
	FRAC	%TOTAL	
	HMS→	RAD→DEG	
	→HMS	ROUND	
	INT	SIGN	
	MANT	TRUNCATE	
	MAX	XPON	
	Stat-Two	PREDX	
PREDY			
Symbolic	=	QUAD	
	ISOLATE	QUOTE	
	LINEAR?		

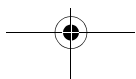
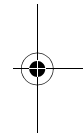
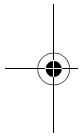



Category	Available name (Continued)	
Tests	<	AND
	≤	IFTE
	≠	NOT
	==	OR
	≠	XOR
	>	
Trig	≥	
	ACOT	COT
	ACSC	CSC
	ASEC	SEC

## Program constants

The program constants are:

Category	Available name	
Angle	Degrees	
	Grads	
	Radians	
Format	Standard	Sci
	Fixed	Eng
		Fraction
SeqPlot	Cobweb	
	Stairstep	
Sl...5fit	Linear	QuadFit
	LogFit	Cubic
	ExpFit	Logist
	Power	User
	Trigonometric	Exponent
StatMode	Stat1Var	
	Stat2Var	
StatPlot	Hist	
	BoxW	

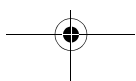
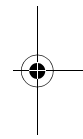
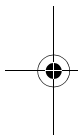



## Physical Constants

The physical constants are:

Category	Available Name
Chemist	<ul style="list-style-type: none"> <li>• Avogadro (Avagadro's Number, NA)</li> <li>• Boltz. (Boltmann, k)</li> <li>• mol. vo... (molar volume, Vm)</li> <li>• univ gas (universal gas, R)</li> <li>• std temp (standard temperature, St dT)</li> <li>• std pres (standard pressure, St dP)</li> </ul>
Phyics	<ul style="list-style-type: none"> <li>• StefBolt (Stefan-Boltzmann, <math>\sigma</math>)</li> <li>• light s... (speed of light, c)</li> <li>• permitti (permittivity, <math>\epsilon_0</math>)</li> <li>• permeab (permeability, <math>\mu_0</math>)</li> <li>• acce gr... (acceleration of gravity, g)</li> <li>• gravita... (gravitation, G)</li> </ul>
Quantum	<ul style="list-style-type: none"> <li>• Plank's (Plank's constant, h)</li> <li>• Dirac's (Dirac's, <math>\hbar</math>)</li> <li>• e charge (electronic charge, q)</li> <li>• e mass (electron mass, me)</li> <li>• q/me ra... (q/me ratio, qme)</li> <li>• proton m (proton mass, mp)</li> <li>• mp/me r... (mp/me ratio, mpme)</li> <li>• fine str (fine structure, <math>\alpha</math>)</li> <li>• mag flux (magnetic flux, <math>\phi</math>)</li> <li>• Faraday (Faraday, F)</li> <li>• Rydberg (Rydberg, <math>R_\infty</math>)</li> <li>• Bohr rad (Bohr radius, <math>a_0</math>)</li> <li>• Bohr mag (Bohr magneton, <math>\mu_B</math>)</li> <li>• nuc. mag (nuclear magneton, <math>\mu_N</math>)</li> <li>• photon... (photon wavelength, <math>\lambda</math>)</li> <li>• photon... (photon frequency, <math>f_0</math>)</li> <li>• Compt w... (Compton wavelength, <math>\lambda_c</math>)</li> </ul>

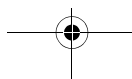
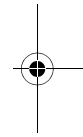
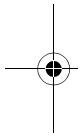



## CAS functions

CAS functions are:

Category	Function	
Algebra	COLLECT	STORE
	DEF	
	EXPAND	SUBST
	FACTOR	TEXPAND
	PARTFRAC	UNASSIGN
	QUOTE	
Complex	i	IM
	ABS	-
	ARG	RE
	CONJ	SIGN
	DROITE	
Constant	e	$\infty$
	i	$\pi$
Diff & Int	DERIV	PREVAL
	DERVX	RISCH
	DIVPC	SERIES
	FOURIER	TABVAR
	IBP	TAYLOR0
	INTVX	TRUNC
	lim	
Hyperb.	ACOSH	COSH
	ASINH	SINH
	ATANH	TANH
Integer	DIVIS	Iremainder
	EULER	ISPRIME?
	FACTOR	LCM
	GCD	MOD
	IDIV2	NEXTPRIME
	IEGCD	PREVPRIME
	IQUOT	
Modular	ADDTMOD	INVMOD
	DIVMOD	MODSTO
	EXPANDMOD	MULTMOD
	FACTORMOD	POWMOD
	GCDMOD	SUBTMOD

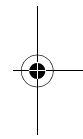
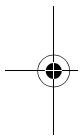



Category	Function (Continued)	
Polynom.	EGCD FACTOR GCD HERMITE LCM LEGENDRE	PARTFRAC PROPFRAC PTAYL QUOT REMAINDER TCHEBYCHEFF
Real	CEILING FLOOR FRAC	INT MAX MIN
Rewrite	DISTRIB EPSX0 EXPLN EXP2POW FDISTRIB LIN LNCOLLECT	POWEXPAND SINCOS SIMPLIFY XNUM XQ
Solve	DESOLVE ISOLATE LDEC	LINSOLVE SOLVE SOLVEVX
Tests	ASSUME UNASSUME > ≥ < ≤	= = ≠ AND OR NOT IFTE
Trig	ACOS2S ASIN2C ASIN2T ATAN2S HALFTAN SINCOS TAN2CS2 TAN2SC	TAN2SC2 TCOLLECT TEXPAMD TLIN TRIG TRIGCOS TRIGSIN TRIGTAN

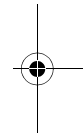
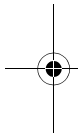





## Program commands

The program commands are:

Category	Command
Aplet	CHECK SELECT SETVIEWS UNCHECK
Branch	IF THEN ELSE END CASE IFERR RUN STOP
Drawing	ARC BOX ERASE FREEZE LINE PIXOFF PIXON TLINE
Graphic	DISPLAY→ →DISPLAY →GROB GROBNOT GROBOR GROBXOR MAKEGROB PLOT→ →PLOT REPLACE SUB ZEROGROB
Loop	FOR = TO STEP END DO UNTIL END WHILE REPEAT END BREAK
Matrix	ADDCOL ADDRROW DELCOL DELROW EDITMAT RANDMAT REDIM REPLACE SCALE SCALEADD SUB SWAPCOL SWAPROW
Print	PRDISPLAY PRHISTORY PRVAR
Prompt	BEEP CHOOSE CLRVAR DISP DISPXY DISPTIME EDITMAT FREEZE GETKEY INPUT MSGBOX PROMPT WAIT
Stat-One	DO1VSTATS RANDSEED SETFREQ SETSAMPLE

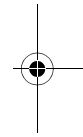
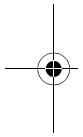



Category	Command (Continued)
Stat-Two	DO2VSTATS SETDEPEND SETINDEP

## Status messages

Message	Meaning
Bad Argument Type	Incorrect input for this operation.
Bad Argument Value	The value is out of range for this operation.
Infinite Result	Math exception, such as 1/0.
Insufficient Memory	You must recover some memory to continue operation. Delete one or more matrices, lists, notes, or programs (using catalogs), or custom (not built-in) aplets (using <b>SHIFT</b> <i>MEMORY</i> ).
Insufficient Statistics Data	Not enough data points for the calculation. For two-variable statistics there must be two columns of data, and each column must have at least four numbers.
Invalid Dimension	Array argument had wrong dimensions.
Invalid Statistics Data	Need two columns with equal numbers of data values.

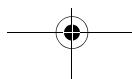
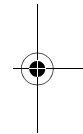
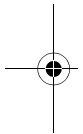



Message	Meaning (Continued)
Invalid Syntax	The function or command you entered does not include the proper arguments or order of arguments. The delimiters (parentheses, commas, periods, and semi-colons) must also be correct. Look up the function name in the index to find its proper syntax.
Name Conflict	The $\int$ (where) function attempted to assign a value to the variable of integration or summation index.
No Equations Checked	You must enter and check an equation (Symbolic view) before evaluating this function.
(OFF SCREEN)	Function value, root, extremum, or intersection is not visible in the current screen.
Receive Error	Problem with data reception from another calculator. Re-send the data.
Too Few Arguments	The command requires more arguments than you supplied.
Undefined Name	The global variable named does not exist.
Undefined Result	The calculation has a mathematically undefined result (such as $0/0$ ).
Out of Memory	You must recover a lot of memory to continue operation. Delete one or more matrices, lists, notes, or programs (using catalogs), or custom (not built-in) aplets (using <b>SHIFT</b> <b>MEMORY</b> ).

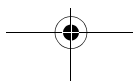
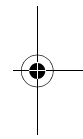
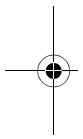

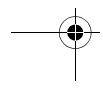
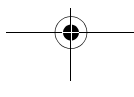
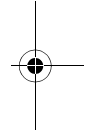
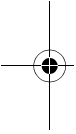
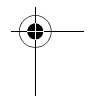
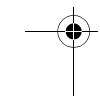
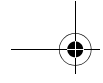



## Limited Warranty

---

HP 40gs Graphing Calculator; Warranty period: 12 months

1. HP warrants to you, the end-user customer, that HP hardware, accessories and supplies will be free from defects in materials and workmanship after the date of purchase, for the period specified above. If HP receives notice of such defects during the warranty period, HP will, at its option, either repair or replace products which prove to be defective. Replacement products may be either new or like-new.
2. HP warrants to you that HP software will not fail to execute its programming instructions after the date of purchase, for the period specified above, due to defects in material and workmanship when properly installed and used. If HP receives notice of such defects during the warranty period, HP will replace software media which does not execute its programming instructions due to such defects.
3. HP does not warrant that the operation of HP products will be uninterrupted or error free. If HP is unable, within a reasonable time, to repair or replace any product to a condition as warranted, you will be entitled to a refund of the purchase price upon prompt return of the product with proof of purchase.
4. HP products may contain remanufactured parts equivalent to new in performance or may have been subject to incidental use.
5. Warranty does not apply to defects resulting from (a) improper or inadequate maintenance or calibration, (b) software, interfacing, parts or supplies not supplied by HP, (c) unauthorized modification or misuse, (d) operation outside of the published environmental specifications for the product, or (e) improper site preparation or maintenance.

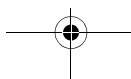
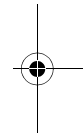
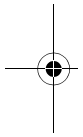



6. HP MAKES NO OTHER EXPRESS WARRANTY OR CONDITION WHETHER WRITTEN OR ORAL. TO THE EXTENT ALLOWED BY LOCAL LAW, ANY IMPLIED WARRANTY OR CONDITION OF MERCHANTABILITY, SATISFACTORY QUALITY, OR FITNESS FOR A PARTICULAR PURPOSE IS LIMITED TO THE DURATION OF THE EXPRESS WARRANTY SET FORTH ABOVE. Some countries, states or provinces do not allow limitations on the duration of an implied warranty, so the above limitation or exclusion might not apply to you. This warranty gives you specific legal rights and you might also have other rights that vary from country to country, state to state, or province to province.
7. TO THE EXTENT ALLOWED BY LOCAL LAW, THE REMEDIES IN THIS WARRANTY STATEMENT ARE YOUR SOLE AND EXCLUSIVE REMEDIES. EXCEPT AS INDICATED ABOVE, IN NO EVENT WILL HP OR ITS SUPPLIERS BE LIABLE FOR LOSS OF DATA OR FOR DIRECT, SPECIAL, INCIDENTAL, CONSEQUENTIAL (INCLUDING LOST PROFIT OR DATA), OR OTHER DAMAGE, WHETHER BASED IN CONTRACT, TORT, OR OTHERWISE. Some countries, States or provinces do not allow the exclusion or limitation of incidental or consequential damages, so the above limitation or exclusion may not apply to you.
8. The only warranties for HP products and services are set forth in the express warranty statements accompanying such products and services . HP shall not be liable for technical or editorial errors or omissions contained herein.

FOR CONSUMER TRANSACTIONS IN AUSTRALIA AND NEW ZEALAND: THE WARRANTY TERMS CONTAINED IN THIS STATEMENT, EXCEPT TO THE EXTENT LAWFULLY PERMITTED, DO NOT EXCLUDE, RESTRICT OR MODIFY AND ARE IN ADDITION TO THE MANDATORY STATUTORY RIGHTS APPLICABLE TO THE SALE OF THIS PRODUCT TO YOU.

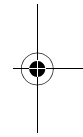
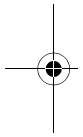



## Service

### Europe

Country :	Telephone numbers
Austria	+43-1-3602771203
Belgium	+32-2-7126219
Denmark	+45-8-2332844
Eastern Europe countries	+420-5-41422523
Finland	+35-89640009
France	+33-1-49939006
Germany	+49-69-95307103
Greece	+420-5-41422523
Holland	+31-2-06545301
Italy	+39-02-75419782
Norway	+47-63849309
Portugal	+351-229570200
Spain	+34-915-642095
Sweden	+46-851992065
Switzerland	+41-1-4395358 (German) +41-22-8278780 (French) +39-02-75419782 (Italian)
Turkey	+420-5-41422523
UK	+44-207-4580161
Czech Republic	+420-5-41422523
South Africa	+27-11-2376200
Luxembourg	+32-2-7126219
Other European countries	+420-5-41422523

### Asia Pacific

Country :	Telephone numbers
Australia	+61-3-9841-5211
Singapore	+61-3-9841-5211

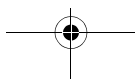
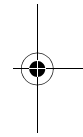
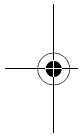



**L.America**

Country:	Telephone numbers
Argentina	0-810-555-5520
Brazil	Sao Paulo 3747-7799; ROTC 0-800-157751
Mexico	Mx City 5258-9922; ROTC 01-800-472-6684
Venezuela	0800-4746-8368
Chile	800-360999
Columbia	9-800-114726
Peru	0-800-10111
Central America & Caribbean	1-800-711-2884
Guatemala	1-800-999-5105
Puerto Rico	1-877-232-0589
Costa Rica	0-800-011-0524

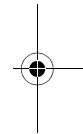
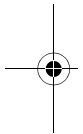

**N.America**

Country :	Telephone numbers
U.S.	1800-HP INVENT
Canada	(905) 206-4663 or 800- HP INVENT

ROTC = Rest of the country

Please logon to <http://www.hp.com> for the latest service and support information.h

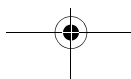





## Regulatory Notices

### Federal Communications Commission Notice

This equipment has been tested and found to comply with the limits for a Class B digital device, pursuant to Part 15 of the FCC Rules. These limits are designed to provide reasonable protection against harmful interference in a residential installation. This equipment generates, uses, and can radiate radio frequency energy and, if not installed and used in accordance with the instructions, may cause harmful interference to radio communications. However, there is no guarantee that interference will not occur in a particular installation. If this equipment does cause harmful interference to radio or television reception, which can be determined by turning the equipment off and on, the user is encouraged to try to correct the interference by one or more of the following measures:

- Reorient or relocate the receiving antenna.
- Increase the separation between the equipment and the receiver.
- Connect the equipment into an outlet on a circuit different from that to which the receiver is connected.
- Consult the dealer or an experienced radio or television technician for help.

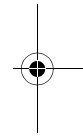
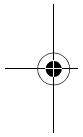

### Modifications

The FCC requires the user to be notified that any changes or modifications made to this device that are not expressly approved by Hewlett-Packard Company may void the user's authority to operate the equipment.

### Cables

Connections to this device must be made with shielded cables with metallic RFI/EMI connector hoods to maintain compliance with FCC rules and regulations.

### Declaration of Conformity for Products Marked with FCC Logo, United States Only

This device complies with Part 15 of the FCC Rules. Operation is subject to the following two conditions: (1) this device may not cause harmful interference, and (2) this device must accept any interference received, including interference that may cause undesired operation.

For questions regarding your product, contact:





Hewlett-Packard Company  
 P. O. Box 692000, Mail Stop 530113  
 Houston, Texas 77269-2000  
 Or, call  
 1-800-474-6836  
 For questions regarding this FCC declaration, contact:  
 Hewlett-Packard Company  
 P. O. Box 692000, Mail Stop 510101  
 Houston, Texas 77269-2000  
 Or, call  
 1-281-514-3333  
 To identify this product, refer to the part, series, or model  
 number found on the product.

**Canadian  
 Notice**

This Class B digital apparatus meets all requirements of  
 the Canadian Interference-Causing Equipment  
 Regulations.

**Avis Canadien**

Cet appareil numérique de la classe B respecte toutes les  
 exigences du Règlement sur le matériel brouilleur du  
 Canada.

**European Union  
 Regulatory  
 Notice**

This product complies with the following EU Directives:

- Low Voltage Directive 73/23/EEC
- EMC Directive 89/336/EEC

Compliance with these directives implies conformity to  
 applicable harmonized European standards (European  
 Norms) which are listed on the EU Declaration of  
 Conformity issued by Hewlett-Packard for this product or  
 product family.

This compliance is indicated by the following conformity  
 marking placed on the product:



This marking is valid for non-Telecom products  
 and EU harmonized Telecom products (e.g. Bluetooth).

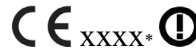

This marking is valid for EU non-harmonized Telecom products .  
 \*Notified body number (used only if applicable - refer to the product label)

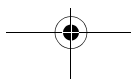



### Japanese Notice

この装置は、情報処理装置等電波障害自主規制協議会 (VCCI) の基準に基づくクラス B 情報技術装置です。この装置は、家庭環境で使用することを目的としていますが、この装置がラジオやテレビジョン受信機に近接して使用されると、受信障害を引き起こすことがあります。  
 取り扱い説明書に従って正しい取り扱いをしてください。

### Korean Notice

#### B급 기기 (가정용 정보통신기기)

이 기기는 가정용으로 전자파적합등록을 한 기기로서 주거지역에서는 물론 모든 지역에서 사용할 수 있습니다.

### Disposal of Waste Equipment by Users in Private Household in the European Union



This symbol on the product or on its packaging indicates that this product must not be disposed of with your other household waste. Instead, it is your responsibility to dispose of your waste equipment by handing it over to a designated collection point for the recycling of waste electrical and electronic equipment. The separate collection and recycling of your waste equipment at the time of disposal will help to conserve natural resources and ensure that it is recycled in a manner that protects human health and the environment. For more information about where you can drop off your waste equipment for recycling, please contact your local city office, your household waste disposal service or the shop where you purchased the product.

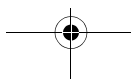
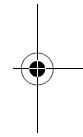
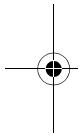

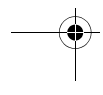
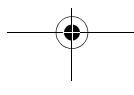
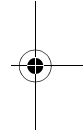
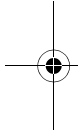
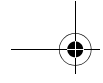



# Index

---

## A

ABCUV 14-62  
 ABS 14-45  
 absolute value 13-6  
 ACOS2S 14-38  
 add 13-4  
 ADDTMOD 14-51  
 ALGB menu 14-10  
 algebraic entry 1-19  
 alpha characters  
   typing 1-6  
 alphabetical sorting 22-6  
 angle measure 1-10  
   in statistics 10-12  
   setting 1-11  
 animation 20-5  
   creating 20-5  
 annunciators 1-3  
 Ans (last answer) 1-24  
 antiderivative 14-68, 14-69  
 antilogarithm 13-4, 13-10  
 aplet  
   attaching notes 22-4  
   clearing 22-3  
   copying 22-4  
   definition of R-1  
   deleting 22-6  
   Function 13-21  
   Inference 11-1  
   key 1-4  
   library 22-6  
   Linear Solver 8-1  
   opening 1-16  
   Parametric 4-1  
   Polar 5-1  
   receiving 22-5  
   resetting 22-3  
   sending 22-4, 22-5  
   Sketch view 20-1  
   Solve 7-1  
   sorting 22-6  
   statistics 10-1  
   transmitting 22-5  
   Triangle Solver 9-1  
 aplet commands

CHECK 21-14  
 SELECT 21-14  
 SETVIEWS 21-17  
 UNCHECK 21-17  
 aplet variables  
   definition 17-1, 17-8  
   in Plot view 21-31  
   new 17-1  
 aplet views  
   canceling operations in 1-1  
   changing 1-19  
   note 1-18  
   Numeric view 1-17  
   Plot view 1-16  
   sketch 1-18  
   split-screen 1-17  
   Symbolic view 1-16  
 approximation 14-32  
 arc cosecant 13-20  
 arc cosine 13-5  
 arc cotangent 13-20  
 arc secant 13-20  
 arc sine 13-4  
 arc tangent 13-5  
 area  
   graphical 3-10  
   interactive 3-10  
   variable 21-31  
 ARG 13-7  
 arguments  
   with matrices 18-10  
 ASIN2C 14-39  
 ASIN2T 14-39  
 ASSUME 14-61  
 ATAN2S 14-39  
 attaching  
   a note to an aplet 20-1  
   a sketch to an aplet 20-3  
 auto scale 2-14  
 axes  
   plotting 2-7  
   variable 21-31

## B

bad argument R-20

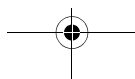
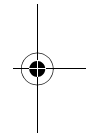
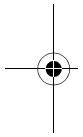

- bad guesses error message 7-7
- batteries R-4
- Bernoulli's number 14-65
- box-and-whisker plot 10-16
- branch commands
  - CASE...END 21-18
  - IF...THEN...ELSE...END 21-18
  - IFERR...THEN...ELSE 21-18
- branch structures 21-17
- build your own table 2-19
- C**
- calculus
  - operations 13-7
- CAS 14-1, 15-1
  - configuration 15-3
  - help 15-4
  - history 14-8
  - in HOME 14-7
  - list of functions 14-9, R-17
  - modes 14-5, 15-3
  - online help 14-8
  - variables 14-4
- catalogs 1-30
- CFG 15-3
- Chinese remainders 14-62, 14-65
- CHINREM 14-62
- chronological sorting 22-6
- circle drawing 20-4
- clearing
  - aplet 22-3
  - characters 1-22
  - display 1-22
  - display history 1-25
  - edit line 1-22
  - lists 19-6
  - plot 2-7
- cobweb graph 6-1
- coefficients
  - polynomial 13-11
- COLLECT 14-10
- columns
  - changing position 21-25
- combinations 13-12
- commands
  - aplet 21-14
  - branch 21-17
  - definition of R-1
  - drawing 21-19
  - graphic 21-21
  - loop 21-23
  - print 21-25
  - program 21-4, R-19
  - stat-one 21-29
  - stat-two 21-30
  - with matrices 18-10
- complex number functions 13-6, 13-17
  - conjugate 13-7
  - imaginary part 13-7
  - real part 13-8
- complex numbers 1-29
  - entering 1-29
  - math functions 13-7
  - storing 1-29
- computer algebra system *See* CAS
- confidence intervals 11-15
- CONJ 13-7
- conjugate 13-7
- connecting
  - data points 10-19
  - variable 21-31
  - via serial cable 22-5
  - via USB cable 22-5
- connectivity kit 22-4
- constant? error message 7-7
- constants
  - e 13-8
  - i 13-8
  - maximum real number 13-8
  - minimum real number 13-8
  - physical 1-8, 13-25, R-16
  - program R-15, R-16
- contrast
  - decreasing display 1-2
  - increasing display 1-2
- conversions 13-8
- coordinate display 2-9
- copying
  - display 1-22
  - graphics 20-6
  - notes 20-8
  - programs 21-8
- correlation
  - coefficient 10-17
  - CORR 10-17
  - statistical 10-15
- cosecant 13-20



cosine 13-4  
     inverse hyperbolic 13-9  
 cotangent 13-20  
 covariance  
     statistical 10-15  
 creating  
     aplet 22-1  
     lists 19-1  
     matrices 18-2  
     notes in Notepad 20-6  
     programs 21-4  
     sketches 20-3  
 critical value(s) displayed 11-4  
 cross product  
     vector 18-11  
 curve fitting 10-12, 10-17  
 CYCLOTOMIC 14-63

**D**

data set definition 10-8  
 date, setting 21-27  
 debugging programs 21-7  
 decimal  
     changing format 1-10  
     scaling 2-14, 2-15  
 decreasing display contrast 1-2  
 DEF 14-10  
 definite integral 13-6  
 deleting  
     aplet 22-6  
     lists 19-6  
     matrices 18-4  
     programs 21-9  
     statistical data 10-11  
 delimiters, programming 21-1  
 DERIV 14-16  
 derivative 14-16  
 derivatives  
     definition of 13-6  
     in Function aplet 13-22  
     in Home 13-21  
 DERVX 14-16  
 DESOLVE 14-33  
 determinant  
     square matrix 18-11  
 DIFF menu 14-16  
 differential equations 14-33, 14-35,  
 14-57

differentiation 13-6, 14-33  
 digamma function 14-67, 14-68  
 display 21-21  
     adjusting contrast 1-2  
     annunciator line 1-2  
     capture 21-21  
     clearing 1-2  
     date and time 21-27  
     element 18-5  
     elements 19-4  
     engineering 1-10  
     fixed 1-10  
     fraction 1-10  
     history 1-22  
     line 1-23  
     matrices 18-5  
     parts of 1-2  
     printing contents 21-25  
     rescaling 2-13  
     scientific 1-10  
     scrolling through history 1-25  
     soft key labels 1-2  
     standard 1-10  
 DISTRIB 14-28  
 distributivity 14-12, 14-28, 14-30  
 divide 13-4  
 DIVIS 14-47  
 DIVMOD 14-52  
 DIVPC 14-17  
 drawing  
     circles 20-4  
     keys 20-4  
     lines and boxes 20-3  
 drawing commands  
     ARC 21-19  
     BOX 21-20  
     ERASE 21-20  
     FREEZE 21-20  
     LINE 21-20  
     PIXOFF 21-20  
     PIXON 21-20  
     TLINE 21-20  
 DROITE 14-45

**E**

e 13-8  
 edit line 1-2  
 editing  
     matrices 18-4

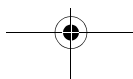
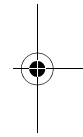
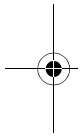



- notes 20-2
- programs 21-5
- Editline
  - Program catalog 21-2
- editors 1-30
- EGCD 14-55
- eigenvalues 18-11
- eigenvectors 18-11
- element
  - storing 18-6
- E-lessons 1-12
- engineering number format 1-11
- EPSX0 14-29
- equals
  - for equations 13-17
  - logical test 13-19
- Equation Writer 14-2, 15-1, 16-1
  - selecting terms 15-5
- equations
  - solving 7-1
- erasing a line in Sketch view 21-20
- error messages
  - bad guesses 7-7
  - constant? 7-7
- Euclidean division 14-48, 14-49
- EULER 14-47
- exclusive OR 13-20
- exiting views 1-19
- EXP2HYP 14-63
- EXP2POW 14-29
- EXPAND 14-12
- EXPANDMOD 14-52
- expansion 14-25, 14-27
- EXPLN 14-29
- exponent
  - fit 10-13
  - minus 1 13-10
  - of value 13-17
  - raising to 13-5
- exponentials 14-30, 14-63
- expression
  - defining 2-1, R-1
  - entering in HOME 1-19
  - evaluating in aplets 2-3
  - literal 13-18
  - plot 3-3
- extended greatest common divisor 14-55

- extremum 3-10
- F**
- FACTOR 14-12, 14-47, 14-56
- factorial 13-13
- factorization 14-12
- FACTORMOD 14-53
- FastRes variable 21-32
- FDISTRIB 14-30
- fit
  - a curve to 2VAR data 10-17
  - choosing 10-12
  - defining your own 10-13
- fixed number format 1-10
- font size
  - change 3-8, 15-2, 20-5
- forecasting 10-20
- FOURIER 14-17
- fraction number format 1-11
- full-precision display 1-10
- function
  - analyze graph with FCN tools 3-4
  - definition 2-2, R-1
  - entering 1-19
  - gamma 13-13
  - intersection point 3-5
  - math menu R-13, R-17
  - slope 3-5
  - syntax 13-2
  - tracing 2-8
- Function aplet 2-20, 3-1
- function variables
  - area 21-31
  - axes 21-31
  - connect 21-31
  - fastres 21-32
  - grid 21-32
  - in menu map R-7
  - indep 21-33
  - isect 21-33
  - labels 21-34
  - Recenter 21-34
  - root 21-34
  - ycross 21-37
- G**
- GAMMA 14-64
- GCD 14-47, 14-56
- GCDMOD 14-53

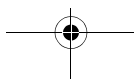
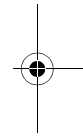
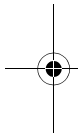



**glossary R-1****graph**

- analyzing statistical data in 10-19
- auto scale 2-14
- box-and-whisker 10-16
- capture current display 21-21
- cobweb 6-1
- comparing 2-5
- connected points 10-17
- defining the independent variable 21-36
- drawing axes 2-7
- expressions 3-3
- grid points 2-7
- histogram 10-15
- in Solve aplet 7-7
- one-variable statistics 10-18
- overlying 2-15
- scatter 10-15, 10-17
- split-screen view 2-14
- splitting into plot and close-up 2-13
- splitting into plot and table 2-13
- stairsteps 6-1
- statistical data 10-15
- t* values 2-6
- tickmarks 2-6
- tracing 2-8
- two-variable statistics 10-18

**Graphic commands**

- GROB 21-21
- DISPLAY→ 21-21
- GROBNOT 21-21
- GROBOR 21-21
- GROBXOR 21-22
- MAKEGROB 21-22
- PLOT→ 21-22
- REPLACE 21-22
- SUB 21-22
- ZEROGROB 21-22

**graphics**

- copying 20-6
- copying into Sketch view 20-6
- storing and recalling 20-6, 21-21

greatest common divisor 14-56

**H**

- HALFTAN 14-40
- HERMITE 14-56
- histogram 10-15

adjusting 10-16

range 10-18

setting min/max values for bars 21-32

width 10-18

history 1-2, 14-8, 21-25

Home 1-1

calculating in 1-19

display 1-2

evaluating expressions 2-4

reusing lines 1-23

variables 17-1, 17-7, R-6

home 14-7

horizontal zoom 21-38

hyperbolic

maths functions 13-10

hyperbolic trigonometry

ACOSH 13-9

ALOG 13-10

ASINH 13-9

ATANH 13-9

COSH 13-10

EXP 13-10

EXPM1 13-10

LNPN 13-10

SINH 13-10

TANH 13-10

hypothesis

alternative 11-2

inference tests 11-8

null 11-2

tests 11-2

**I***i* 13-8, 14-45

IABCUV 14-64

IBERNOULLI 14-65

IBP 14-18

ICHINREM 14-65

IDIV2 14-48

IEGCD 14-48

ILAP 14-65

IM 13-7

implied multiplication 1-20

importing

graphics 20-6

notes 20-8

increasing display contrast 1-2

indefinite integral

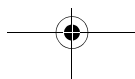
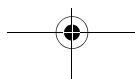
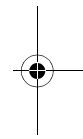
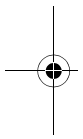

- using symbolic variables 13-23
- independent values
  - adding to table 2-19
- independent variable
  - defined for Tracing mode 21-33
- inference
  - confidence intervals 11-15
  - hypothesis tests 11-8
  - One-Proportion Z-Interval 11-17
  - One-Sample Z-Interval 11-15
  - One-Sample Z-Test 11-8
  - Two-Proportion Z-Interval 11-17
  - Two-Proportion Z-Test 11-11
  - Two-Sample T-Interval 11-19
  - Two-Sample Z-Interval 11-16
- infinite result R-20
- initial guess 7-5
- input forms
  - resetting default values 1-9
  - setting Modes 1-11
- insufficient memory R-20
- insufficient statistics data R-20
- integer rank
  - matrix 18-12
- integer scaling 2-14, 2-15
- integral
  - definite 13-6
  - indefinite 13-23
- integration 13-6, 14-18, 14-24
- interpreting
  - intermediate guesses 7-7
- intersection 3-11
- INTVX 14-19
- invalid
  - dimension R-20
  - statistics data R-20
  - syntax R-21
- inverse hyperbolic cosine 13-9
- inverse hyperbolic functions 13-10
- inverse hyperbolic sine 13-9
- inverse hyperbolic tangent 13-9
- inverse Laplace transform 14-66
- inverting matrices 18-8
- INVMOD 14-53
- IQUOT 14-49
- IREMAINDER 14-49
- isect variable 21-33
- ISOLATE 14-34

ISPRIME? 14-50

## K

keyboard
 

- editing keys 1-5
- entry keys 1-5
- inactive keys 1-8
- list keys 19-2
- math functions 1-7
- menu keys 1-4
- Notepad keys 20-8
- shifted keystrokes 1-6

## L

labeling
 

- axes 2-7
- parts of a sketch 20-5

LAP 14-67

Laplace transform 14-65

Laplace transform, inverse 14-66

LCM 14-50, 14-57

LDEC 14-35

least common multiple 14-50, 14-57

LEGENDRE 14-57

letters, typing 1-6

library, managing applets in 22-6

lim 14-21

limits 14-21

LIN 14-30

linear fit 10-13

Linear Solver applet 8-1

linear systems 14-35

linearize 14-30, 14-43

LINSOLVE 14-35

list
 

- arithmetic with 19-7
- calculate sequence of elements 19-8
- calculating product of 19-8
- composed from differences 19-7
- concatenating 19-7
- counting elements in 19-9
- creating 19-1, 19-3, 19-4, 19-5
- deleting 19-6
- deleting list items 19-3
- displaying 19-4
- displaying list elements 19-4
- editing 19-3



- finding statistical values in list elements 19-9
- generate a series 19-8
- list function syntax 19-6
- list variables 19-1
- returning position of element in 19-8
- reversing order in 19-8
- sending and receiving 19-6
- sorting elements 19-9
- storing elements 19-1, 19-4, 19-5
- storing one element 19-6
- INCOLLECT 14-31
- logarithm 13-4
- logarithmic
  - fit 10-13
  - functions 13-4
- logarithms 14-31
- logical operators
  - AND 13-19
  - equals (logical test) 13-19
  - greater than 13-19
  - greater than or equal to 13-19
  - IFTE 13-19
  - less than 13-19
  - less than or equal to 13-19
  - NOT 13-19
  - not equal to 13-19
  - OR 13-19
  - XOR 13-20
- logistic fit 10-13
- loop commands
  - BREAK 21-23
  - DO...UNTIL...END 21-23
  - FOR I= 21-23
  - WHILE...REPEAT...END 21-23
- loop functions
  - ITERATE 13-10
  - RECURSE 13-11
  - summation 13-11
- low battery 1-1
- lowercase letters 1-6
- M**
- mantissa 13-15
- math functions
  - complex number 13-7
  - hyperbolic 13-10
  - in menu map R-13, R-17
  - keyboard 13-3
  - logical operators 13-19
  - menu 1-7
  - polynomial 13-11
  - probability 13-12
  - real-number 13-14
  - symbolic 13-17
  - trigonometry 13-20
- MATH menu 13-1
- math operations 1-19
  - enclosing arguments 1-21
  - in scientific notation 1-20
  - negative numbers in 1-20
- matrices
  - adding rows 21-24
  - addition and subtraction 18-6
  - arguments 18-10
  - arithmetic operations in 18-6
  - assembly from vectors 18-1
  - changing row position 21-25
  - column norm 18-10
  - comma 19-7
  - commands 18-10
  - condition number 18-11
  - create identity 18-13
  - creating 18-3
  - creating in Home 18-5
  - deleting 18-4
  - deleting columns 21-24
  - deleting rows 21-24
  - determinant 18-11
  - display eigenvalues 18-11
  - displaying 18-5
  - displaying matrix elements 18-5
  - dividing by a square matrix 18-8
  - dot product 18-11
  - editing 18-4
  - extracting a portion 21-25
  - finding the trace of a square matrix 18-13
  - inverting 18-8
  - matrix calculations 18-1
  - multiplying and dividing by scalar 18-7
  - multiplying by vector 18-7
  - multiplying row by value and adding result to second row 21-25
  - multiplying row number by value 21-25
  - negating elements 18-8
  - opening Matrix Editor 21-28
  - raised to a power 18-7





- redimension 21-24
- replacing portion of matrix or vector 21-25
- sending or receiving 18-4
- singular value decomposition 18-13
- singular values 18-13
- size 18-12
- spectral norm 18-13
- spectral radius 18-13
- start Matrix Editor 21-24
- storing elements 18-3, 18-5
- storing matrix elements 18-6
- swap column 21-25
- swap row 21-25
- transposing 18-13
- variables 18-1
- matrix functions 18-10
  - COLNORM 18-10
  - COND 18-11
  - CROSS 18-11
  - DET 18-11
  - DOT 18-11
  - EIGENVAL 18-11
  - EIGENVV 18-11
  - IDENMAT 18-11
  - INVERSE 18-11
  - LQ 18-11
  - LSQ 18-11
  - LU 18-12
  - MAKEMAT 18-12
  - QR 18-12
  - RANK 18-12
  - ROWNORM 18-12
  - RREF 18-12
  - SCHUR 18-12
  - SIZE 18-12
  - SPECNORM 18-13
  - SPECRAD 18-13
  - SVD 18-13
  - SVL 18-13
  - TRACE 18-13
  - TRN 18-13
- maximum real number 1-22, 13-8
- memory R-20
  - clearing all R-3
  - organizing 17-9
  - out of R-21
  - saving 1-25, 22-1
  - viewing 17-1
- menu lists

- searching 1-9
- minimum real number 13-8
- mixed fraction format 1-11
- modes
  - angle measure 1-10
  - CAS 14-5
  - decimal mark 1-11
  - number format 1-10
- MODSTO 14-53
- modular arithmetic 14-51
- multiple solutions
  - plotting to find 7-7
- multiplication 13-4, 14-28
  - implied 1-20
- MULTMOD 14-54

## N

- name conflict R-21
- naming
  - programs 21-4
- natural exponential 13-4, 13-10
- natural log plus 1 13-10
- natural logarithm 13-4
- negation 13-5
- negative numbers 1-20
- NEXTPRIME 14-51
- no equations checked R-21
- non-rational 14-6
- Normal Z-distribution, confidence intervals 11-15
- note
  - copying 20-8
  - editing 20-2
  - importing 20-8
  - printing 21-26
  - viewing 20-1
  - writing 20-1
- Notepad 20-1
  - catalog keys 20-7
  - creating notes 20-6
  - writing in 20-6
- n*th root 13-6
- null hypothesis 11-2
- number format
  - engineering 1-11
  - fixed 1-10
  - fraction 1-11
  - in Solve aplet 7-5

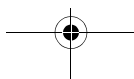
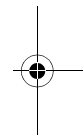
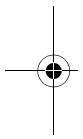



mixed fraction 1-11  
 scientific 1-10  
 Standard 1-10

numeric precision 17-9

Numeric view

adding values 2-19  
 automatic 2-16  
 build your own table 2-19  
 display defining function for column 2-17  
 recalculating 2-19  
 setup 2-16, 2-19

## O

off

automatic 1-1  
 power 1-1

on/cancel 1-1

One-Proportion Z-Interval 11-17

One-Sample T-Interval 11-18

One-Sample T-Test 11-12

One-Sample Z-Interval 11-15

One-Sample Z-Test 11-8

online help 14-8

order of precedence 1-21

overlying plots 2-15, 4-3

## P

$\pi$  13-8

PA2B2 14-67

paired columns 10-11

parametric variables

axes 21-31  
 connect 21-31  
 grid 21-32  
 in menu map R-8  
 indep 21-33  
 labels 21-34  
 recenter 21-34  
 ycross 21-37

parentheses

to close arguments 1-21  
 to specify order of operation 1-21

PARTFRAC 14-13, 14-57

partial derivative 14-16

partial fraction expansion 14-13

partial integration 14-18

pause 21-29

permutations 13-13

pictures

attaching in Sketch view 20-3

plot

analyzing statistical data in 10-19

auto scale 2-14

box-and-whisker 10-16

cobweb 6-1

comparing 2-5

connected points 10-17, 10-19

decimal scaling 2-14

defining the independent variable 21-36

drawing axes 2-7

expressions 3-3

grid points 2-7

histogram 10-15

in Solve aplet 7-7

integer scaling 2-14

one-variable statistics 10-18

overlay plot 2-13

overlying 2-15, 4-3

scaling 2-13

scatter 10-15, 10-17

sequence 2-6

setting up 2-5, 3-2

split-screen view 2-14

splitting 2-14

splitting into plot and close-up 2-13

splitting into plot and table 2-13

stairsteps 6-1

statistical data 10-15

statistics parameters 10-18

$t$  values 2-6

tickmarks 2-6

to capture current display 21-21

tracing 2-8

trigonometric scaling 2-14

two-variable statistics 10-18

plotting resolution

and tracing 2-8

plot-view variables

area 21-31

connect 21-31

fastres 21-32

function 21-31

grid 21-32

hmin/hmax 21-32

hwidth 21-33

isect 21-33

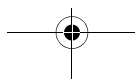
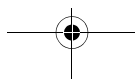
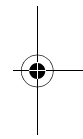
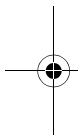

- labels 21-34
  - recenter 21-34
  - root 21-34
  - s1mark-s5mark 21-34
  - statplot 21-35
  - tracing 21-33
  - umin/umax 21-35
  - ustep 21-35
  - polar variables
    - axes 21-31
    - connect 21-31
    - grid 21-32
    - in menu map R-9
    - indep 21-33
    - labels 21-34
    - recenter 21-34
    - ycross 21-37
  - polynomial
    - coefficients 13-11
    - evaluation 13-11
    - form 13-12
    - roots 13-12
    - Taylor 13-7
  - polynomial functions
    - POLYCOEF 13-11
    - POLYEVAL 13-11
    - POLYFORM 13-12
    - POLYROOT 13-12
  - ports 22-5
  - position argument 21-21
  - power (x raised to y) 13-5
  - powers 14-6
  - POWEXPAND 14-31
  - POWMOD 14-54
  - precedence 1-22
  - predicted values
    - statistical 10-20
  - PREVAL 14-23
  - PREVPRIME 14-51
  - prime factors 14-47
  - prime numbers 14-50, 14-51
  - primitive 14-23, 14-24
  - print
    - contents of display 21-25
    - name and contents of variable 21-26
    - object in history 21-25
    - variables 21-26
  - probability functions
    - ! 13-13
    - COMB 13-12
    - RANDOM 13-13
    - UTPC 13-13
    - UTPF 13-13
    - UTPN 13-13
    - UTPT 13-14
  - program
    - commands 21-4
    - copying 21-8
    - creating 21-4
    - debugging 21-7
    - deleting 21-9
    - delimiters 21-1
    - editing 21-5
    - naming 21-4
    - pausing 21-29
    - printing 21-26
    - sending and receiving 21-8
    - structured 21-1
  - prompt commands
    - beep 21-26
    - create choose box 21-26
    - create input form 21-28
    - display item 21-27
    - display message box 21-29
    - halt program execution 21-29
    - insert line breaks 21-29
    - prevent screen display being updated 21-28
    - set date and time 21-27
    - store keycode 21-28
  - PROPFrac 14-58
  - PSI 14-67
  - Psi 14-68
  - PTAYL 14-58
- ## Q
- quadratic
    - extremum 3-6
    - fit 10-13
    - function 3-4
  - QUOT 14-58
  - QUOTE 14-13
  - quotes
    - in program names 21-4
- ## R
- random numbers 13-13



RE 13-8  
 real number  
   maximum 13-8  
   minimum 13-8  
 real part 13-8  
 real-number functions 13-14  
   % 13-16  
   %CHANGE 13-16  
   %TOTAL 13-16  
   CEILING 13-14  
   DEGtoRAD 13-14  
   FNROOT 13-14  
   HMSto 13-15  
   INT 13-15  
   MANT 13-15  
   MAX 13-15  
   MIN 13-15  
   MOD 13-15  
   RADtoDEG 13-16  
   ROUND 13-16  
   SIGN 13-16  
   TRUNCATE 13-17  
   XPON 13-17  
 reatest common divisor 14-47  
 recalculation for table 2-19  
 receive error R-21  
 receiving  
   aplet 22-5  
   lists 19-6  
   matrices 18-4  
   programs 21-8  
 redrawing  
   table of numbers 2-18  
 reduced row echelon 18-12  
 regression  
   analysis 10-17  
   fit models 10-13  
   formula 10-12  
   user-defined fit 10-13  
 relative error  
   statistical 10-18  
 REMAINDER 14-59  
 REORDER 14-68  
 resetting  
   aplet 22-3  
   calculator R-3  
   memory R-3  
 result  
   copying to edit line 1-22  
   reusing 1-22

rigorous 14-6  
 RISCH 14-24  
 root  
   interactive 3-10  
   nth 13-6  
   variable 21-34  
 root-finding  
   displaying 7-7  
   interactive 3-9  
   operations 3-10  
   variables 3-10

**S**

S1mark-S5mark variables 21-34  
 scaling  
   automatic 2-14  
   decimal 2-10, 2-14  
   integer 2-10, 2-14, 2-15  
   options 2-13  
   resetting 2-13  
   trigonometric 2-14  
 scatter plot 10-15, 10-17  
   connected 10-17, 10-19  
 SCHUR decomposition 18-12  
 scientific number format 1-10, 1-20  
 scrolling  
   in Trace mode 2-8  
 searching  
   menu lists 1-9  
   speed searches 1-9  
 secant 13-20  
 Sending 22-5  
 sending  
   aplets 22-4  
   lists 19-6  
   programs 21-8  
 sequence  
   definition 2-2  
 sequence variables  
   Axes 21-31  
   Grid 21-32  
   in menu map R-10  
   Indep 21-33  
   Labels 21-34  
   Recenter 21-34  
   Ycross 21-37  
 serial port connectivity 22-5  
 SERIES 14-24  
 setting

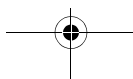

- date 21-27
- time 21-27
- SEVAL 14-68
- SIGMA 14-68
- SIGMAVX 14-69
- SIGN 14-46
- sign reversal 7-6
- SIMPLIFY 14-32
- simplify 14-68, 14-70
- SINCOS 14-31, 14-40
- sine 13-4
  - inverse hyperbolic 13-9
- singular value decomposition
  - matrix 18-13
- singular values
  - matrix 18-13
- sketches
  - creating 20-5
  - creating a blank graphic 21-22
  - creating a set of 20-5
  - erasing a line 21-20
  - labeling 20-5
  - opening view 20-3
  - sets 20-5
  - storing in graphics variable 20-5
- slope 3-10
- soft key labels 1-2
- SOLVE 14-37
- solve
  - error messages 7-7
  - initial guesses 7-5
  - interpreting intermediate guesses 7-7
  - interpreting results 7-6
  - plotting to find guesses 7-7
  - setting number format 7-5
- solve variables
  - axes 21-31
  - connect 21-31
  - fastres 21-32
  - grid 21-32
  - in menu map R-11
  - indep 21-33
  - labels 21-34
  - recenter 21-34
  - ycross 21-37
- SOLVEVX 14-38
- sorting 22-6
  - aplets in alphabetic order 22-6
  - aplets in chronological order 22-6
  - elements in a list 19-9
- spectral norm 18-13
- spectral radius 18-13
- square root 13-5
- stack history
  - printing 21-25
- stairsteps graph 6-1
- standard number format 1-10
- statistics
  - analysis 10-1
  - analyzing plots 10-19
  - angle mode 10-12
  - calculate one-variable 21-30
  - calculate two-variable 21-30
  - data set variables 21-40
  - data structure 21-40
  - define one-variable sample 21-30
  - define two-variable data set's dependent column 21-30
  - define two-variable data set's independent column 21-30
  - defining a fit 10-12
  - defining a regression model 10-12
  - deleting data 10-11
  - editing data 10-11
  - frequency 21-30
  - inserting data 10-11
  - plot type 10-18
  - plotting data 10-15
  - predicted values 10-20
  - regression curve (fit) models 10-12
  - saving data 10-10
  - sorting data 10-11
  - specifying angle setting 10-12
  - tooggling between one-variable and two-variable 10-12
  - tracing plots 10-19
  - troubleshooting with plots 10-19
  - zooming in plots 10-19
- statistics variables
  - Axes 21-31
  - Connect 21-31
  - Grid 21-32
  - Hmin/Hmax 21-32
  - Hwidth 21-33
  - in menu map R-12
  - Indep 21-33





- Labels 21-34
    - Recenter 21-34
    - S1mark-S5mark 21-34
    - Ycross 21-37
  - step size of independent variable 21-36
  - step-by-step 14-6
  - STORE 14-14
  - storing
    - list elements 19-1, 19-4, 19-5, 19-6
    - matrix elements 18-3, 18-5, 18-6
    - results of calculation 17-2
    - value 17-2
  - strings
    - literal in symbolic operations 13-18
  - STURMAB 14-69
  - SUBST 14-15
  - substitution 14-14
  - SUBTMOD 14-55
  - subtract 13-4
  - summation function 13-11
  - symbolic
    - calculations in Function applet 13-21
    - defining expressions 2-1
    - differentiation 13-21
    - displaying definitions 3-8
    - evaluating variables in view 2-3
    - setup view for statistics 10-12
  - symbolic calculations 14-1
  - symbolic functions
    - | (where) 13-18
    - equals 13-17
    - ISOLATE 13-17
    - LINEAR? 13-18
    - QUAD 13-18
    - QUOTE 13-18
  - Symbolic view
    - defining expressions 3-2
  - syntax 13-2
  - syntax errors 21-7
- T**
- table
    - navigate around 3-8
    - numeric values 3-7
    - numeric view setup 2-16
  - TABVAR 14-27
  - TAN2CS2 14-40
  - TAN2SC 14-41
  - TAN2SC2 14-41
  - tangent 13-4
    - inverse hyperbolic 13-9
  - Taylor polynomial 13-7
  - TAYLOR0 14-27
  - TCHEBYCHEFF 14-59
  - TCOLLECT 14-41
  - tests 14-61
  - TEXPAND 14-15, 14-42
  - tickmarks for plotting 2-6
  - time 13-15
    - setting 21-27
  - time, converting 13-15
  - times sign 1-20
  - TLIN 14-43
  - tmax 21-36
  - tmin 21-36
  - too few arguments R-21
  - TOOL menu 15-1
  - tracing
    - functions 2-8
    - more than one curve 2-8
    - not matching plot 2-8
    - plots 2-8
  - transcendental expressions 14-42
  - transmitting
    - lists 19-6
    - matrices 18-4
    - programs 21-8
  - transposing a matrix 18-13
  - Triangle Solver applet 9-1
  - TRIG 14-43
  - TRIGCOS 14-44
  - trigonometric
    - fit 10-13
    - functions 13-20
    - scaling 2-10, 2-14, 2-15
  - trigonometry functions
    - ACOS2S 14-38
    - ACOT 13-20
    - ACSC 13-20
    - ASEC 13-20
    - ASIN2C 14-39
    - ASIN2S 14-39
    - ASIN2T 14-39

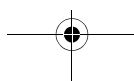



COT 13-20  
 CSC 13-20  
 HALFTAN 14-40  
 SEC 13-20  
 SIN COS 14-40  
 TAN2CS2 14-40  
 TAN2SC 14-41  
 TAN2SC2 14-41  
 TRIG COS 14-44  
 TRIG SIN 14-44  
 TRIG TAN 14-44  
 TRIG SIN 14-44  
 TRIG TAN 14-44  
 TRUNC 14-28  
 truncating values to decimal places  
 13-17  
 TSIMP 14-70  
 tstep 21-36  
 Two-Proportion Z-Interval 11-17  
 Two-Proportion Z-Test 11-11  
 Two-Sample T-Interval 11-19  
 Two-Sample T-test 11-14  
 Two-Sample Z-Interval 11-16  
 typing letters 1-6

## U

UNASSIGN 14-15  
 UNASSUME 14-61  
 undefined  
   name R-21  
   result R-21  
 un-zoom 2-11  
 upper-tail chi-squared probability  
 13-13  
 upper-tail normal probability 13-13  
 upper-tail Snedecor's F 13-13  
 upper-tail student's t-probability  
 13-14  
 USB connectivity 22-5  
 user defined  
   regression fit 10-13

## V

value  
   recall 17-3  
   storing 17-2  
 variables  
   aplet 17-1

CAS 14-4  
   categories 17-7  
   clearing 17-3  
   definition 17-1, 17-7, R-2  
   in equations 7-10  
   in Symbolic view 2-3  
   independent 14-6, 21-36  
   local 17-1  
   previous result (Ans) 1-23  
   printing 21-26  
   root 21-34  
   root-finding 3-10  
   step size of independent 21-36  
   types 17-1, 17-7  
   use in calculations 17-3  
 variation table 14-27  
 VARS menu 17-4, 17-5  
 vectors  
   column 18-1  
   cross product 18-11  
   definition of R-2  
 VER 14-70  
 verbose 14-6  
 version 14-70  
 views 1-18  
   configuration 1-18  
   definition of R-3

## W

warning symbol 1-8  
 where command ( | ) 13-18

## X

Xcross variable 21-36  
 XNUM 14-32  
 XQ 14-32

## Y

Ycross variable 21-37

## Z

Z-Interval 11-15  
 zoom 2-17  
   axes 2-12  
   box 2-9  
   center 2-9  
   examples of 2-11  
   factors 2-13

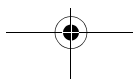



in 2-9  
 options 2-9, 3-8  
 options within a table 2-18  
 out 2-9  
 redrawing table of numbers op-  
 tions 2-18

square 2-10  
 un-zoom 2-11  
 within Numeric view 2-18  
 X-zoom 2-9  
 Y-zoom 2-10

